

The No. 1 for Garden Sheds, Boxes, Planting Beds & More



STORAGE
THE ORIGINAL
SOLUTIONS

HighLine® Size H2, Metallic Quartz Grey
(with aluminium floor frame, aluminium floor panels, double door, door baskets and BikeHolder as accessories)



 100% MADE IN AUSTRIA | PRODUCT CATALOGUE 2024



Your continuing
satisfaction is our
prime concern here
at Biohort.

Dear Customer,

Biohort products offer you the best quality, functionality and security. Our customers especially appreciate the durability and low maintenance of our storage solutions.

Biohort garden sheds have proven their durability in over 30 years of outdoor service. We are an Austrian manufacturing company with highly-trained and skilled workers. Biohort uses only top-quality materials from tested suppliers to manufacture its products. The high-quality steel we use is supplied by the same worldwide renowned Austrian and German steelworks in which German premium car manufacturers place their trust. This is the reason why we can offer our customers a 20-year guarantee against corrosion with a clear conscience.

Let Biohort help you realise your gardening dreams without a care in the world: with the SmartBase and SmartBase^{PLUS} foundation solutions, free delivery and installation service, completes our offer to a real complete solution. Find out more on page 5.

Sophisticated design and the high Austrian quality standard applied in the manufacturing process creates products that you will enjoy for decades.

We personally vouch for this.

A handwritten signature in blue ink that reads "J. Priglinger".

Dr. Josef Priglinger
Managing Director

A handwritten signature in blue ink that reads "Priglinger".

Dipl.-Ing. Maximilian Priglinger, MLS^{WU}
Managing Director

4 About Biohort

8 Garden Sheds

- 10 Neo
- 12 HighLine®
- 14 Panorama®
- 16 AvantGarde®, AvantGarde®ECO
- 18 Europa
- 20 Equipment Locker
- 22 Accessories
- 26 BikeLift®
- 28 Foundation Solutions, SmartBase / SmartBase^{PLUS}



32 Outbuilding **CASA NOVA**



34 Outdoor Boxes

- 36 Patio Locker Romeo®
- 38 StoreMax®
- 40 HighBoard
- 42 LoungeBox®
- 44 StyleBox®
- 46 LeisureTime Box



48 Bicycle Storage

- 50 MiniGarage
- 52 StoreMax®
- 54 HighBoard
- 26 BikeLift®



56 Dustbin Storage

- 58 Alex®
- 60 StoreMax®
- 62 HighBoard



64 Planting Beds

- 66 Raised Bed
- 68 Planting Bed Belvedere®
- 70 Accessories
- 72 Planter Box System DaVinci®



74 Gardening Helpers

- 76 Privacy Screen
- 78 Composter MonAmi®
- 79 Robotic Lawn Mower Garage Charly®
- 80 WoodStock®



82 Detailed Information

- 82 Quality and Sustainability
- 84 Technical Data
- 96 QR Code Pricing Information



Free Delivery

Dispatched within 2 to 4 days!* We will deliver your order free of charge directly to your home address (delivery free kerbside). The given address must be accessible for a 38-t lorry (3m minimum width of access).

*for stocked items, except outbuilding CasaNova®



Assembly Service

Biohort will be delighted to help you find an assembly partner who will assemble your purchase professionally. You can find more information on installation and the recommended prices at:

www.biohort.com/assembly-service



Assembly Videos

To help with the assembly, we have created short assembly videos for many of our products. You can find them on our YouTube channel:

www.youtube.com/biohort



The Biohort All-Around Service Package

All-In-One Solution

We guarantee our customers long-lasting satisfaction with our high-quality, durable products. In addition, we also offer you a complete service package. Our **customer service department** will always deal with your concerns personally as quickly as possible - regardless of the size of the concerned product.

Through our trained **installation partners**, we can also guarantee the comfort of a professional installation. The **foundation solutions** SmartBase and SmartBase^{PLUS} are available for all shed types and are built faster and cleaner than expensive concrete foundations. Together with our online tools such as the **product configurator**, Biohort offers the most complete service on the market!



Foundation Solutions

The foundation solutions SmartBase and SmartBase^{PLUS} form a stable foundation for Biohort garden sheds, the Equipment Locker and MiniGarage. The foundations are storm-proof and quick to install.

More information on pages 28 – 31 and at:

www.biohort.com/foundation



Product Configurator

The Biohort 3D-Configurator visualises within a few clicks each product including the individually desired accessories and even calculates the final price. Not enough: the handy augmented reality function allows you to virtually position the product directly in your garden via smartphone or tablet.

www.biohort.com/configurator



Factory 3 St. Martin i. M.



Factory 1 Neufelden



Factory 2 Herzogsdorf

Everything **Made in Austria**

Biohort has always produced in Austria, and we are very proud of this fact. There are now three large sites in the western Mühlviertel region of Upper Austria. We have deliberately chosen this

region with a highly skilled workforce. This enables us to produce in the best possible quality.

This is What We Stand For!



Quality

- 20 year guarantee, see page 82 for details
- Hot-dipped galvanised, polyamide coated steel
- Screws and hinges made of stainless steel
- Lifetime maintenance free
- Rainwater proof
- Production in Austria



Stability

- Double the plate thickness compared to low-cost providers
- Optimal constructional design
- Storm proof up to 150 km/h, wind force 12*
- High snow load* of up to 150 kg/m²



Functionality

- Extensive range of standard equipment
- User friendly
- Large selection of accessories
- Wide range of applications



Service

- Home delivery included in the price
- Short delivery time
- Assembly manual with photos / 3D illustrations for easy assembly
- Consultation from the Biohort Service Team
- Assembly service available on request



Security

- Locking mechanism with a cylinder lock
- Fireproof

*Only applies to garden sheds when professionally assembled and anchored.

A Company With History:

The Beginnings of Biohort

In the 1970s, we produced garden sheds at the Normstahl plant in Niederwaldkirchen. Later, in 1994, Biohort GmbH was founded and in 1997, Dr. Josef Priglinger took over 100% of Normstahl's Biohort shares.

At the turn of the millennium, Biohort was already listed in most Austrian construction and DIY stores and became increasingly well-known in the German-speaking world. Through the years, Biohort established itself as the market leader in Europa.

Continuous Product Development

In the early days we produced various garden sheds, metal composters and planting beds. The garden shed Europa was presented in 1996 and is still a classic. More and more different models followed, almost every year Biohort surprises with a new idea. The current portfolio can be found in this catalogue. In addition to the development of new products, we are constantly improving and expanding our existing products. Innovation and quality are our top priorities!



Garden shed Europa in the beginning

FOR MORE **JOY** IN YOUR GARDEN





10 Neo



12 HighLine®



14 Panorama®



16 AvantGarde® & AvantGarde®ECO



20 Europa



22 Equipment Locker



32 CasaNova®



Neo Size 2B, Metallic Silver
 (with aluminium floor frame, aluminium floor panels and double door as accessories)

Neo

Revolution in Design & Functionality

The Best From Decades of Experience - The Biohort Top Product

Smooth wall surfaces and the elegant acrylic glass panel in the door characterise the modern look. Additional glass panels can be flexibly installed thanks to a specially developed panel system. To ensure a pleasant atmosphere, the wooden ceiling regulates the humidity along with the optional grey white interior panelling and insulation.



Metallic Silver

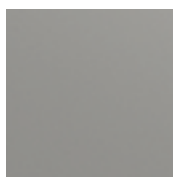

Metallic Quartz Grey



Metallic Dark Grey



Size 2B, Metallic Dark Grey with Side Canopy
 Back and side walls as privacy screens are available separately (see accessories, p. 24).
 Tip: The glass panel and FloraBoard are also available for the side canopy.

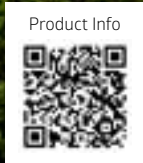

Advantages

Security:

- 3-way locking mechanism with stainless steel door handle
- Storm proof up to 150 km/h, wind force 12
- High snow load of up to 150 kg/m²
- Screw and rivet free surfaces

Functionality:

- Comfortable door opening with gas spring
- Optional interior panelling and insulation
- Integrated roof gutter

Standard Equipment:

- Tinted glass in the standard door
- Wooden ceiling made of 19 mm plywood with a 1.5 mm EPDM roofing membrane
- Rainwater downpipe (2 pcs.)
- Tool holder (2 pcs.)
- Tool hanger (2 pcs.)
- Shelves (2 pcs.)

Sizes (in cm, outer dimensions incl. roof overhang)

Door opening:

Standard door (right door hinge): 83 x 200 cm (W x H) - the standard door can be installed on the sides of the shed.

Double door: 167 x 200 cm (W x H) - the double door can be installed on the sides of the shed from 236 cm.

The blue bar markings on the gutters are there to indicate onto which side (from size 2A onwards) the optional side canopy can be attached. See page 24 for details.

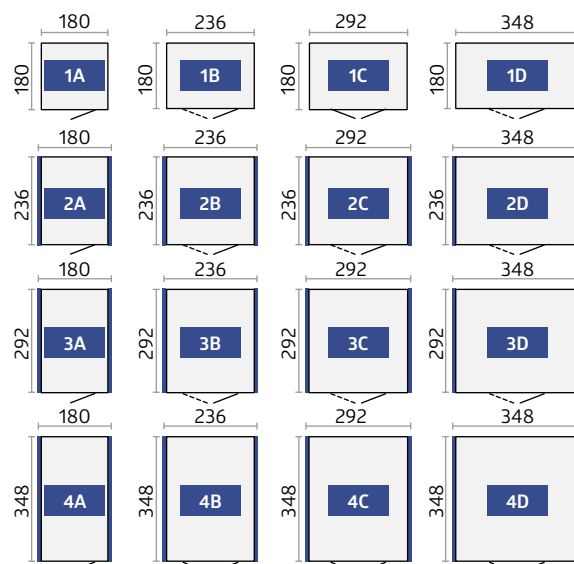

Technical data and detailed information can be found on pages 84 – 85.



Optional accessories can be found on pages 22 – 31.



HighLine® Size H2, Metallic Dark Grey
 (with aluminium floor frame, aluminium floor panels
 and double door as accessories)

HighLine®

An Example
 of Design and
 Technology

The Garden Shed HighLine® Fulfills the Highest Standards

Sophisticated industrial design in an impressive form: The modern flat roof and the integrated all-around skylight give the HighLine® strong accents. The 3-way locking mechanism with a robust cylinder lock ensures optimum security. The opening and closing of the door works semi-automatically with the help of a gas spring. The HighLine® shed is absolutely maintenance-free!



Metallic
Silver



Metallic
Quartz Grey



Metallic
Dark Grey

(Roof surface is always in metallic quartz grey)



HighLine® Size H3, Metallic Silver with Side Canopy

Back and side walls as privacy screens are available separately (see accessories, p. 24).



Advantages

Security:

- 3-way locking mechanism with stainless steel door handle
- Storm proof up to 150 km/h, wind force 12
- High snow load of up to 150 kg/m²

Functionality:

- Integrated gutter with a connection for a 1 1/4" hose
- Gutter with integrated leaf traps fitted to both sides
- Comfortable door opening with gas spring

Standard Equipment:

- 360° acrylic glass panels
- Tool holder (2 pcs.)
- Tool hanger (4 pcs.)
- Shelves and support rails (2 pcs. each)

Sizes (in cm, outer dimensions incl. roof overhang)

Door opening:

Standard door (right door hinge): 76 x 182 cm (W x H)
 Double door: 155 x 182 cm (W x H)

The blue bar markings on the gutters are there to indicate onto which side (from size H2 onwards) the optional side/front canopy can be attached. See page 24 for details. The dotted lines mark the roof overhang.

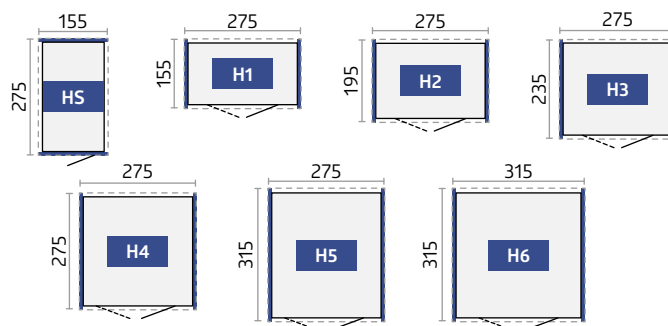

Tip: You can rotate the HighLine® from size H2 onwards to suit your own preferences, and the standard door can be installed in any side wall. From size H4 onwards, installing the double doors in the side wall is also possible.

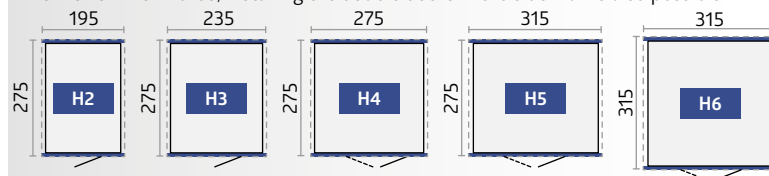

Technical data and detailed information can be found on pages 86 – 88.



Optional accessories can be found on pages 22 – 31.



Panorama® Size P2, Metallic Dark Grey
(with aluminium floor frame, aluminium floor panels
and FloraBoard as accessories)

Panorama®

Interior Illumination

The Beauty of Natural Light

The full encircling skylight constructed from acrylic glass gives our new garden shed Panorama® a lightness in appearance and allows this model with its modern gable-roof to fit easily into its surroundings. The proven Biohort quality of materials and workmanship together with the selection of individual equipment options and the range of sizes available make the Panorama® the perfect garden shed to meet your high demands.



Metallic
Silver



Metallic
Quartz Grey

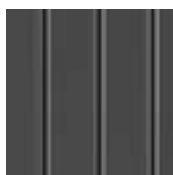

Metallic
Dark Grey



Size P2, Metallic Quartz Grey

The standard door can be fitted in any side wall from size P2 onwards.

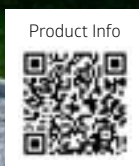
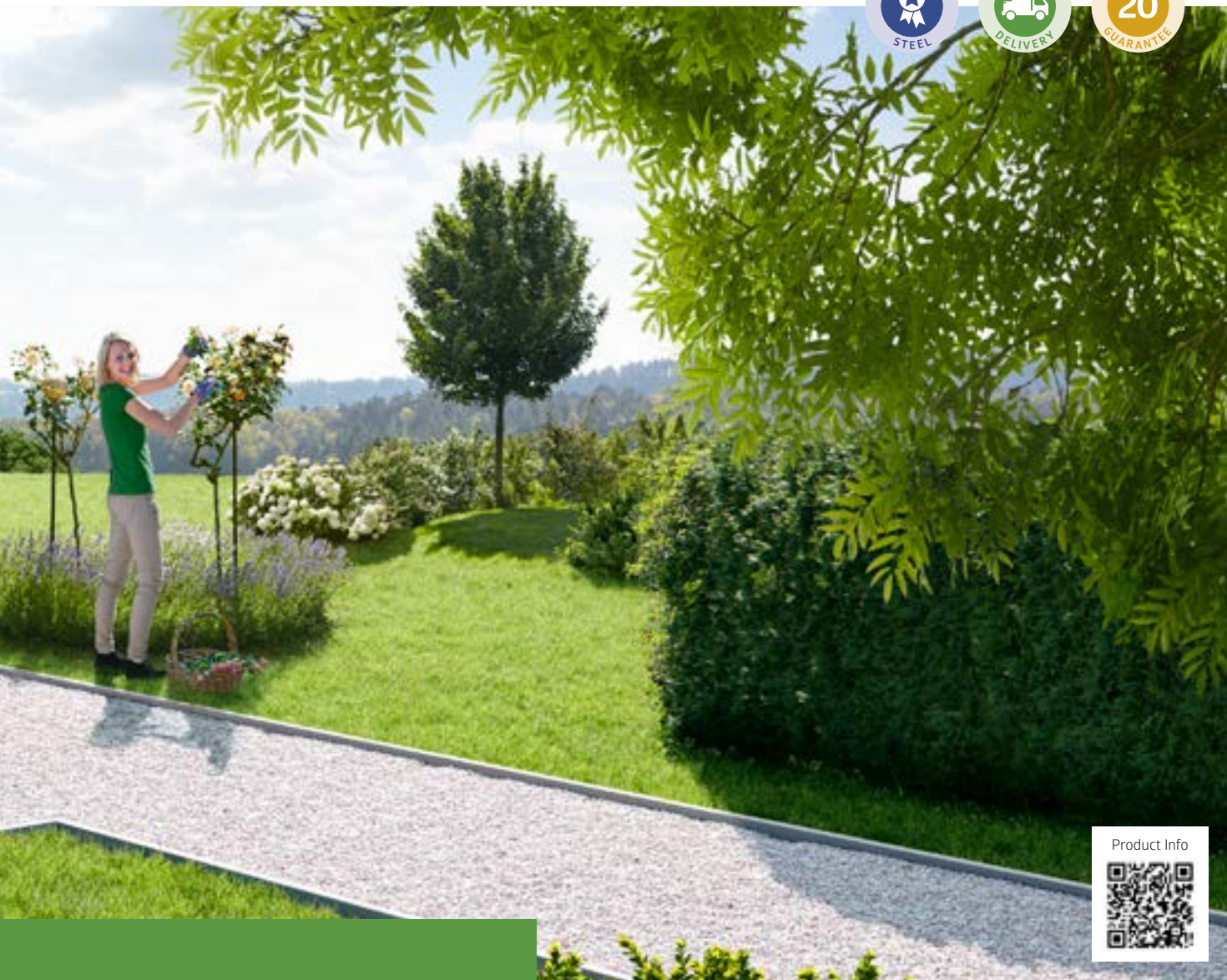

Advantages

Security:

- 3-way locking mechanism with stainless steel door handle
- Storm proof up to 150 km/h, wind force 12
- High snow load of up to 150 kg/m²

Functionality:

- Integrated gutter with a connection for a 1 1/4" hose
- Gutter with integrated leaf traps fitted to both sides
- Comfortable door opening with gas spring

Standard Equipment:

- 360° acrylic glass panels
- Tool holder (2 pcs.)
- Tool hanger (4 pcs.)
- Shelves and support rails (2 pcs. each)

Sizes (in cm, outer dimensions incl. roof overhang)

Door opening:

Standard door (right door hinge): 76 x 182 cm (W x H) - from size P2 onwards, the standard door can be installed in any side wall.

Double door: 155 x 182 cm (W x H) - from size P4 onwards, the double door can be installed in either side wall.

The dotted lines mark the roof overhang.

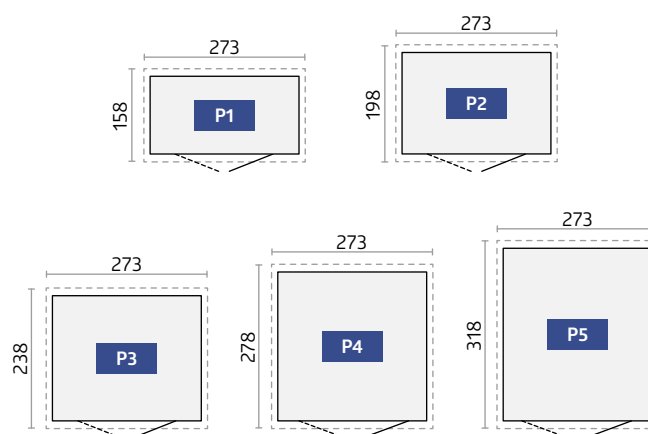

Optional accessories can be found on pages 22 – 31.

Technical data and detailed information can be found on pages 86 – 88.



reddot design award



AvantGarde® Size A5, Metallic Silver
(with smooth double door, aluminium floor frame and aluminium floor panels as accessories)



AvantGarde®

Modern
Architecture

Top Quality Pent Garden Shed

The AvantGarde® lives up to its name. It is an extremely stable metal garden shed that meets the demands of modern architecture. Its attractive appearance and the numerous practical advantages it offers for daily use will guarantee endless enjoyment. It is maintenance-free for life and therefore saves money and valuable spare time.



Metallic Silver



Metallic Quartz Grey



Metallic Dark Grey



Size A3, Metallic Dark Grey with Slim Double Door



AvantGarde® ECO

ECO Version at an Attractive Price!



Size A5 in the ECO Version, Metallic Quartz Grey with corrugated standard door

For particularly price-conscious buyers, we recommend the ECO version with corrugated door and T-handle cylinder lock.

With integrated organiser system on the inside of the door and door hooks instead of the gas spring. **The ECO version is supplied without the standard equipment, which makes it so attractive in price.** Door opening and sizes, just like the AvantGarde®. Also available with corrugated double door.

Advantages

Security:

- 3-way locking mechanism with stainless steel door handle / 2-way locking mechanism in the ECO Version
- Storm proof up to 150 km/h, wind force 12
- High snow load of up to 150 kg/m²

Functionality:

- Integrated gutter with a connection for a 1 1/4" hose
- Acrylic glass skylight with roof overhang

Standard Equipment*:

- Tool holder (2 pcs.)
- Tool hanger (4 pcs.)
- Shelves and support rails (2 pcs. each)
- Comfortable door opening with gas spring

*not included in the ECO version

Sizes AvantGarde® and Avantgarde® ECO

(in cm, outer dimensions incl. roof overhang)

Door opening:

Standard door (right door hinge): 76 x 182 cm (W x H)

Double door A1 – A4: 139 x 182 cm (W x H)

Double door A5 – A8: 155 x 182 cm (W x H)

The dotted lines mark the roof overhang.

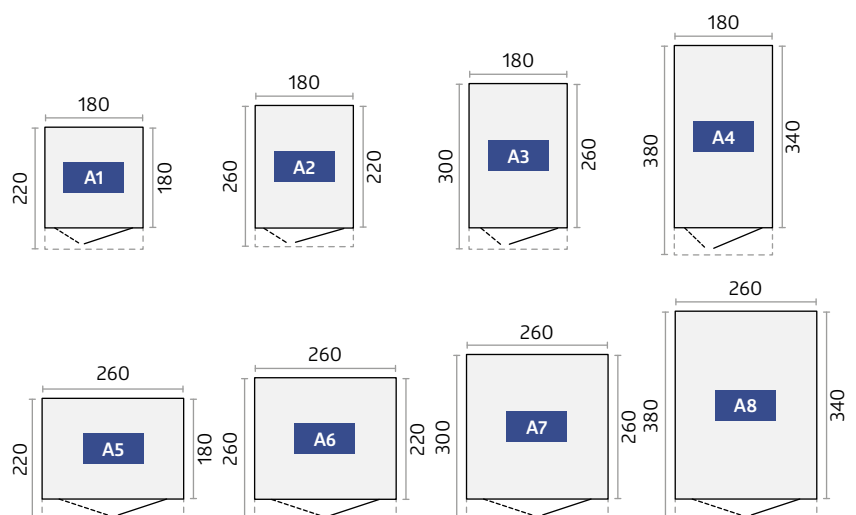



Europa Size 3, Metallic Quartz Grey
 (with aluminium floor frame and aluminium floor panels as accessories)

Europa

Quality at a Reasonable Price

Everything Well Organised with the Biohort Classic

Proven and tested for decades and still very popular! More than 150,000 units of the Europa appliance house have been sold and the proud owners enjoy them. The high stability, durable materials and free maintenance are the reasons why. The functional features simplifies your gardening work and establishes order in your garden. An extensive range of standard features and sophisticated accessories fulfil your needs.



Metallic Silver



Metallic Quartz Grey



Metallic Dark Grey



Dark Green



Size 4, Metallic Dark Grey with Side Canopy
 (see accessories p. 24)

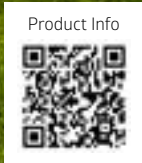

Advantages

Security:

- 2-way locking mechanism with T-handle cylinder lock
- Storm proof up to 150 km/h, wind force 12
- High snow load of up to 150 kg/m²

Functionality:

- Integrated gutter with a connection for a 1" hose

Standard Equipment:

- Double door
- Integrated organiser system on the inside of the doors (incl. 6 hooks)
- Tool hanger (4 pcs.)
- Shelves and support rails (2 pcs. each)
- Two additional mounting brackets for wall mounting (by size 2A and size 4A)
- Door hooks to secure the opened door panels

Sizes (in cm, outer dimensions incl. roof overhang)

Door opening:

Double door: 135 x 170 cm (W x H) - from size 2A an off-centre installation of the double door possible, for sizes 2, 3, 4, 5, 6 and 7 side installation of the double door possible.

The dotted lines mark the roof overhang.

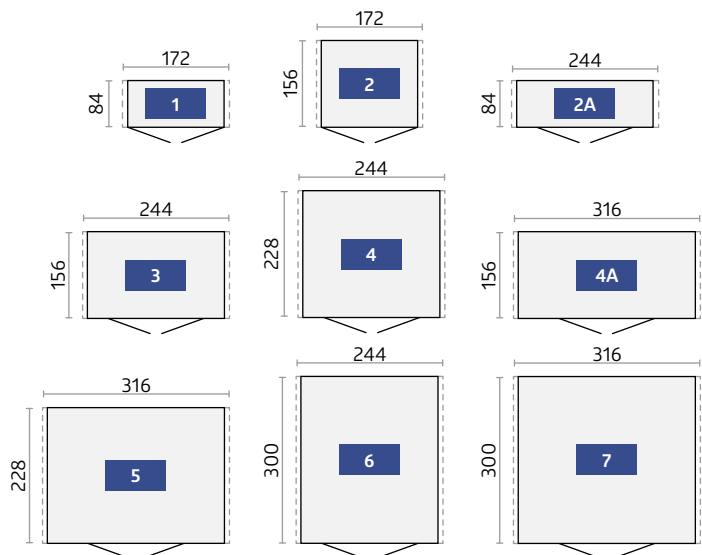

Optional accessories can be found on pages 22 – 31.

Technical data and detailed information can be found on pages 88 – 89.



Equipment Locker Size 230, Metallic Quartz Grey
(with aluminium floor frame and aluminium floor panels as accessories)

Equipment Locker

Small but Versatile

Attractive and Highly Versatile Locker

Where room is scarce, the Equipment Locker shows its value. In the garden, on the terrace, in the garage or on the balcony it organises and stores your tools without restricting your living space. With the Biohort Equipment Locker you can store garden equipment, barbecue grills, garden furniture, and other similar items protected from rain and theft. It blends harmoniously into its location thanks to seven different sizes and its elegant design.



Metallic Silver



Metallic Quartz Grey

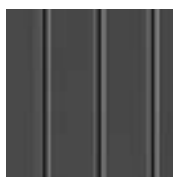

Metallic Dark Grey



Size 90, Metallic Dark Grey
with Aluminium Floor Frame and Floor Panels
as accessories

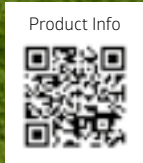
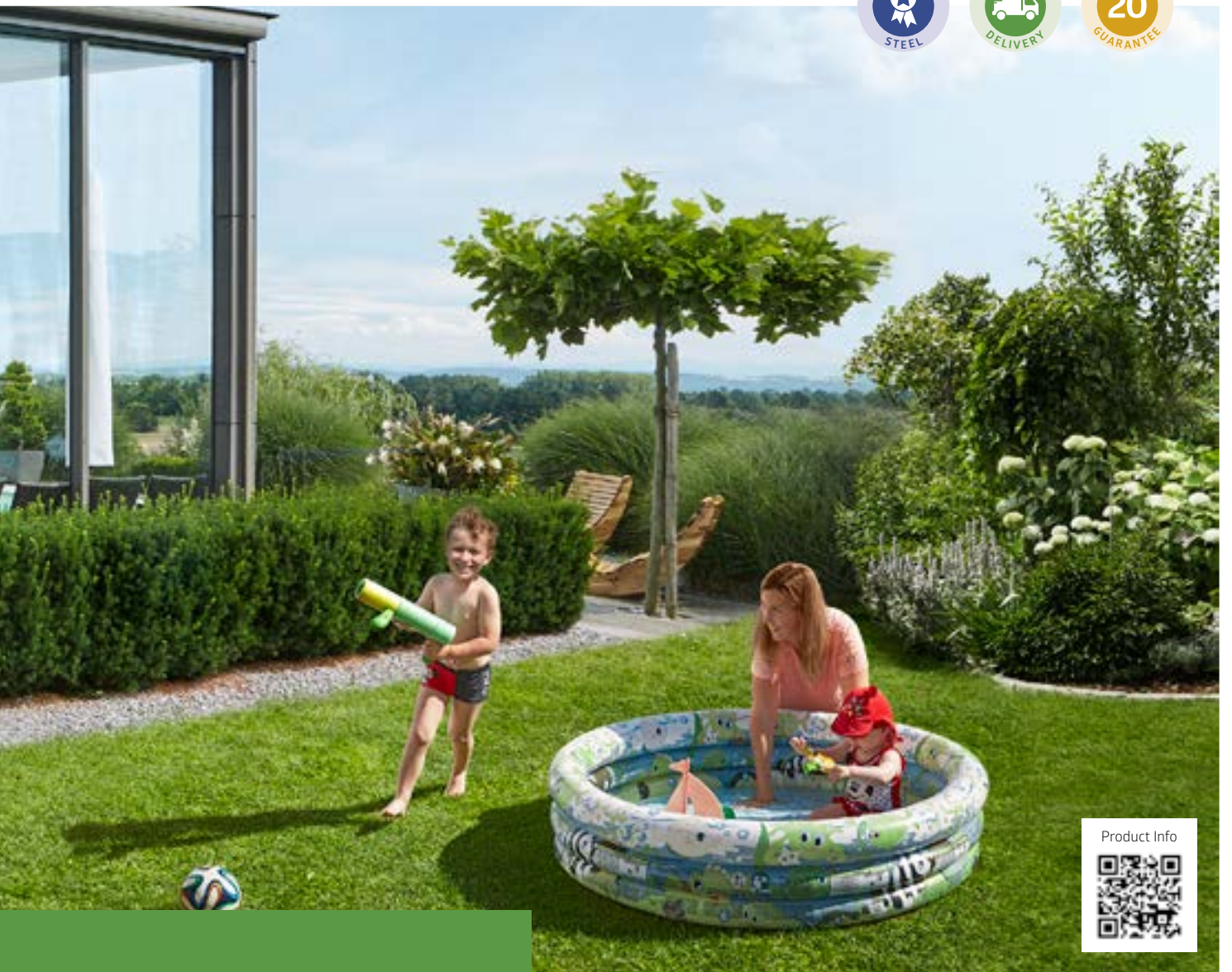

Advantages

- Invisible, integrated ventilation
- Rainwater proof

Security:

- 2-way locking mechanism with T-handle cylinder lock
- Fireproof

Standard Equipment:

- Double door (from size 150)
- Integrated organiser system on the inside of the doors (incl. 6 hooks)
- Tool hanger (4 pcs.)
- Shelves and support rails (2 pcs. each)
- Door hooks to secure the opened door panels

Sizes (in cm, exterior dimensions)

Door opening:

Size 90: 65 x 170 cm (W x H), size 150 – 230: 135 x 170 cm (W x H)

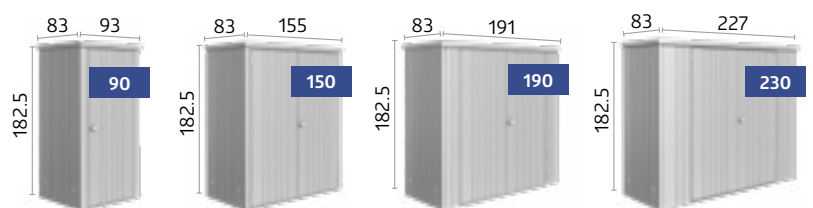

Double Depth Sizes (in cm, exterior dimensions)

Door opening:

135 x 170 cm (W x H)

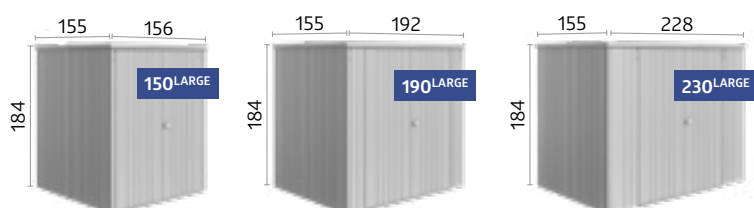

Optional accessories can be found on pages 22 – 31.

Technical data and detailed information can be found on pages 88 – 89.

✓ **Standard Equipment**

★ **Optional Accessories**

	Neo**	HighLine®	Panorama®	AvantGarde®	AvantGarde®ECO	Europa	Equipment Locker
01 Shelf Support Rails For mounting accessories such as shelves, shelf baskets, hook set, suspension basket and folding table. Standard equipment: 2 support rails. (exception garden shed Neo: no support rails are required here, garden shed AvantGarde®ECO: no standard equipment)		✓ ★	✓ ★	✓ ★	★	✓ ★	✓ ★
02 Shelves Shelves with a depth of 24.5 cm or 43.5 cm are suspended in 2 support rails*. (2 pieces per package) (exception garden shed Neo: shelves of 26 cm or 44.5 cm depth.) Load capacity: 15 kg per shelf. Standard equipment: 2 shelves (exception garden shed AvantGarde®ECO: no standard equipment)	✓ ★	✓ ★	✓ ★	✓ ★	★	✓ ★	✓ ★
03 Tool Hangers To hang up spades, rakes, garden hoses and other garden tools. (Load capacity: 10 kg). Standard equipment: 4 tool hangers (exception garden shed Neo: 2 pieces, garden shed AvantGarde®ECO: no standard equipment)	✓ ★	✓ ★	✓ ★	✓ ★	★	✓ ★	✓ ★
04 Tool Holder For mounting on the interior of the door. A maximum of 4 tool holders can be fitted to the door panel. Standard equipment: 2 tool holders (exception garden shed AvantGarde®ECO: no standard equipment)	✓ ★	✓ ★	✓ ★	✓ ★	★		
05 Door Baskets The door baskets can be easily fixed onto the inside of the door. Ideal for storing garden tools, gloves etc. with in easy reach (2 pieces per package). Size (W x L x H): 37 x 10 x 9.5 cm, load capacity: 1 kg per door basket	★	★	★	★	★	★	★
06 Shelf Baskets Shelf baskets are suspended in 2 support rails. Ideal for storing pesticides, lawn seeds, tins and tools. (2 pieces per package). Size (W x L x H): 72 x 16 x 11 cm, load capacity: 3 kg per shelf basket	★	★	★	★	★	★	★
07 Hook Set Consists of a combination hook, a handle hook and a shovel hook on a wall rack that is hung between 2 support rails*.	★	★	★	★	★	★	★
08 Suspension Basket Ideal for storing small objects, includes wall bracket for hanging between 2 support rails*. Sack made of black polyester mesh. Size (W x L x H): 67 x 34 x 20 cm (exception garden shed Neo: 55 x 34 x 20 cm).	★	★	★	★	★	★	★
09 Folding Table The space-saving folding table is hooked into 2 support rails*. It quickly provides you with a stable work surface. Load capacity max. 30 kg, size (W x L): 69 x 58 cm.		★	★	★	★	★	★
10 Electric Mounting Panel Discreet, hidden cable routing and easy assembly of switches and outlets (electrical equipment in photo not included).	★	★	★	★	★	★	★
11 LED Light Battery-powered light with motion sensor and permanent light switch; magnetic fixation possible; including USB charging cable.	★	★	★	★	★	★	★
12 Rainwater Downpipe Set Two downpipes with outlet elbows in the same colour as the shed.	✓	★	★	★	★	★	
13 Interior Panelling Grey white interior wall panels are simply hooked into the side walls and screwed in place.	★						
14 Insulation The interior wall panelling can also be fitted with 40 mm thick insulation (styrofoam boards), which opens up many new possibilities for the garden shed.	★						

*Support rails not included in the delivery (exception garden shed Neo: no shelf support rails are needed).

**Attention: Garden shed Neo does not have any corrugations like the other garden sheds, this has not been taken into account in the illustration.



01 Support Rails
02 Shelves



03 Tool Hanger



04 Tool Holder



05 Door Baskets



07 Hook Set



08 Suspension Basket



06 Shelf Baskets



09 Folding Table



10 Electric Mounting Panel



11 LED Light



12 Rainwater Downpipe Set



13 Interior Panelling for
Garden Shed Neo



14 Insulation for Garden Shed Neo
(invisible)

✓ **Standard Equipment**

★ **Optional Accessories**

		Neo	HighLine®	Panorama®	AvantGarde®	AvantGarde®ECO	Europa	Equipment Locker
15	<p>FloraBoard Two rails of the same colour as the shed are attached to the outer wall and the flower boxes can be hung on these at a suitable height. Plastic inserts for easier planting are included in the standard delivery scope. Tip: For the garden shed Neo, the FloraBoard is also available for the side canopy with side or back wall.</p>	★	★	★	★	★		
16	<p>Window Unit The side wall panel with its metal-frame hinged window (plexiglass) brings even more daylight into the garden shed and provides a clear view of the garden (window opening: 50 x 60 cm).</p>		★	★	★	★	★	
17	<p>Glass Panel The tinted glass panel is enclosed in a metal frame (Dimensions: 28 x 207 cm) and can be flexibly installed in any side wall, but not next to a door, a corner element or another glass panel. Tip: The glass panel is also available for the side canopy with side or back wall.</p>	★						
18	<p>Gas Spring Set Provides a comfortable door opening. Standard equipment: 2 pieces (except garden shed AvantGarde®ECO, Europa and Equipment Locker). Also available as an optional accessory for garden shed AvantGarde®ECO.</p>	✓	✓	✓	✓	★		
19	<p>Double Door Makes entering and leaving the shed with large tools and equipment easier. The double door panel is equipped on the inside with a rotary lock and with a gas spring (Exception: Garden shed AvantGarde®ECO, Europa and Equipment Locker). Garden shed Neo: standard with glass panel in the right-hand door panel. (Exception: Equipment Locker size 90 no double door available).</p>	★	★	★	★	★	✓	✓
20	<p>Additional Door Included in the delivery scope are a stainless steel door handle with standard cylinder, a 3-way locking mechanism, a gas spring, hinges, two tool holders as well as the necessary metal fittings for the hinge positions. The door can be hinged* on the right and on request also on the left. Garden shed Neo: standard with tinted glass panel.</p> <p>Garden shed AvantGarde®ECO: Door also available in the more cost-effective ECO version, corrugated surface, with T-handle cylinder lock, incl. 2-way locking mechanism, door hooks, hinges and organiser system on the inside of the door</p> <p>Garden shed Europa: double door, corrugated surface, with T-handle cylinder lock, incl. 2-way locking mechanism, door hooks, hinges and organiser system on the inside of the door</p>	★	★	★	★			★
21	<p>Side Canopy The side canopy can be attached to the garden shed Neo (from size 2A onwards) on either one or both sides. The width of the side canopy is 300 cm. The aluminium supports are equipped with height-adjustable feet. Two rainwater downpipes are included.</p> <p>The side canopy is fixed to the HighLine® shed (from size H2) on the side with the rain gutter (optionally on one or both sides). It is available in two different sizes. The width of the side canopy size S is 150 cm and for size L 282 cm. The aluminium supports are equipped with height-adjustable feet. The rainwater downpipe is included.</p> <p>The side canopy for the garden shed Europa can be attached either to the left, to the right or to both sides of the shed. The set includes the supports, a short rainwater downpipe and the fixation material (not available for size 1 and size 2A).</p>	★						★
22	<p>Side and Back Walls for Side Canopy You can attach a back wall and/or a side wall to the side canopy of your HighLine® shed (from size H2)/ Neo (from size 2A). They are available in the same colours as the shed.</p>	★	★					

*Exception garden shed Neo: Here the door hinge is only possible on the right.



15 FloraBoard



16 Window Unit



17 Glass Panel for Garden Shed Neo



18 Gas Spring Set



19 Double Door / 20 Additional Door



21 Side Canopy
Garden Shed Neo



21 Side Canopy
Garden Shed HighLine® / Europa



22 Side and Back Walls for Side Canopy
Garden Shed HighLine®



22 Side and Back Walls for Side Canopy
Garden Shed Neo



Check your bike: www.biohort.com/bikelift

The BikeLift® Advantages

-  bike lockable
-  lift function for bikes weighing up to 30 kg
-  suitable for tyre widths of up to 77 mm/ 3 inch

The Biohort BikeLift® can be mounted on the wall in the cellar, in the garage or carport in just a few easy steps. It is even easier to install in a Biohort shed – the BikeLift® is simply hooked in there as an optional accessory.

The innovative lift is available in two variants:
 Standard or with Swivel Mount

Comfortable lift function for every bike

From e-mountain bike to racing bike – the Biohort BikeLift® pulls any bike vertically up the wall as if by itself. This saves space and is effortless.



Hook in

Simply hook the front wheel into the BikeLift®. The hook fits all tyre widths up to 77 mm.

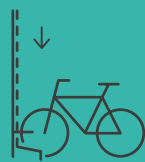

Push

A short downward push on the handlebars is enough to activate the automatic lift function.



Lift

Thanks to its strong spring force, the BikeLift® pulls every bike up to a weight of 30 kg as if by itself.



Save space

Securely fixed and lockable, the bike hangs vertically on the wall to save space.

★ Optional Accessories

		Neo**	HighLine®	Panorama®	AvantGarde®	AvantGarde®ECO	Europa	Equipment Locker
23	BikeLift® Standard The mechanical bicycle lift is simply hooked into the wall profiles and is suitable for bicycles with an outer tyre diameter of up to 29 inches, a tyre width of max. 77 mm, a total height of the rim incl. tyre of max. 77 mm, a maximum bicycle length of 1.95 m and a maximum weight of 30 kg. The end of the rear mudguard and the luggage carrier must not protrude beyond the tyre. Integrated locking eyelet for bicycle locks.	★	★	★	★	★	★	
24	BikeLift® with Swivel Mount For even more space saving, the bike can be folded to the side of the wall thanks to the device. In the garden shed Europa, the BikeLift® with swivel mount can only be mounted centrally on the rear wall.	★	★	★	★	★	★	
25	Threshold Access Ramp For outside and inside, for convenient crossing of the threshold, only possible with aluminium floor frame and double door. Load bearing capacity of max. 200 kg, length: 135 cm (exception garden shed Neo: 163.5 cm).	★	★	★	★	★	★	
26	Bicycle Hanger BikeMax Garden Shed Europa: height-adjustable in 6 different positions, for bicycles up to 26 inches, with a tire thickness of max. 5 cm and a weight of max. 25 kg. Garden shed Neo, HighLine®, Panorama®, AvantGarde® and AvantGarde®ECO: height-adjustable in 8 different positions and suitable for bikes with up to 29" wheels. Integrated locking eyelet for bicycle locks.	★	★	★	★	★	★	
27	BikeHolder Optimal storage of bicycles thanks to the adjustable retaining clamps. The base plate can be easily slotted into 2 support rails*. Quick and easy securing of the bicycle tyres for a maximum of 3 bicycles per BikeHolder.	★	★	★	★	★	★	

*Support rails not included in the delivery (exception garden shed Neo: no shelf support rails are needed).

**Attention: Garden shed Neo does not have any corrugations like the other garden sheds, this has not been taken into account in the illustration.



23 BikeLift® Standard



24 BikeLift® with Swivel Mount



25 Threshold Access Ramp



26 Bicycle Hanger BikeMax



27 BikeHolder

Technical data and detailed information can be found on pages 84 – 89.

Conventional Foundation Solutions

More information in foundation brochure and at: www.biohort.com/foundation

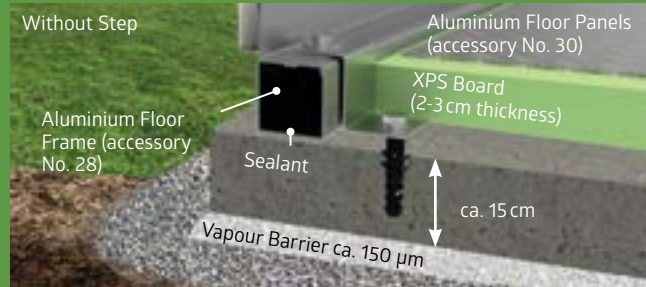

Concrete Foundation

A reinforced concrete foundation slab on a gravel base is an optimal, but also expensive foundation. With this type of foundation, you must also make sure that no water can penetrate into the shed at ground level. The offset foundation with a circumferential step of 2 cm x 7 cm is the ideal design for this (aluminium floor frame and aluminium floor plate cannot be used).

As an alternative to the stepped concrete foundation slab surface, a continuous flat concrete slab can also be poured. The **aluminium floor frame**, available as an accessory, facilitates the levelling of any uneven surface. The aluminium floor frame also allows the use of the **aluminium floor panels** and an underlayment with XPS rigid foam boards (not included).

Point Foundation

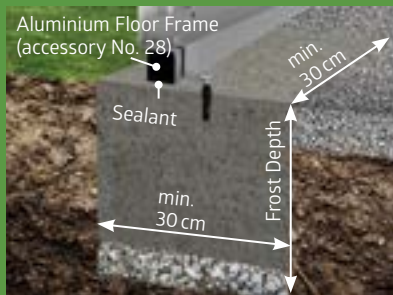

Another option for erecting garden sheds on uneven ground is a point foundation in conjunction with an **aluminium floor frame**.

Paving Slabs

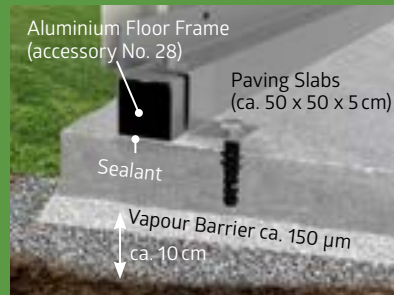

A good and inexpensive solution are paving slabs on a gravel base. We strongly recommend the use of the **aluminium floor frame**.

Floor Frame

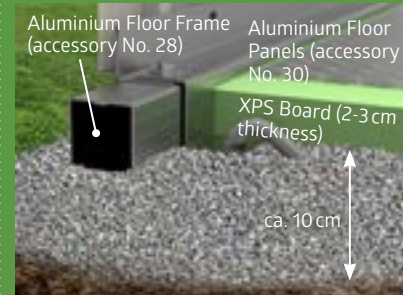

With the **aluminium floor frame**, you can also set up and anchor the shed on a gravel bed (floor anchors available as accessory). The **aluminium floor panels** serve as a functional floor and is underlaid with XPS hard foam boards (not included in delivery).

Biohort SmartBase Solutions

Detailed information on the SmartBase and SmartBase^{PLUS} can be found on pages 29 – 31.

★ Optional Accessories

		Neo	HighLine®	Panorama®	AvantGarde®	AvantGarde®ECO	Europa	Equipment Locker
28	<p>Aluminium Floor Frame</p> <p>It gives the shed the necessary stability even without a concrete foundation. If the floor frame is laid directly on a gravel base (approx. 10 cm gravel, without foundation or slabs), ground anchors are required for securing to the ground. These are available as accessories – please refer to the technical data for the number of anchors. Storm resistance must be ensured by the customer for this foundation solution.</p>	★	★	★	★	★	★	★
29	<p>Aluminium Floor Panels</p> <p>Depending on the size of the house, the high-quality aluminium chequer plate floor consists of several segments including connecting profiles. To ensure the optimal fitting, the aluminium floor frame is necessary (see above). Underlayment with a fill or XPS hard foam boards in a thickness of approx. 2-3 cm recommended (not included in the scope of delivery).</p>	★	★	★	★	★	★	★
30	<p>SmartBase</p> <p>The perfect floor for solid ground (concrete or paved surfaces). Light ground irregularities of up to 40 mm can be compensated. See details on next page.</p>	★	★	★	★	★	★	★
31	<p>SmartBase^{PLUS}</p> <p>Optimum solution for slopes and lawns, patented system with ground screws to compensate for slopes of up to 15 cm. See details on next page.</p>	★	★	★	★	★	★	★



28 Aluminium Floor Frame



30 SmartBase
Details see on next page.



29 Aluminium Floor Panels



31 SmartBase^{PLUS}
See details on next page.



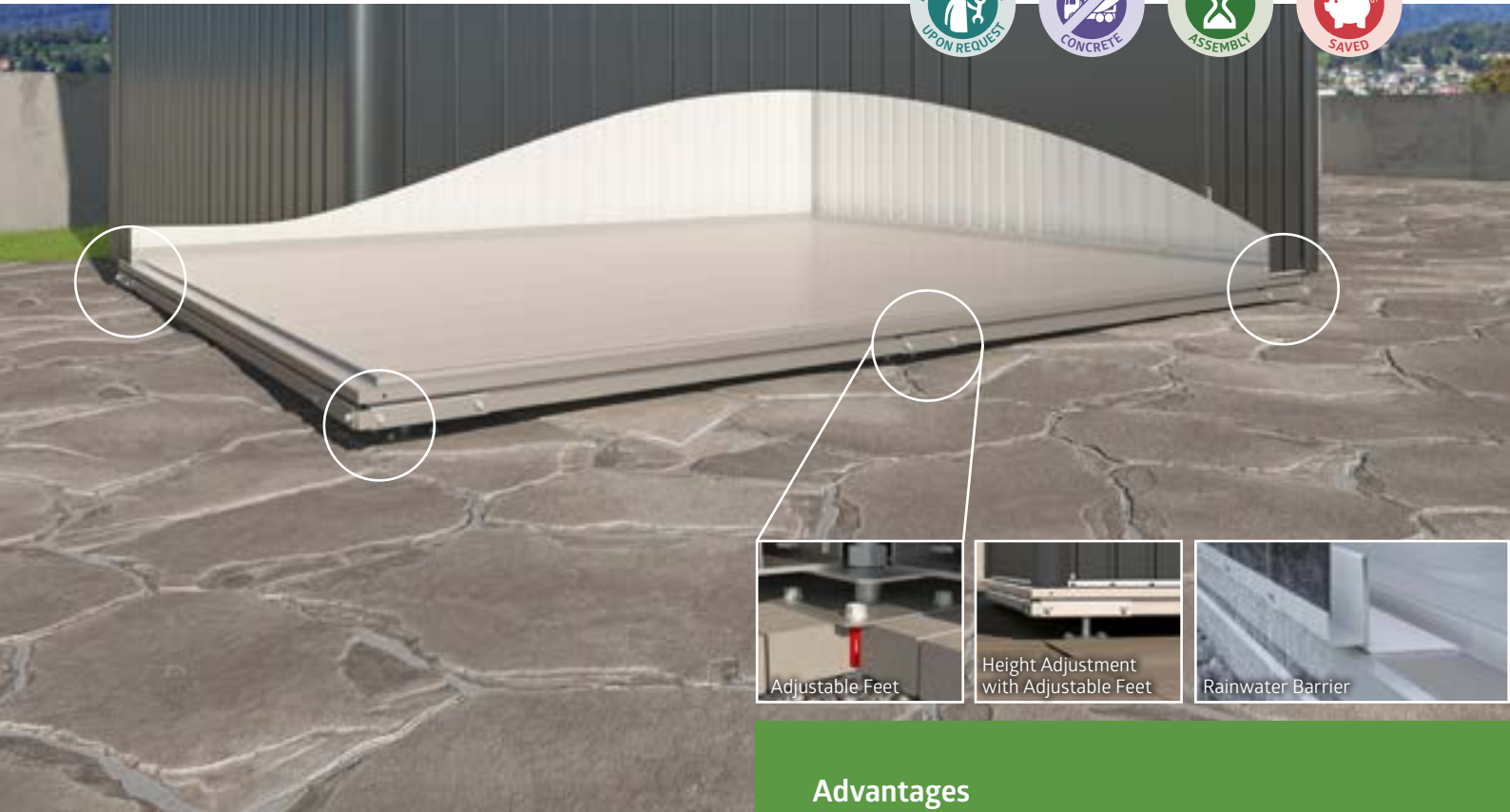

SmartBase

Perfect for Hard Surfaces

The Biohort SmartBase Foundation is the ideal foundation for concrete or paved areas. It consists of high-quality aluminium boards, a special foundation frame and height-adjustable feet. So light ground irregularities of up to 4cm can be compensated.

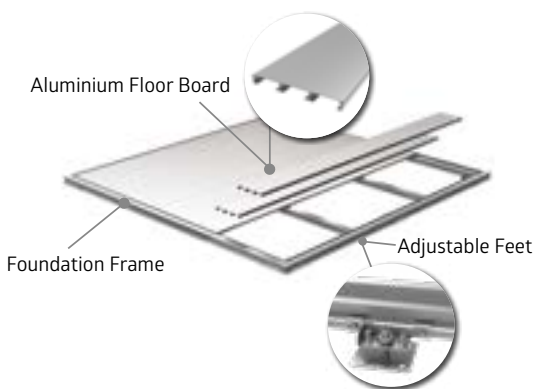

- Time of assembly:** 1 – 2 hours for two (depending on workmanship and product). **Tools required:** spirit level, drill, open ended spanner 13 and 24.
1. Frame assembly
 2. Connection of adjustable feet and frame alignment
 3. Fixing the adjustable feet to the subsurface
 4. Fixing of aluminium floor panels

Advantages

- Compensation of unevenness through adjustable feet
- Easy to remove if necessary
- Precisely fitted to all Biohort garden sheds, the Equipment Lockers and the MiniGarage
- Storm proof
- Load bearing capacity max. 200 kg/m²

Standard Equipment:

- Aluminium floor boards with grooved surface
- Specially designed foundation frame
- Galvanised adjustable feet
- Adjustable feet with height adjustment
- Integrated water barrier to protect against water ingress

Floor frame and floor plates are no longer necessary!

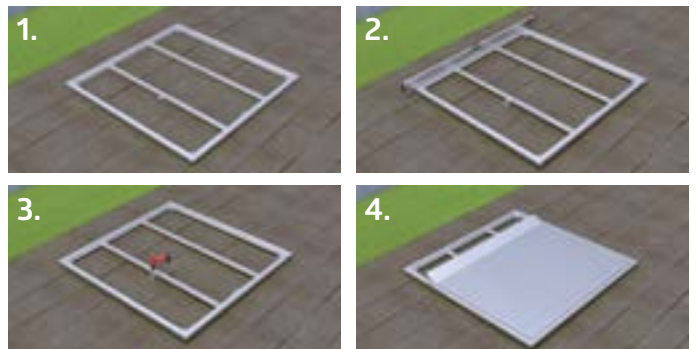



Height Adjustment with Ground Screws



Rainwater Barrier

SmartBasePLUS

Optimal Solution for Slopes and Lawns

Unlike the SmartBase foundation, the patented SmartBase^{PLUS} system includes ground screws instead of adjustable feet. These are screwed directly into the ground and can compensate for slopes of up to 15 cm (extensions are available on request for larger height differences). For this, the soil should be compact and free of large stones.

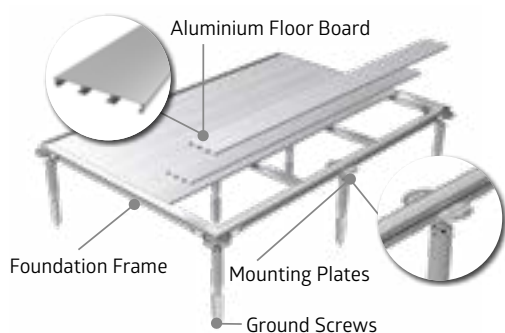

Advantages

- Little excavation
- Gravel base is not necessary
- Compensation of unevenness through ground screws
- Easy to remove if necessary
- Precisely fitted to all Biohort garden sheds, the Equipment Lockers and the MiniGarage
- Storm proof
- Load bearing capacity max. 200 kg/m²

Standard Equipment:

- Aluminium floor boards with grooved surface
- Specially designed foundation frame
- Galvanised ground screws
- Multi-adjustable mounting plates
- Including manual screw-in driver
- Integrated water barrier to protect against water ingress

Floor frame and floor plates are no longer necessary!

Time of assembly: 2 - 4 hours for two (depending on workmanship and product). **Tools required:** hammer drill, drill bit Ø 40 x 570 mm, spirit level, drill, open-end spanner 13 and 24, shovel.

1. Site preparation and ground screw insertion
2. Attachment and levelling of mounting plates
3. Positioning and attachment of frame
4. Fixing of aluminium floor panels





Optional Glass Elements

CasaNova® 3x5, Metallic Quartz Grey
(with aluminium floor frame, exterior lighting, two glass elements and double door as accessories)

CasaNova®

Design, Customised
to Your
Requirements

The High End Metal Building with Insulated Side Walls

Whether as a garden shed, workshop or sauna - the insulated design outbuilding Casanova® provides unique flexibility with a wide range of equipment options and adapts exactly to your ideas. No matter if you are looking for functional storage and place to store your plants during winter or if you want to establish an oasis of peace in your garden: with the CasaNova® you can make your wish come true at a unique quality level.



Metallic
Quartz Grey



Metallic
Dark Grey



Insulated Side Wall / Door Panel
Sandwich element with 40 mm polystyrene core (EPS W20)



Optional Double Glass Door

Advantages

- Sandwich element with 40 mm core made of polystyrene (EPS W20)
- Screw and rivet free surfaces

Security:

- Locking mechanism with stainless steel door handle
- Roof resp. snow load of up to 215 kg/m² (less roof loading such as greenery)

Functionality:

- Easy to heat thanks to thermal insulation; U-value of side walls: 0.76 W/(m²K)
- Door hinge position on the left or right available
- Large selection of accessories
- Ventilation via acrylic glass panel which can be opened
- Comfortable door opening with gas spring

Product Info



CasaNova Brochure

request via:
www.biohort.com



9 Sizes, 2 Colours and Countless Possibilities

Possible surface areas from 3 x 2 m to 4 x 6 m

Thanks to the modular construction, there are no limits to your wishes. Doors and windows can be positioned freely according to your expectations.

Configure your CasaNova® now!
www.biohort.com/configurator

Practical Details and Many Types of Applications



SPA and Wellness

CasaNova® 3 x 4, metallic dark grey with aluminium floor frame, 2 glass elements, external lighting and sauna as accessories



Car and Workshop

CasaNova® 3 x 5, metallic dark grey with overhead sectional door, additional door and tilt and turn window as accessories



Hobby and Sport

CasaNova® 3 x 4, metallic dark grey with aluminium floor frame, aluminium floor panels, double door, external lighting and two glass elements as accessories



Home Office and Retreat

CasaNova® 3 x 4, metallic dark grey with aluminium floor frame, 2 glass elements and external lighting as accessories



A QUESTION OF **STYLE**



36 Romeo®



38 StoreMax®



40 HighBoard



42 LoungeBox®



44 StyleBox®



46 LeisureTime Box



Patio Locker Romeo® Size M, Metallic Quartz Grey

Romeo®

Patio Locker

More Space for the Essentials

The Patio Locker Romeo® creates additional space without needing much space for itself. Moreover, it spoils all balcony and patio fans with an individual shelf range, soft-closing doors due to gas springs and many more details which are typical for Biohort!



Metallic Silver

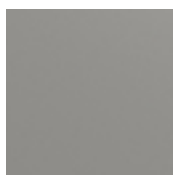

Metallic Quartz Grey



Metallic Dark Grey



Size L, Metallic Dark Grey



Advantages

- Rainwater proof
- Invisible, integrated ventilation

Security:

- 3-way locking mechanism with T-handle cylinder lock

Functionality:

- Comfortable door opening with gas spring

Standard Equipment:

- Shelves (2 pcs.) and support rails (3 pcs.)
- Organiser system fitted inside the door (incl. 6 hooks)

Product Info



Sizes (in cm)

Door opening:

103 x 131cm (W x H)

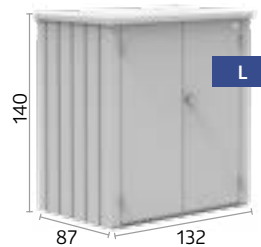
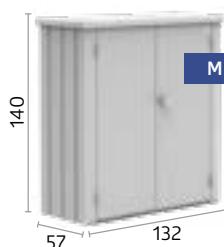

★ Optional Accessories



Shelves (2 pieces)

Galvanised steel shelves (61 x 43 cm) available in addition to the shelves which are part of the standard delivery scope.



StoreMax® Size 120, Metallic Quartz Grey

StoreMax®

Design Outside,
Space Inside

Gardening Joy at the Highest Level

A garden is a feel-good oasis – at least if it is tidy. This is why the StoreMax® offers maximum storage space in a small space, which can be individually divided up with shelves and shelving units. Whether as a lawn mower garage, garden tool box or storage space for pillows, behind the two-part opening system there is room for everything!



Metallic Silver



Metallic Quartz Grey



Metallic Dark Grey



The top shutter can be opened separately.



To fully open the StoreMax® the front shutter fully glides back.



Advantages

- Rainwater proof
- Shutter made from aluminium

Security:

- 2-way locking mechanism with T-handle cylinder lock

Functionality:

- Easy operation due to spring support

Standard Equipment:

- Tool holder on the inside of the side wall

OUTDOOR BOXES

Product Info



Sizes (in cm)

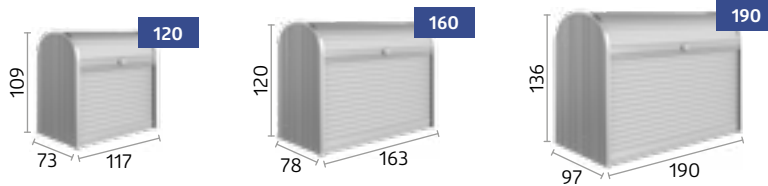

Optional Accessories



Corner Shelf Set (suitable for size 120 & 160)

2 shelves (triangular-shaped) with support rails, height adjustable in 5 different positions, easy to retrofit without any tools, can be fitted on the left or the right as required.



Shelf Set (suitable for size 190)

2 steel shelves (72 x 24.5 cm) and 2 support rails.



Intermediate Floor (suitable for size 160 & 190)

2-pieces, galvanised steel shelf with support rails, supports a load of ca. 100 kg; can also be used as a 2-piece shelf, height adjustable in 5 different positions, easy to retrofit.



HighBoard Size 160, Metallic Dark Grey
 (with tool holder and intermediate floor as accessories)

HighBoard

Highlight on the Patio

Multitalent for Storage

Thanks to the double doors and opening lid, the applications for the HighBoard are almost limitless: whether as a storage space for cushions and garden equipment or as the perfect extension to your outdoor kitchen, everything is protected from the weather and neatly stowed away. Its elegant design has been developed by industrial designers and is a guaranteed highlight on every patio.



Metallic Silver



Metallic Quartz Grey

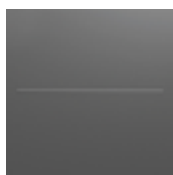

Metallic Dark Grey



Size 160, Metallic Quartz Grey with Intermediate Floor



Advantages

- Rainwater proof
- Invisible, integrated ventilation
- Screw and rivet free surfaces

Security:

- Locking mechanism with turn knob cylinder lock

Functionality:

- Comfortable lid opening with gas spring

Standard Equipment:

- Dustbin lid opener (3 pcs.)

OUTDOOR BOXES



Sizes (in cm)

Door opening:

Size 160: 140 x 100 cm (W x H)
Size 200: 167 x 110 cm (W x H)

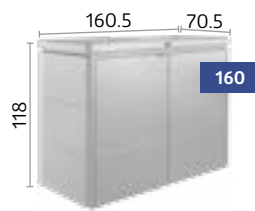

★ Optional Accessories



Suspension Basket

The sack made of black polyester mesh offers additional variable storage space and is simply hooked onto the frame. Load capacity max. 10 kg.



Tool Holder

For mounting on the inside of the doors. Max. 2 tool holders per door panel possible.



Intermediate Floor

In metallic silver, 9 position height adjustment. Easy to install and universally adaptable (e.g. as a continuous shelf or as 2 shelves). Load capacity max. 50 kg.



Lid Storage Net

The solution for small objects. It can be easily attached to the inside of the lid.



LoungeBox® Size 160, Metallic Dark Grey

LoungeBox®

Stylish Elegance

Design for High Standards

The LoungeBox® is the perfect storage solution for seat cushions and many other things for which one can never find a suitable place. Due to its appealing look, it blends in well on every patio.



Metallic Silver



Metallic Quartz Grey

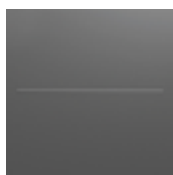

Metallic Dark Grey



Size 160, Metallic Dark Grey



Advantages

- Rainwater proof
- Invisible, integrated ventilation
- Lid made from aluminium
- Screw and rivet free surfaces

Security:

- Locking mechanism with turn knob cylinder lock

Functionality:

- Comfortable lid with gas spring

Product Info



Sizes (in cm)

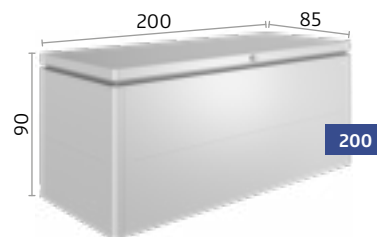
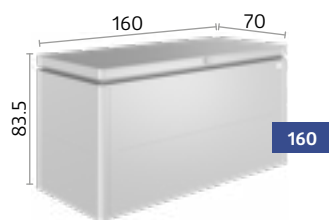

★ Optional Accessories



Suspension Basket

The sack made of black polyester mesh offers additional variable storage space and is simply hooked onto the frame. Load capacity max. 10 kg.



Lid Storage Net

The solution for small objects. It can be easily attached to the inside of the lid.



StyleBox® Size 170, Metallic Dark Grey

StyleBox®

For More Lifestyle

Storage as a Design Element

The new outdoor box presents itself in a high-quality and stylish way thanks to its smooth surfaces and flawless finish. The innovative push-fit system allows installation in less than 20 minutes. Whether on the terrace, the balcony or in the garden - the design fits perfectly into any environment.

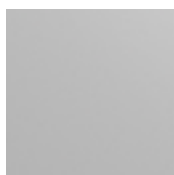

Metallic Silver

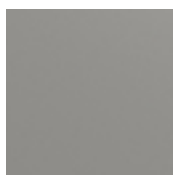

Metallic Quartz Grey



Metallic Dark Grey



Size 170, Metallic Quartz Grey with suspension basket and lid storage net



Advantages

- Rainwater proof
- Invisible, integrated ventilation
- Elegant design with smooth surfaces
- Quick assembly in under 20 minutes thanks to innovative push-fit system

Security:

- Lockable by means of padlock (lock not included)

Functionality:

- Comfortable lid with gas spring
- Practical snap lock

Standard Equipment:

- Four height adjustable feet for levelling on uneven floors

OUTDOOR BOXES



Sizes (in cm)

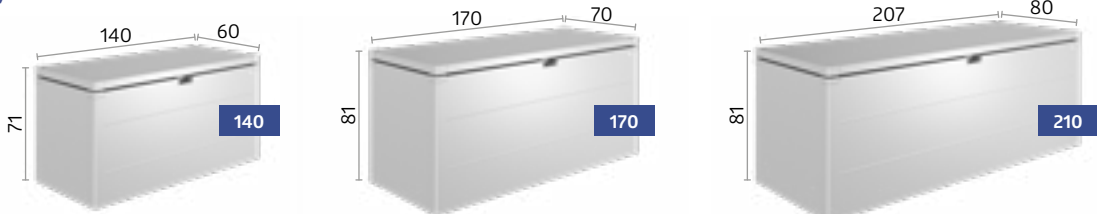

★ Optional Accessories



Suspension Basket
The sack made of black polyester mesh offers additional variable storage space and is simply hooked onto the frame. Load capacity max. 10 kg.



Castors
Two rubberised castors for moving the box.



Lid Storage Net
The solution for small objects. It can be easily attached to the inside of the lid.



LeisureTime Box Size 160^{HIGH}, Metallic Quartz Grey

LeisureTime Box

Stylish & Durable

The Perfect Box for Outside

It stores all those items you cannot find a suitable storage place for. Ideal for stowing away seat cushions, toys, sun loungers, folding chairs, sports and camping equipment. 5 sizes, 5 colours for every demand. The perfect long-lasting solution through the use of high-quality materials.



White



Metallic
Silver



Metallic
Quartz Grey



Metallic
Dark Grey



Metallic
Bronze



Advantages

- Rainwater proof
- Invisible, integrated ventilation

Security:

- 2-way locking mechanism with T-handle cylinder lock

Functionality:

- Comfortable lid with gas spring



Sizes (in cm)

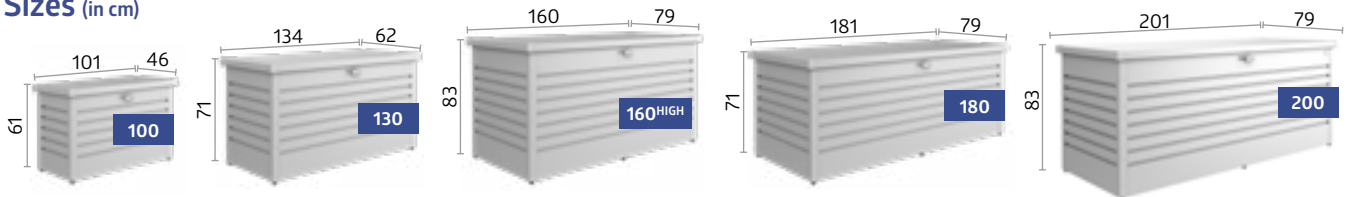

Tip: Also ideal as Parcel Box!

Optional Accessories



Suspension Basket

The sack made of black polyester mesh offers additional variable storage space and is simply hooked onto the frame. Load capacity max. 10 kg.



Lid Storage Net

The solution for small parts can be easily attached to the inside of the lid. Two nets can be fixed side by side in the LeisureTime Box 180.



Parcel Box Kit

Stainless steel locking bar and padlock with number combination and stainless steel securing cable.





OUT OF LOVE FOR YOUR BICYCLE



50 MiniGarage



52 StoreMax®



54 HighBoard

Tip: Biohort Garden sheds also offer enough space to store bicycles safely. For details, see page 8–27.



MiniGarage L Metallic Dark Grey
 (with aluminium floor frame, aluminium floor panels, bike rails, electrical mounting panel and shelf set as accessories)

MiniGarage

Small with
Big Benefits

Secure Bicycle Garage with Practical Details

The MiniGarage provides the ideal storage space for up to 2 bicycles or gardening tools and garden furniture. The intelligent rail system (optional) facilitates the storage of bicycles: Place the front wheel in the guide rail, push it to the back with the bicycle seat until the front wheel is in the clamp, done! The shelf set is ideal for storing additional bicycle accessories.

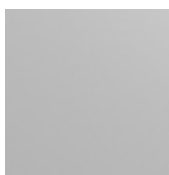

Metallic Silver



Metallic Dark Grey



Size L, Metallic Dark Grey
 with bicycle rail, electrical mounting panel and shelf set



Advantages

- Rainwater proof
- Invisible, integrated ventilation

Security:

- 3-way locking mechanism with T-handle cylinder lock

Functionality:

- Comfortable door opening with gas spring

Standard Equipment:

- Organiser system fitted inside the door (incl. 6 hooks)

Product Info



Sizes (in cm)

Door opening:
125 x 137 cm (W x H)

Interior dimensions:
140 x 195 x 143 cm (L x W x H)

Storage capacity:
2 adult bicycles (please check the dimensions of your bicycles, see www.biohort.com for more information)

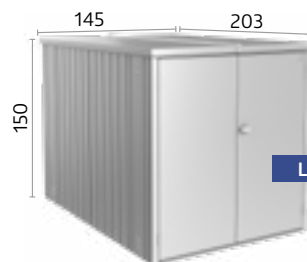

★ Optional Accessories



Bike Rail

The clamp panel is mounted on the back wall. The guide rail is hooked in at the desired height and allows for easy extraction and storage of bikes. Max. 2 bike rails possible. Max. Tyre width: 70 mm, max. bike length: 1.92 m;



Shelf Set

2 steel shelves (77 x 26.8 cm) and 2 support rails.



Electric Mounting Panel

Discreet, hidden cable routing and easy assembly of switches and outlets (electrical equipment in photo not included). Incl. 2 support rails.



Foundation Solutions

Aluminium Floor Frame/
Aluminium Floor Panels
SmartBase / SmartBase^{PLUS}

For details, see page 30 – 33.



StoreMax® Size 190, Metallic Silver

StoreMax®

Roller Shutter Up, Bicycle Out

Cuts Quite a Figure

Right in front of your home, immediately ready: the rainproof bicycle garage StoreMax® with the BikeHolder offers a maximum of storage without needing much space itself - perfect dimensions for up to 2 bicycles. The very smoothly working roller shutter helps you save your energy for the bicycle tour and protects your bicycle with a robust cylinder lock.



Metallic Silver



Metallic Quartz Grey



Metallic Dark Grey



The top shutter can be opened separately.



To fully open the StoreMax® the front shutter fully glides back.



Advantages

- Rainwater proof
- Shutter made from aluminium

Security:

- 2-way locking mechanism with T-handle cylinder lock

Functionality:

- Easy operation due to spring support

Standard Equipment:

- Tool holder on the inside of the side wall



Size (in cm)

Interior dimensions:
188 x 86 cm (W x H)

Storage capacity:
2 adult bicycles (please check the dimensions of your bicycles, see www.biohort.com for more information)

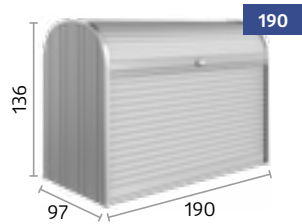

★ Optional Accessories



BikeHolder Set

The base plate including adjustable clamping levers can be hooked into 2 shelf support rails and provides optimal storage for 2 bicycles.



HighBoard Size 200, Metallic Quartz Grey
(with BikeHolder as accessory)

HighBoard

A Roomy Home for Your Bicycle

Store Your Valuables Safely

Cycling keeps you fit and the HighBoard keeps your bicycle running: absolutely rainwater proof, with integrated ventilation, special bicycle holders and a robust cylinder lock to protect it from theft. Up to two bicycles can be easily stowed and removed due to the lid which can be additionally opened. So nothing is standing in the way of a spontaneous cycling tour.



Metallic Silver



Metallic Quartz Grey

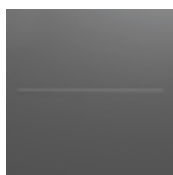

Metallic Dark Grey



Size 200, Metallic Silver with BikeHolder



Advantages

- Rainwater proof
- Invisible, integrated ventilation
- Screw and rivet free surfaces

Security:

- Locking mechanism with turn knob cylinder lock

Functionality:

- Comfortable lid opening with gas spring

Standard Equipment:

- Dustbin lid opener (3 pcs.)

Product Info



Size (in cm)

Door opening:

167 x 110 cm (W x H)

Interior dimensions:

195 x 76 x 120 cm (L x W x H)

Storage capacity:

2 adult bicycles (please check the dimensions of your bicycles, see www.biohort.com for more information)

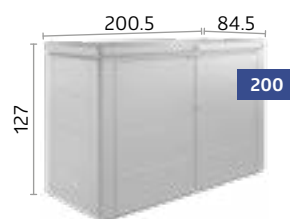

★ Optional Accessories



BikeHolder

The base plate including adjustable clamping levers can be hooked onto the inside of the side wall and provides optimal storage for 2 bicycles.



Electric Mounting Panel

Discreet, hidden cable routing and easy assembly of switches and outlets (electrical equipment in photo not included).



Tool Holder

For mounting on the inside of the doors. Max. 2 tool holders per door panel possible.



Lid Storage Net

The solution for small objects. It can be easily attached to the inside of the lid.



**THE MOST
APPEALING WAY
TO SEPARATE
WASTE**



58 Alex®



60 StoreMax®



62 HighBoard



Two Combined Dustbin Boxes Alex®, Metallic Quartz Grey

Alex®

Modular Dustbin Box

Modern Design, Clever Details

With the new Alex® dustbin system, any number of boxes can be arranged in a row, even at a later date, and thus separation systems can be optimally accommodated. The dustbin can be easily tipped out, the retaining bracket fixes it in the inclined position and facilitates filling. With its modern design, Alex® cuts a fine figure in every driveway!



Metallic Silver



Metallic Quartz Grey

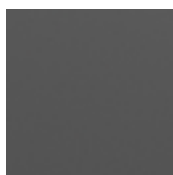

Metallic Dark Grey



Two Combined Dustbin Boxes Alex®, Metallic Quartz Grey

Function floor for wheel positioning



Advantages

- Can be expanded as required due to modular design
- Integrated ventilation
- Stable roof for planters
- Rainwater proof

Security:

- Locking mechanism with turn knob cylinder lock

Standard Equipment:

- Catch bar for tipping out the dustbin
- Function floor for wheel positioning
- Organiser system fitted inside the door (incl. 3 hooks)

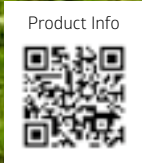

Size (in cm)

Door opening:

65 x 118 cm (W x H)
Available with left door hinge

Storage capacity:

120 L dustbin or
240 L dustbin

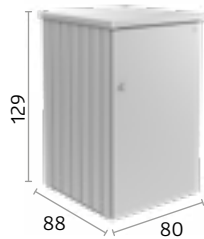

★ Optional Accessories

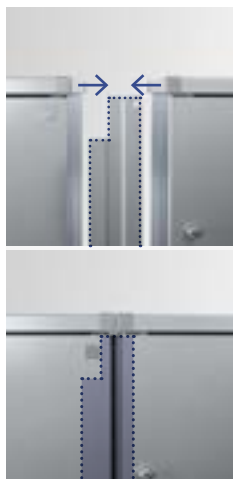

Connecting Element

The connecting element covers the gap between two dustbin boxes at the front and back.



Matching Cylinder Lock

If several boxes are used, access is possible with only one single key.



Shelves/Supports Rails (2 pcs.)

Galvanized steel shelves (72 x 24.5 cm) are suspended in the support rails.
Max. 4 shelves per dustbin box possible.



StoreMax® Size 160, Metallic Dark Grey

StoreMax®

Designer Cover for the Dustbins

Elegant Functionality

Up to three 240 L dustbins can be hidden behind the easily gliding roller shutters. The two-part opening system with its separately opening roller shutter allows for comfortable access to the hidden bins – and the easy removal of the dustbins when it is completely open.



Metallic Silver



Metallic Quartz Grey



Metallic Dark Grey



The top shutter can be opened separately.



To fully open the StoreMax® the front shutter fully glides back.



Advantages

- Rainwater proof
- Shutter made from aluminium

Security:

- 2-way locking mechanism with T-handle cylinder lock

Functionality:

- Easy operation due to spring support

Standard Equipment:

- Tool holder on the inside of the side wall



Sizes (in cm)

Storage capacity:

- Size 120: 2 x 120 L dustbins
- Size 160: 3 x 120 L dustbins or 2 x 240 L dustbins (transverse)
- Size 190: 3 x 120 L dustbins or 3 x 240 L dustbins

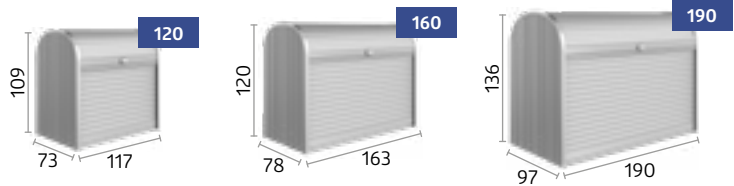

★ Optional Accessories



Corner Shelf Set (suitable for size 120 & 160)

2 shelves (triangular-shaped) with support rails, height adjustable in 5 different positions, easy to retrofit without any tools, can be fitted on the left or the right as required.





HighBoard Size 200, Metallic Silver

HighBoard

Something Nobel in the Front Garden

The Unsightly Beautifully Stowed

Dustbins are not easy on the eye – unless they are hidden in noble industrial design. Additionally, the HighBoard allows for easy filling and emptying of the bins with its spacious doors and the additional lid opening. The robust cylinder lock prevents others from using your dustbin.

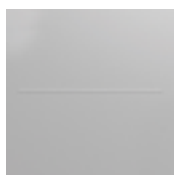

Metallic Silver

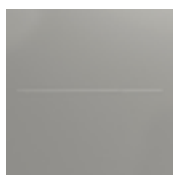

Metallic Quartz Grey

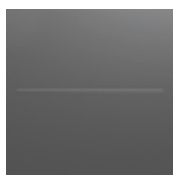

Metallic Dark Grey



Size 200, Metallic Quartz Grey



Advantages

- Rainwater proof
- Invisible, integrated ventilation
- Screw and rivet free surfaces

Security:

- Locking mechanism with turn knob cylinder lock

Functionality:

- Comfortable lid opening with gas spring

Standard Equipment:

- Dustbin lid opener (3 pcs.)



Sizes (in cm)

Door opening:

Size 160: 140 x 100 cm (W x H)

Size 200: 167 x 110 cm (W x H)

Storage capacity:

Size 160: 3 x 120 L dustbins

Size 200: 3 x 120 L dustbins or 3 x 240 L dustbins

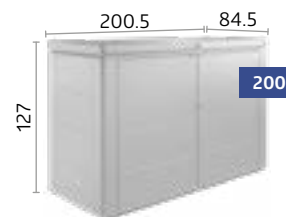
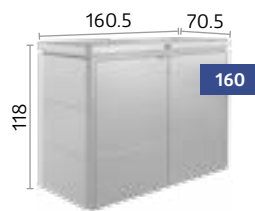

★ Optional Accessories



Tool Holder

For mounting on the inside of the doors.
Max. 2 tool holders per door panel possible.



THIS IS WHERE I
THRIVE



66 Raised Bed



68 Belvedere®



72 DaVinci®



Raised Bed 2 x 1, Metallic Silver

Raised Bed

Clever Cultivation

The Best Conditions for a Bountiful Harvest

Raised beds make cultivation easier and maximise the harvest - but only the Biohort raised bed perfects the most beautiful hobby in the world with intelligent design and practical functionality. Ingenious details add to the eye catching effect of this product, which offers more than just beauty!



Metallic Silver

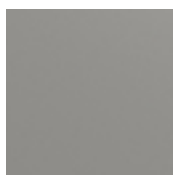

Metallic Quartz Grey



Metallic Dark Grey



Size 2x1, Metallic Dark Grey with cold frame extension in metallic quartz grey



Advantages

- Extremely durable
- Quickly assembled – only 8 screws
- Optimum working height
- Screw and rivet free surfaces

Security:

- Integrated rodent protection made of fibreglass fabric

Functionality:

- Snail guard, skirting, cold frame extension, trellis and intermediate floor are optionally available
- Sliding side walls make it easy to empty
- Opening for irrigation hose
- An ideal place to recycle garden cuttings

Product Info



Sizes (in cm)

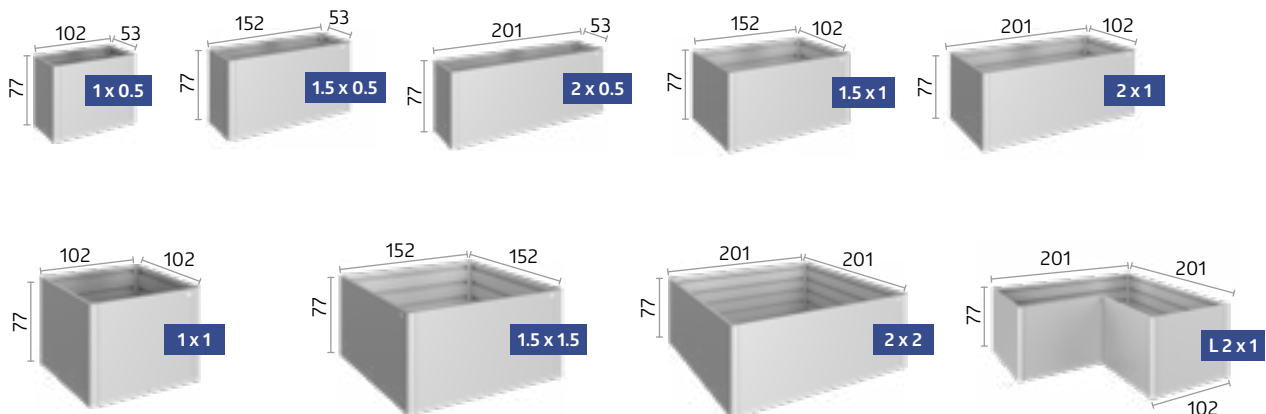

★ Optional accessories available on pages 70 – 71.



Belvedere® L150^{MAXI}, Metallic Quartz Grey

Belvedere®

Experiencing
Design

The Eye-Catcher for Your Terrace

With a width of only 50 cm, the planting bed Belvedere® creates a space for special ideas: as a living, plant filled room divider, it adds structure to your patio or garden and also embellishes your balcony. This product gives you completely new design possibilities.

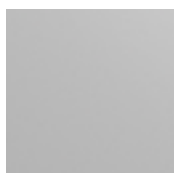

Metallic
Silver

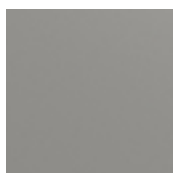

Metallic
Quartz Grey

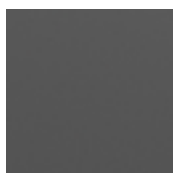

Metallic
Dark Grey



Size L100, Metallic Silver with Trellis



Advantages

- Extremely durable
- Quickly assembled
- Screw and rivet free surfaces

Security:

- Integrated rodent protection made of fibreglass fabric

Functionality:

- Skirting, trellis, privacy screen and planting insert optionally available
- Opening for irrigation hose

Standard Equipment:

- Intermediate floor

Product Info



Sizes (in cm)

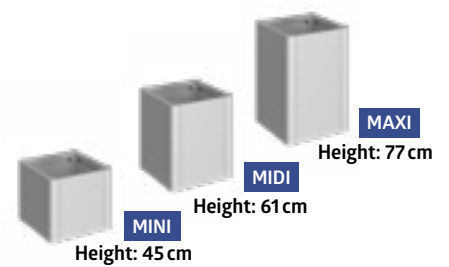
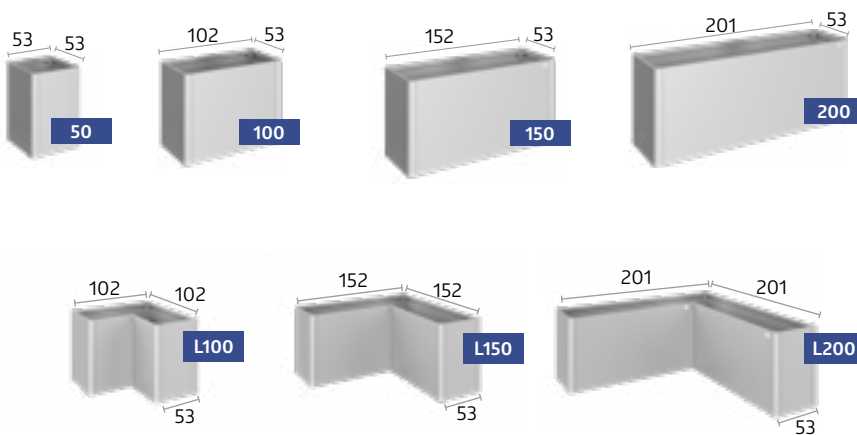



















Tip: All sizes are available in three different heights!

★ Optional accessories available on pages 70 – 71.

 **Standard Equipment**

 **Optional Accessories**

		Raised bed	Belvedere®
01	Sliding Panel* Easy to empty thanks to sliding panel.		
02	Preparation for Irrigation Opening for watering hose on the narrow side (size: 17 x 17 mm, except raised bed 2 x 2 and 1.5 x 1.5).		
03	Rodent Protection Integrated rodent protection made of fibreglass fabric. Is inserted before filling.		
04	Intermediate Floor* The intermediate floor reduces the volume of the bed and the soil filling required, saving both money and valuable time. It is placed on the second corrugation during assembly.		
05	Cold Frame Extension* Efficient frost protection with 4 easily removable sliding panels. Storm proof and equipped with rainwater drainage (suitable for size 2x1). Cannot be combined with Trellis (09).		
06	Snail Guard* It is placed on top of the raised bed. Can be combined with a cold frame extension (05). Not available for L sizes.		
07	Skirting* The skirting is mounted on the floor frame and placed on the lawn. The raised bed is then placed on the skirting and fastened (cannot be installed afterwards). Width: 6.7 cm		
08	Planter Insert Plastic insert (size: 0.5 x 0.5 m) for easier planting, is placed on the intermediate floor. Holes for drainage can be drilled without any problems.		
09	Trellis* The trellis is attached directly to the raised/planting bed. Cannot be combined with cold frame extension (05) or snail guard (06). Height: 91 cm		
10	Privacy Screen* with or without tinted glass panel In conjunction with the planting bed, the privacy screen forms a decorative boundary and serves not only as a privacy but also as a windscreen. Cannot be combined with cold frame extension (05) or snail guard (06). Height: 91 cm Note: In places exposed to wind, the product with privacy screen is at high risk of tipping over, therefore it is essential to ensure adequate ground anchorage - using the fastening materials supplied.		
11	Heights-Variants The three planter heights enable demand-oriented use. Height: 45 cm (Mini), 61 cm (Midi) and 77 cm (Maxi)		

*Made from galvanized, polyamide coated steel.



01 Sliding Panel



02 Preparation for Irrigation



03 Rodent Protection



04 Intermediate Floor



05 Cold Frame Extension



06 Snail Guard



07 Skirting



08 Planter Insert



09 Trellis



10 Privacy Screen with or without Tinted Glass Panel



11 Heights-Variants

Are you looking for an individual solution?

DaVinci®

Planter Box System





DaVinci®, Metallic Quartz Grey
Combination of different heights, lengths, with privacy screen and trellis

DaVinci®

Flexible Planter Box System

Limitless Individuality

Design the flexible planter box system DaVinci® freely according to your wishes. From planting bed with height graduations to privacy screen and terrace borders, there are no limits to the possibilities. The basic modules in different versions can be individually combined. With the help of the 3D-Configurator, your planter box system DaVinci® can be visualized with just a few clicks.



Metallic Silver

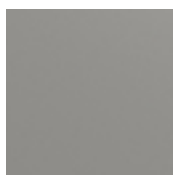

Metallic Quartz Grey



Metallic Dark Grey



DaVinci® as Flower Bed
Combination of different heights and lengths.



Advantages

- Individually configurable
- Extremely durable
- Available in different lengths, heights and combinations
- Screw and rivet free surfaces

Functionality:

- Privacy screen and trellis can be placed as desired
- Ideal as a terrace border

Standard Equipment:

- Intermediate floor



3 Heights, 4 Lengths, 3 Colours and Countless Possibilities

Possible heights from 45 cm to 77 cm and lengths from 50 cm to 200 cm.

Thanks to the modular construction, there are no limits to your wishes. The basic modules can be arranged in any order. Privacy screen and trellis can be positioned freely according to your expectations.

Configure your own Planter Box System DaVinci® now!
www.biohort.com/configurator

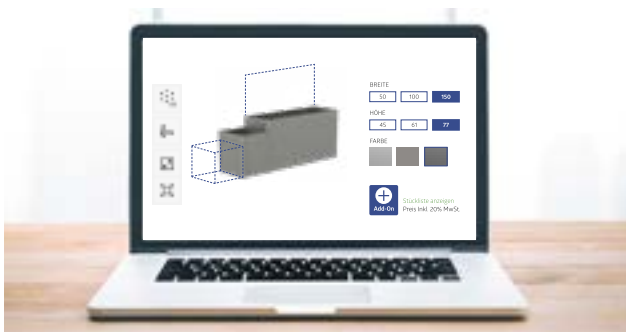

Configure your own Planter Box System DaVinci® now!
biohort.com/configurator or QR code above.

Flexible, Convenient and Versatile Configurations



DaVinci® as Privacy Screen
Combination of different heights, lengths and two privacy screens.



DaVinci® as Terrace Border
Combination of different heights, lengths and two trellises.



EVERYTHING
FOR THE
**OUTDOOR
OASIS**



76 Privacy Screen



78 MonAmi®



79 Charly®



80 WoodStock®



Privacy Screen with glass panel
Metallic Dark Grey

Privacy Screen

Decorative Eye-Catcher

A Piece of Privacy

Our privacy screen not only protects against curious eyes, it also offers protection from wind and direct sunlight. Thanks to the simple plug-in system, the elements can be individually expanded. Regardless of whether it is free-standing or directly on a house wall - the Biohort Privacy Screen is the perfect boundary for your garden oasis.

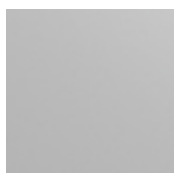

Metallic
Silver

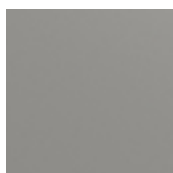

Metallic
Quartz Grey

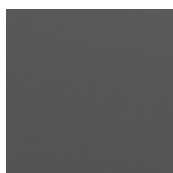

Metallic
Dark Grey

10 cm 180 cm 10 cm

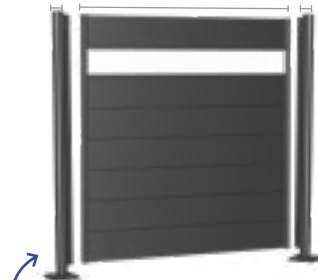

Privacy Screen consisting of:
Wall panels and posts

The posts can be used as end, corner or connecting post between two privacy screen panels.



Advantages

- Individually configurable
- Extremely durable
- Simple assembly
- Privacy, wind and sun screen
- Screw and rivet free surfaces

Security:

- High wind resistance due to well-thought-out ground anchoring

Functionality:

- Free-standing assembly or connection to house wall or similar possible
- Mounting accessories optionally available (see technical details)



Sizes (in cm)

Posts:

Height adjustable: up to 25 cm
Diameter: 10 cm

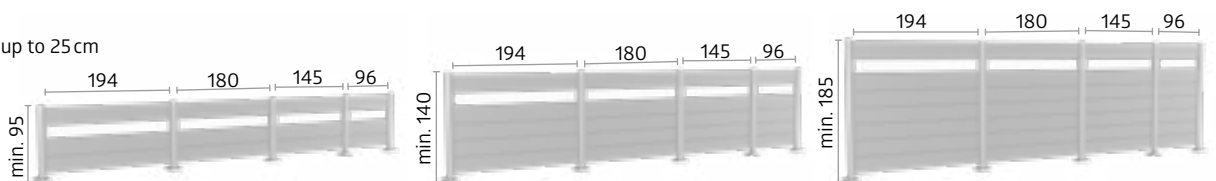

Optional Accessories

Components

Wall panels (with or without glass panels) and the appropriate posts are required for a privacy screen.



Privacy Screen Combinations

The privacy screen can be extended both in a straight line and in different 90° angles.

All widths and heights are compatible with each other, making height gradations also possible.



Variant 1: Post for anchoring, height-adjustable up to 25 cm

The base plate is bolted to a frost-proof concrete foundation using threaded rod anchors (optional available). Assembly on terrace tiles or wood/WPC boards is not sufficient.

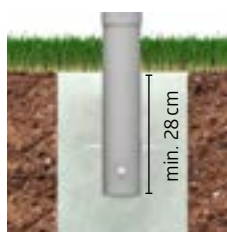

Variant 2: Post for setting in concrete, height-adjustable up to 25 cm

With this variant, the post is set directly into the concrete foundation.
Size of foundation points:
min. 50 x 50 cm (varies depending on soil conditions)
min. depth: 80 cm (varies depending on privacy screen height)

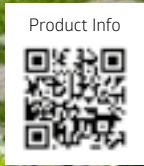

MonAmi®, Metallic Dark Grey

MonAmi® Composter

As "my friend" in the garden, the MonAmi® composter combines functionality with stylish appearance: elegant, smooth surfaces on the outside, inside everything required for efficient composting. Two centrally placed ventilation pipes create a chimney effect and ensure a reliable circulation of air, meanwhile the circumferential gap underneath the cover ensures that heat is transferred out of the composter. Even composting can now look great!

Advantages

- Extremely durable
- Screw and rivet free surfaces

Functionality:

- Integrated rodent protection made of fibreglass fabric

Standard Equipment:

- Ventilation system ensures an optimal rotting process
- Sliding front wall panel makes it convenient and easy to empty
- Comfortable lid with gas spring

Size (in cm)

Volume:

725 l

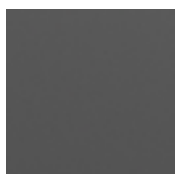
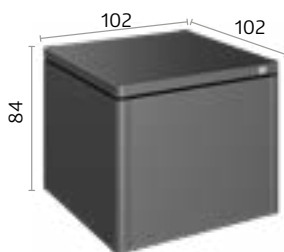

Metallic Dark Grey

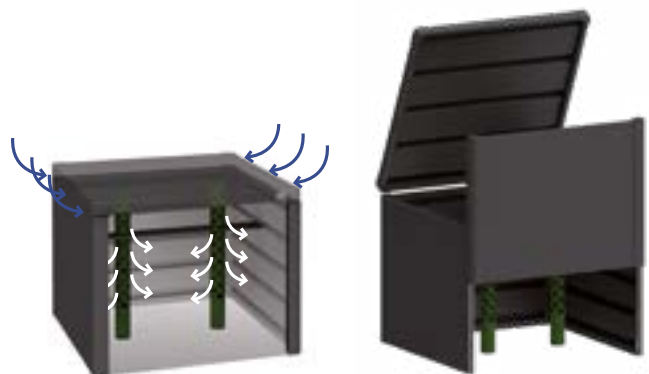

Ventilation Pipes

The integrated ventilation pipes provide an optimal supply of oxygen and circulation of air, which is essential for efficient composting.

Sliding Panel

Sliding front wall panel makes it convenient and easy to empty.



Charly® Size 2

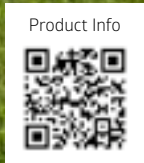

Charly®

Robotic Lawn Mower Garage

A shelter from the rain is not only the least that your hard-working robotic lawn mower deserves, but is also highly recommended for the protection of your robot! Suitable for all commercially available models, Robot Garage Charly® offers all the comfort that robots and owners need. The folding lid offers easy access to the control panel.

Advantages

Security:

- Folding-locking mechanism
- Corner protectors
- Ground screw fasteners

Functionality:

- Easy access to the control panel due to folding lid

Size (in cm)

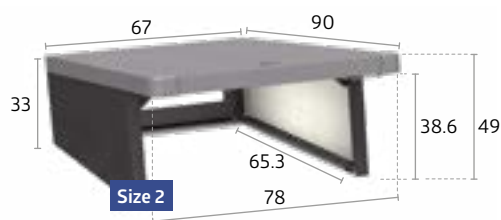

Folding-locking mechanism

The folding lid with its locking mechanism offers easy access to the control panel.

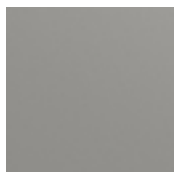

Lid:
Metallic
Quartz Grey

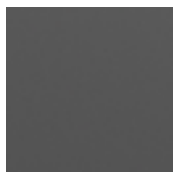

Side Walls:
Metallic
Dark Grey



WoodStock® Size 230, Metallic Dark Grey

WoodStock®

All-rounder

Firewood Storage and Equipment Locker in One

Nothing conjures up a cosier atmosphere than a blazing fire burning in the chimney on a cold winters day. But where to store the firewood? The WoodStock® provides the tidy and lasting solution for this question. During the summer it offers plenty of space for garden furniture and equipment. The possibility of attaching it to the house wall has proven to be particularly practical.



Metallic Silver



Metallic Quartz Grey



Metallic Dark Grey



WoodStock® Size 300, Metallic Quartz Grey



Advantages

- Stability because of massive aluminium frame

Security:

- Integrated gutter on the front side
- Universally applicable for garden tools
- Wide range of accessories available

Functionality:

- Screws and anchors for fixation to the ground



Sizes (in cm)

Volume:

Size 150: 2.1m³

Size 230: 3.1m³

Size 300: 4 m³

Possible to store wood in two rows
(max length of firewood: 35 cm)

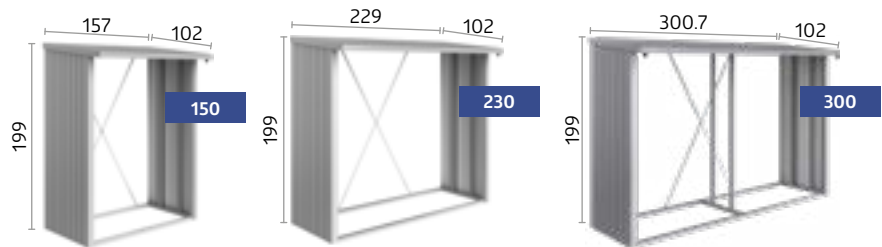

★ Optional Accessories



Aluminium Floor Panels

High quality aluminium chequer plate, protects the stored wood and gardening equipment from moisture.



Door Package

(suitable for size 150 & 230)

Double door fitted with T-handle cylinder lock and organiser system on the inside of the doors, Door opening: 135 x 171 cm (W x H).



Back Wall

Made from galvanized, polyamide coated steel.

Why Metal:

- + No Painting
- + The high-quality steel used by Biohort does not deform and remains in shape for decades.
- + The hot-dip galvanised, polyamide enamel coated steel used by Biohort is "fireproof" in accordance with EN 13501-1 (Class "A1").
- + Even premium German car manufacturers trust the same steel as we do.

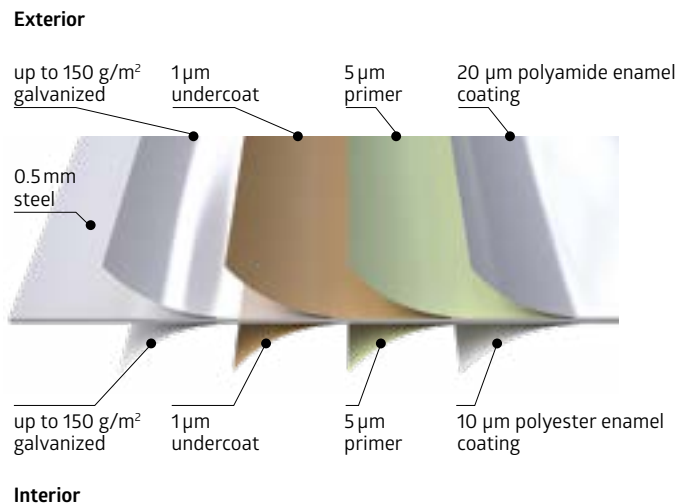

Did You Know?



Stability Test

A scientifically supervised test in the wind tunnel of the Vienna University of Technology certifies that Biohort garden sheds can withstand wind loads of up to 150 km/h (wind force 12) when properly assembled and anchored. Optimally designed profiles and the use of stainless steel screws further contribute to the durability of our products.



Material

Biohort uses a **hot-dip galvanised steel** with an additional **stove enamelling** with polyamide for its products. Biohort therefore provides a **20-year guarantee** against corrosion with a clear conscience. The prerequisite for this is that no aggressive substances (e.g. chlorine, salt, etc.) are stored and that there are no aggressive environmental conditions such as proximity to the sea or exposure to road salt.



Biohort Colours

The colour lacquers used are specially produced for us and do not correspond to any **RAL number**. Since many Biohort dealers have show models or original colour samples, we recommend visiting them before your purchase. Furthermore, you can request free material samples (colour sample sheets) on our website!

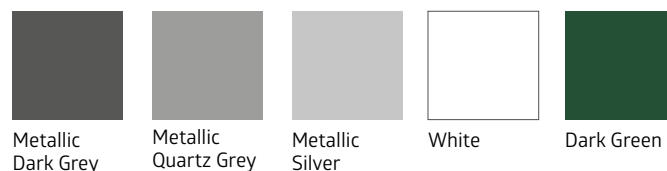

Sustainability is Our Claim

As an Austrian family business, we have been focusing on uncompromising sustainability for over 30 years. We are aware of our responsibility and always act according to the credo: **Today's actions have a decisive impact on tomorrow – economically, ecologically and socially!**

To Love the Environment

We focus on sustainable and environmentally friendly production. Biohort products have a very **long service life** and the processed steel plate is up to 100% recyclable. Short delivery and transport routes ensure low CO₂ emissions and our **packaging** is almost entirely made of recyclable material. Intra-company transport is carried out 100% by **electric vehicles**.

All our company buildings are equipped with **photovoltaic systems**. With the solar power we produce ourselves, we cover one third of the annual electricity requirements of our production. We currently cover 10 % of the heating energy requirements of our company buildings with **heat pumps** and in future an additional 50 % with **biomass heating** from our residual wood. In total, almost half of our total energy requirements can be met from our own, sustainable sources.



Steel is 100 %
Recyclable



Local Suppliers







Production in
Austria





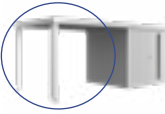
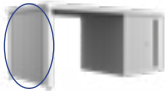

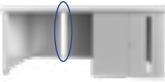
Sustainable
Energy Sources



Garden Shed Neo

Neo	Size	Exterior Dimensions*	Interior Dimensions	Foundation Dimensions	Weight (kg)	EAN Code		
		W x L x H (cm)	W x L x H (cm)	W x L (cm)		Metallic Silver	Metallic Quartz Grey	Metallic Dark Grey
With standard door, door opening: 83 x 200 cm (W x H), right door hinge								
	1A	180 x 180 x 222	164 x 164 x 208	173 x 173	211.5	9003414 81003 7	9003414 87003 1	9003414 85003 3
	2A	180 x 236 x 222	164 x 220 x 208	173 x 229	243.7	9003414 81006 8	9003414 87006 2	9003414 85006 4
	3A	180 x 292 x 222	164 x 276 x 208	173 x 285	304.4	9003414 81009 9	9003414 87009 3	9003414 85009 5
	4A	180 x 348 x 222	164 x 332 x 208	173 x 341	335.8	9003414 81014 3	9003414 87014 7	9003414 85014 9
	1B	236 x 180 x 222	220 x 164 x 208	229 x 173	245.9	9003414 81029 7	9003414 87029 1	9003414 85029 3
	2B	236 x 236 x 222	220 x 220 x 208	229 x 229	284.7	9003414 81034 1	9003414 87034 5	9003414 85034 7
	3B	236 x 292 x 222	220 x 276 x 208	229 x 285	349.2	9003414 81040 2	9003414 87040 6	9003414 85040 8
	4B	236 x 348 x 222	220 x 332 x 208	229 x 341	392.9	9003414 81044 0	9003414 87044 4	9003414 85044 6
	1C	292 x 180 x 222	276 x 164 x 208	285 x 173	311.9	9003414 81082 2	9003414 87082 6	9003414 85082 8
	2C	292 x 236 x 222	276 x 220 x 208	285 x 229	348.7	9003414 81085 3	9003414 87085 7	9003414 85085 9
	3C	292 x 292 x 222	276 x 276 x 208	285 x 285	433.9	9003414 81089 1	9003414 87089 5	9003414 85089 7
	4C	292 x 348 x 222	276 x 332 x 208	285 x 341	474.7	9003414 81092 1	9003414 87092 5	9003414 85092 7
	1D	348 x 180 x 222	332 x 164 x 208	341 x 173	340.1	9003414 82024 1	9003414 89024 4	9003414 86024 7
	2D	348 x 236 x 222	332 x 220 x 208	341 x 229	383.5	9003414 82028 9	9003414 89028 2	9003414 86028 5
	3D	348 x 292 x 222	332 x 276 x 208	341 x 285	421.2	9003414 82031 9	9003414 89031 2	9003414 86031 5
	4D	348 x 348 x 222	332 x 332 x 208	341 x 341	515	9003414 82034 0	9003414 89034 3	9003414 86034 6
With double door, door opening: 167 x 200 cm (W x H)								
	1B	236 x 180 x 222	220 x 164 x 208	229 x 173	257.6	9003414 81060 0	9003414 87060 4	9003414 85060 6
	2B	236 x 236 x 222	220 x 220 x 208	229 x 229	296.7	9003414 81063 1	9003414 87063 5	9003414 85063 7
	3B	236 x 292 x 222	220 x 276 x 208	229 x 285	361	9003414 81069 3	9003414 87069 7	9003414 85069 9
	4B	236 x 348 x 222	220 x 332 x 208	229 x 341	400	9003414 81072 3	9003414 87072 7	9003414 85072 9
	1C	292 x 180 x 222	276 x 164 x 208	285 x 173	323.9	9003414 82005 0	9003414 89005 3	9003414 86005 6
	2C	292 x 236 x 222	276 x 220 x 208	285 x 229	360.4	9003414 82008 1	9003414 89008 4	9003414 86008 7
	3C	292 x 292 x 222	276 x 276 x 208	285 x 285	441	9003414 82011 1	9003414 89011 4	9003414 86011 7
	4C	292 x 348 x 222	276 x 332 x 208	285 x 341	485.5	9003414 82014 2	9003414 89014 5	9003414 86014 8
	1D	348 x 180 x 222	332 x 164 x 208	341 x 173	351.9	9003414 82044 9	9003414 89044 2	9003414 86044 5
	2D	348 x 236 x 222	332 x 220 x 208	341 x 229	390.5	9003414 82048 7	9003414 89048 0	9003414 86048 3
	3D	348 x 292 x 222	332 x 276 x 208	341 x 285	479.3	9003414 82051 7	9003414 89051 0	9003414 86051 3
	4D	348 x 348 x 222	332 x 332 x 208	341 x 341	526.7	9003414 82054 8	9003414 89054 1	9003414 86054 4
Additions								
Side Canopy for Garden Shed Neo								
	2A-2D	300 x 235 x 220			226.8	9003414 81026 6	9003414 87026 0	9003414 85026 2
	3A-3D	300 x 291 x 220			287.3	9003414 81036 5	9003414 87036 9	9003414 85036 1
	4A-4D	300 x 347 x 220			319.3	9003414 81046 4	9003414 87046 8	9003414 85046 0
Side Wall for Side Canopy								
	2A-2D	203 x 4.3 x 200			65.5	9003414 81028 0	9003414 87028 4	9003414 85028 6
	3A-3D	259 x 4.3 x 200			72.2	9003414 81038 9	9003414 87038 3	9003414 85038 5
	4A-4D	315 x 4.3 x 200			89.7	9003414 81048 8	9003414 87048 2	9003414 85048 4
Back Wall for Side Canopy								
	2A-4D	299 x 4.3 x 200			88.6	9003414 81098 3	9003414 87098 7	9003414 85098 9
Tinted Glass Panel for Side Canopy								
	2A-4D	31.8 x 4.2 x 200			7	9003414 47934 0	9003414 47984 5	9003414 47954 8
FloraBoard for Side Canopy								
	2A-4D	84 x 24 x 197			11.9	9003414 47036 1	9003414 47086 6	9003414 47056 9

*highest point, incl. roof overhang

Foundation Accessories / Foundation suitable for	EAN Code Aluminium Floor Frame	EAN Code Aluminium Floor Panels	EAN Code SmartBase	EAN Code SmartBase ^{PLUS}
Neo				
1A	9003414 41014 5	9003414 48014 8	9003414 43950 4	9003414 43450 9
1B, 2A	9003414 41024 4	9003414 48024 7	9003414 43954 2	9003414 43454 7
1C, 3A	9003414 41034 3	9003414 48034 6	9003414 43955 9	9003414 43455 4
1D, 4A	9003414 41044 2	9003414 48044 5	9003414 43956 6	9003414 43456 1
2B	9003414 41040 4	9003414 48040 7	9003414 43918 4	9003414 43418 9
2C, 3B	9003414 41054 1	9003414 48054 4	9003414 43960 3	9003414 43460 8
2D, 4B	9003414 41067 1	9003414 48064 3	9003414 43962 7	9003414 43462 2
3C	9003414 41074 9	9003414 48074 2	9003414 43965 8	9003414 43465 3
3D, 4C	9003414 41084 8	9003414 48084 1	9003414 43970 2	9003414 43470 7
4D	9003414 41094 7	9003414 48094 0	9003414 43974 0	9003414 43474 5

Note: Hammer drills can be rented from any well-equipped specialist, however the drill bit required is available from Biohort.

Drill Bit Ø 40 x 570 mm for SDS-MAX chuck Ø 18 mm (for SmartBase^{PLUS})

9003414 **43410** 3

Note: In combination with an additional door, an additional package is required for the SmartBase and SmartBase^{PLUS}.

Foundation Additional Package

9003414 **43505** 6

9003414 **43405** 9

Note: If the floor frame is laid directly on a gravel base (approx. 10 cm gravel, without foundation or slabs), ground anchors are required for securing to the ground. Storm resistance must be ensured by the customer. For size 1A, 1B, 2A, 2B: 8 pcs. in total; for size 1C, 3A, 1D, 4A: 10 pcs. in total; for size 2C, 3B, 2D, 4B: 14 pcs. in total; for size 3C, 3D, 4C, 4D: 16 pcs. in total are necessary.

Ground Anchor	4 pieces per package	9003414 41004 6
	6 pieces per package	9003414 41006 0

Interior Fittings suitable for		EAN Code	EAN Code
Standard Door	Double Door	Interior Panelling	Insulation
1A		9003414 46051 5	9003414 46081 2
1B, 2A		9003414 46052 2	9003414 46082 9
	1B	9003414 46053 9	9003414 46081 2
1C, 3A		9003414 46056 0	9003414 46084 3
	1C	9003414 46057 7	9003414 46082 9
1D, 4A		9003414 46058 4	9003414 46086 7
	1D	9003414 46061 4	9003414 46084 3
2B		9003414 46054 6	9003414 46084 3
	2B	9003414 46055 3	9003414 46082 9
2C, 3B		9003414 46059 1	9003414 46086 7
	2C, 3B	9003414 46060 7	9003414 46084 3
2D, 4B		9003414 46062 1	9003414 46088 1
	2D, 4B	9003414 46064 5	9003414 46086 7
3C		9003414 46063 8	9003414 46088 1
	3C	9003414 46065 2	9003414 46086 7
3D, 4C		9003414 46066 9	9003414 46090 4
	3D, 4C	9003414 46067 6	9003414 46088 1
4D		9003414 46068 3	9003414 46093 5
	4D	9003414 46069 0	9003414 46090 4

Accessories		Dimensions W x L x H (cm)	EAN Code		
Accessories in matching colour			Metallic Silver	Metallic Quartz Grey	Metallic Dark Grey
Glass Panel	tinted	32 x 3.3 x 207	9003414 47034 7	9003414 47084 2	9003414 47054 5
Additional Door		83 x 3 x 203	9003414 81002 0	9003414 87002 4	9003414 85002 6
Tool Holder	2 pieces per package	30 x 5 x 3.5	9003414 47032 3	9003414 47082 8	9003414 47052 1
FloraBoard		84 x 24 x 205	9003414 47035 4	9003414 47085 9	9003414 47055 2

Accessories		Dimensions W x L x H (cm)	EAN Code
Accessories made of galvanised steel, grey white coated			
Shelves	2 pieces per package	56 x 26 x 17.3	9003414 45040 0
	4 pieces per package	56 x 26 x 17.3	9003414 45050 9
	2 pieces per package	56 x 44.5 x 17.3	9003414 45060 8
Suspension Basket	With wall bracket	56 x 34 x 20	9003414 47073 6
Hook Set	One combi handle and shovel hook each	56 x 23 x 10	9003414 47072 9
Tool Hangers	2 pieces per package	28 x 10.4 x 17.2	9003414 47021 7
Door Baskets	2 pieces per package	34 x 10 x 9.5	9003414 46025 6
Shelf Baskets	2 pieces per package	72 x 16 x 11	9003414 46026 3
Threshold Access Ramp	Only with double door and floor frame	170.5 x 9.1 x 3	9003414 41001 5
BikeLift®	Standard	33 x 184 x 28	9003414 49052 9
	Swivel Mount	33 x 184 x 39	9003414 49053 6
Bicycle Hanger BikeMax	1 piece per package	14.5 x 8 x 205.5	9003414 49030 7
BikeHolder	set for 2 bikes	56 x 17.7 x 33	9003414 49032 1
Electric Mounting Panel		28 x 4 x 204	9003414 46034 8
LED Light		44 x 4 x 1.5	9003414 46041 6

Outbuilding CasaNova®



Available in **two colours and nine sizes**.

The complete range, the accessories and technical details can be found in the CasaNova® brochure or at www.biohort.com/casanova.

CasaNova®
Brochure
request via
www.biohort.com

Garden Shed HighLine®, Panorama®, AvantGarde® and AvantGarde® ECO





HighLine®	Size	Exterior Dimensions*	Interior Dimensions	Foundation Dimensions	Weight	EAN Code		
		W x L x H (cm)	W x L x H (cm)	W x L (cm)	(kg)	Metallic Silver	Metallic Quartz Grey	Metallic Dark Grey
With standard door, door opening: 76 x 182 cm (W x H), right door hinge								
	H5	155 x 275 x 222	132 x 252 x 210	137 x 257	222.8	9003414 83010 3	9003414 88010 8	9003414 84010 2
	H1	275 x 155 x 222	252 x 132 x 210	257 x 137	214.5	9003414 83020 2	9003414 88020 7	9003414 84020 1
	H2	275 x 195 x 222	252 x 172 x 210	257 x 177	232	9003414 83030 1	9003414 88030 6	9003414 84030 0
	H3	275 x 235 x 222	252 x 212 x 210	257 x 217	267.5	9003414 83040 0	9003414 88040 5	9003414 84040 9
	H4	275 x 275 x 222	252 x 252 x 210	257 x 257	283.6	9003414 83050 9	9003414 88050 4	9003414 84050 8
	H5	275 x 315 x 222	252 x 292 x 210	257 x 297	317.8	9003414 83060 8	9003414 88060 3	9003414 84060 7
	H6	315 x 315 x 222	292 x 292 x 210	297 x 297	377	9003414 83070 7	9003414 88070 6	9003414 84070 2
With double door, door opening: 155 x 182 cm (W x H)								
	H1	275 x 155 x 222	252 x 132 x 210	257 x 137	226.9	9003414 83029 5	9003414 88029 0	9003414 84029 4
	H2	275 x 195 x 222	252 x 172 x 210	257 x 177	244.4	9003414 83039 4	9003414 88039 9	9003414 84039 3
	H3	275 x 235 x 222	252 x 212 x 210	257 x 217	279.9	9003414 83049 3	9003414 88049 8	9003414 84049 2
	H4	275 x 275 x 222	252 x 252 x 210	257 x 257	296	9003414 83059 2	9003414 88059 7	9003414 84059 1
	H5	275 x 315 x 222	252 x 292 x 210	257 x 297	330.2	9003414 83069 1	9003414 88069 6	9003414 84069 0
	H6	315 x 315 x 222	292 x 292 x 210	297 x 297	389.4	9003414 83079 0	9003414 88079 9	9003414 84079 5
Additions								
Side canopy size S for garden shed HighLine®, width: 150 cm								
	H2	150 x 195 x 222			75.8	9003414 83836 9	9003414 88836 4	9003414 84836 8
	H3	150 x 235 x 222			86.7	9003414 83846 8	9003414 88846 3	9003414 84846 7
	H4	150 x 275 x 222			94.2	9003414 83856 7	9003414 88856 2	9003414 84856 6
	H5, H6	150 x 315 x 222			104.1	9003414 83866 6	9003414 88866 1	9003414 84866 5
Side canopy size L for garden shed HighLine®, width: 282 cm								
	H2	282 x 195 x 222			115	9003414 83036 3	9003414 88036 8	9003414 84036 2
	H3	282 x 235 x 222			134.6	9003414 83046 2	9003414 88046 7	9003414 84046 1
	H4	282 x 275 x 222			141.3	9003414 83056 1	9003414 88056 6	9003414 84056 0
	H5, H6	282 x 315 x 222			155.8	9003414 83066 0	9003414 88066 5	9003414 84066 9
Side wall for side canopy size S and size L								
	H2	157 x 2.5 x 181			37.8	9003414 83038 7	9003414 88038 2	9003414 84038 6
	H3	197 x 2.5 x 181			45.6	9003414 83048 6	9003414 88048 1	9003414 84048 5
	H4	237 x 2.5 x 181			54.8	9003414 83058 5	9003414 88058 0	9003414 84058 4
	H5, H6	277 x 2.5 x 181			62.8	9003414 83068 4	9003414 88068 9	9003414 84068 3
Back wall for side canopy size S, width: 150 cm								
	S	134 x 4 x 181			33.8	9003414 83097 4	9003414 88097 9	9003414 84097 3
Back wall for side canopy size L, width: 282 cm								
	L	266 x 4 x 181			61.2	9003414 83098 1	9003414 88098 6	9003414 84098 0
Panorama®								
With standard door, door opening: 76 x 182 cm (W x H), right door hinge								
	P1	273 x 158 x 227	252 x 132 x 220	257 x 137	202.2	9003414 13020 3	9003414 18020 8	9003414 14020 2
	P2	273 x 198 x 227	252 x 172 x 220	257 x 177	225.7	9003414 13030 2	9003414 18030 7	9003414 14030 1
	P3	273 x 238 x 227	252 x 212 x 220	257 x 217	250	9003414 13040 1	9003414 18040 6	9003414 14040 0
	P4	273 x 278 x 227	252 x 252 x 220	257 x 257	271.9	9003414 13050 0	9003414 18050 5	9003414 14050 9
	P5	273 x 318 x 227	252 x 292 x 220	257 x 297	293.9	9003414 13060 9	9003414 18060 4	9003414 14060 8
With double door, door opening: 155 x 182 cm (W x H)								
	P1	273 x 158 x 227	252 x 132 x 220	257 x 137	214.6	9003414 13029 6	9003414 18029 1	9003414 14029 5
	P2	273 x 198 x 227	252 x 172 x 220	257 x 177	238.1	9003414 13039 5	9003414 18039 0	9003414 14039 4
	P3	273 x 238 x 227	252 x 212 x 220	257 x 217	262.4	9003414 13049 4	9003414 18049 9	9003414 14049 3
	P4	273 x 278 x 227	252 x 252 x 220	257 x 257	284.3	9003414 13059 3	9003414 18059 8	9003414 14059 2
	P5	273 x 318 x 227	252 x 292 x 220	257 x 297	306.3	9003414 13069 2	9003414 18069 7	9003414 14069 1





*highest point, incl. roof overhang

AvantGarde®	Size	Exterior Dimensions*	Interior Dimensions	Foundation Dimensions	Weight	EAN Code		
		W x L x H (cm)	W x L x H (cm)	W x L (cm)	(kg)	Metallic Silver	Metallic Quartz Grey	Metallic Dark Grey
With standard door, door opening: 76 x 182 cm (W x H), right door hinge								
	A1	180 x 220 x 218	172 x 172 x 209	177 x 177	155.8	9003414 15010 2	9003414 19010 8	9003414 17010 0
	A2	180 x 260 x 218	172 x 212 x 209	177 x 217	175.7	9003414 15020 1	9003414 19020 7	9003414 17020 9
	A3	180 x 300 x 218	172 x 252 x 209	177 x 257	194.2	9003414 15030 0	9003414 19030 6	9003414 17030 8
	A4	180 x 380 x 222	172 x 332 x 209	177 x 337	237.3	9003414 15040 9	9003414 19040 5	9003414 17040 7
	A5	260 x 220 x 218	252 x 172 x 209	257 x 177	191	9003414 15050 8	9003414 19050 4	9003414 17050 6
	A6	260 x 260 x 218	252 x 212 x 209	257 x 217	214.5	9003414 15060 7	9003414 19060 3	9003414 17060 5
	A7	260 x 300 x 218	252 x 252 x 209	257 x 257	230.8	9003414 15070 6	9003414 19070 2	9003414 17070 4
	A8	260 x 380 x 222	252 x 332 x 209	257 x 337	281.5	9003414 15080 5	9003414 19080 1	9003414 17080 3
With double door, door opening: A1 - A4: 139 x 182 cm (W x H), A5 - A8: 155 x 182 cm (W x H)								
	A1	180 x 220 x 218	172 x 172 x 209	177 x 177	167	9003414 15019 5	9003414 19019 1	9003414 17019 3
	A2	180 x 260 x 218	172 x 212 x 209	177 x 217	186.9	9003414 15029 4	9003414 19029 0	9003414 17029 2
	A3	180 x 300 x 218	172 x 252 x 209	177 x 257	202.4	9003414 15039 3	9003414 19039 9	9003414 17039 1
	A4	180 x 380 x 222	172 x 332 x 209	177 x 337	247	9003414 15049 2	9003414 19049 8	9003414 17049 0
	A5	260 x 220 x 218	252 x 172 x 209	257 x 177	203.4	9003414 15059 1	9003414 19059 7	9003414 17059 9
	A6	260 x 260 x 218	252 x 212 x 209	257 x 217	226.9	9003414 15069 0	9003414 19069 6	9003414 17069 8
	A7	260 x 300 x 218	252 x 252 x 209	257 x 257	243.2	9003414 15079 9	9003414 19079 5	9003414 17079 7
	A8	260 x 380 x 222	252 x 332 x 209	257 x 337	293.9	9003414 15089 8	9003414 19089 4	9003414 17089 6



AvantGarde®ECO	Size	Exterior Dimensions*	Interior Dimensions	Foundation Dimensions	Weight	EAN Code		
		W x L x H (cm)	W x L x H (cm)	W x L (cm)	(kg)	Metallic Silver	Metallic Quartz Grey	Metallic Dark Grey
With standard door, door opening: 76 x 182 cm (W x H), right door hinge								
	A1	180 x 220 x 218	172 x 172 x 209	177 x 177	128	9003414 15610 4	9003414 19610 0	9003414 17610 2
	A2	180 x 260 x 218	172 x 212 x 209	177 x 217	146	9003414 15620 3	9003414 19620 9	9003414 17620 1
	A3	180 x 300 x 218	172 x 252 x 209	177 x 257	161	9003414 15630 2	9003414 19630 8	9003414 17630 0
	A4	180 x 380 x 222	172 x 332 x 209	177 x 337	204	9003414 15640 1	9003414 19640 7	9003414 17640 9
	A5	260 x 220 x 218	252 x 172 x 209	257 x 177	160	9003414 15650 0	9003414 19650 6	9003414 17650 8
	A6	260 x 260 x 218	252 x 212 x 209	257 x 217	182	9003414 15660 9	9003414 19660 5	9003414 17660 7
	A7	260 x 300 x 218	252 x 252 x 209	257 x 257	194	9003414 15670 8	9003414 19670 4	9003414 17670 6
	A8	260 x 380 x 222	252 x 332 x 209	257 x 337	246	9003414 15680 7	9003414 19680 3	9003414 17680 5
With double door, door opening: A1 - A4: 139 x 182 cm (W x H), A5 - A8: 155 x 182 cm (W x H)								
	A1	180 x 220 x 218	172 x 172 x 209	177 x 177	133	9003414 15619 7	9003414 19619 3	9003414 17619 5
	A2	180 x 260 x 218	172 x 212 x 209	177 x 217	151	9003414 15629 6	9003414 19629 2	9003414 17629 4
	A3	180 x 300 x 218	172 x 252 x 209	177 x 257	166	9003414 15639 5	9003414 19639 1	9003414 17639 3
	A4	180 x 380 x 222	172 x 332 x 209	177 x 337	215	9003414 15649 4	9003414 19649 0	9003414 17649 2
	A5	260 x 220 x 218	252 x 172 x 209	257 x 177	163	9003414 15659 3	9003414 19659 9	9003414 17659 1
	A6	260 x 260 x 218	252 x 212 x 209	257 x 217	185	9003414 15669 2	9003414 19669 8	9003414 17669 0
	A7	260 x 300 x 218	252 x 252 x 209	257 x 257	197	9003414 15679 1	9003414 19679 7	9003414 17679 9
	A8	260 x 380 x 222	252 x 332 x 209	257 x 337	249	9003414 15689 0	9003414 19689 6	9003414 17689 8

*highest point, incl. roof overhang

Foundation Accessories / Foundation			EAN Code	EAN Code	EAN Code	EAN Code
suitable for			Aluminium Floor Frame	Aluminium Floor Panels	SmartBase	SmartBase ^{PLUS}
HighLine®	Panorama®	AvantGarde® AvantGarde®ECO				
		A1	9003414 41031 2	9003414 48031 5	9003414 43946 7	9003414 43446 2
		A2	9003414 41071 8	9003414 48071 1	9003414 43988 7	9003414 43488 2
H1, HS	P1		9003414 41022 0	9003414 48022 3	9003414 43952 8	9003414 43452 3
H2	P2	A3, A5	9003414 41041 1	9003414 48041 4	9003414 43958 0	9003414 43458 5
		A4	9003414 41081 7	9003414 48081 0	9003414 43976 4	9003414 43476 9
H3	P3	A6	9003414 41042 8	9003414 48042 1	9003414 43963 4	9003414 43463 9
H4	P4	A7	9003414 41051 0	9003414 48051 3	9003414 43968 9	9003414 43468 4
H5	P5		9003414 41062 6	9003414 48062 9	9003414 43973 3	9003414 43473 8
		A8	9003414 41061 9	9003414 48061 2	9003414 43978 8	9003414 43478 3
H6			9003414 41043 5	9003414 48043 8	9003414 43995 5	9003414 43495 0
Note: Hammer drills can be rented from any well-equipped specialist, however the drill bit required is available from Biohort.						
Drill Bit Ø 40 x 570 mm for SDS-MAX chuck Ø 18 mm (for SmartBase ^{PLUS})						9003414 43410 3
Note: In combination with an additional door, an additional package is required for the SmartBase and SmartBase ^{PLUS} .						
Foundation Additional Package					9003414 43505 6	9003414 43405 9
Note: If the floor frame is laid directly on a gravel base (approx. 10 cm gravel, without foundation or slabs), ground anchors are required for securing to the ground. Storm resistance must be ensured by the customer. For size A1, HS, H1, P1: 8 pcs. in total; for size H2, P2, A2, H3, P3, A3, A4, A5, A6: 10 pcs. in total; for size H4, P4, H5, P5, H6 A7, A8: 12 pcs. in total are necessary.						
Ground Anchor		4 pieces per package	9003414 41004 6			
		6 pieces per package	9003414 41006 0			

Accessories		Dimensions W x L x H (cm) / Colour				
Accessories in matching colour			HighLine®	Panorama®	AvantGarde®	AvantGarde®ECO
Additional Door	With stainless steel door handle and gas spring	Metallic Silver	9003414 83002 8	9003414 83002 8	9003414 83002 8	-
		Metallic Quartz Grey	9003414 88002 3	9003414 88002 3	9003414 88002 3	-
		Metallic Dark Grey	9003414 84002 7	9003414 84002 7	9003414 84002 7	-
Additional Door ECO	Corrugated, with T-handle cylinder lock and door hooks	Metallic Silver	-	-	-	9003414 83602 0
		Metallic Quartz Grey	-	-	-	9003414 88602 5
		Metallic Dark Grey	-	-	-	9003414 84602 9
Window Unit		Metallic Silver	9003414 43065 5	9003414 43065 5	9003414 43065 5	9003414 43065 5
		Metallic Quartz Grey	9003414 43085 3	9003414 43085 3	9003414 43085 3	9003414 43085 3
		Metallic Dark Grey	9003414 43055 6	9003414 43055 6	9003414 43055 6	9003414 43055 6
Rainwater Downpipe Set		Metallic Silver	9003414 44025 8	9003414 44024 1	9003414 44022 7	9003414 44022 7
		Metallic Quartz Grey	9003414 44085 2	9003414 44084 5	9003414 44082 1	9003414 44082 1
		Metallic Dark Grey	9003414 44065 4	9003414 44064 7	9003414 44062 3	9003414 44062 3
FloraBoard		Metallic Silver	9003414 47030 9	9003414 47030 9	9003414 47030 9	9003414 47030 9
		Metallic Quartz Grey	9003414 47080 4	9003414 47080 4	9003414 47080 4	9003414 47080 4
		Metallic Dark Grey	9003414 47050 7	9003414 47050 7	9003414 47050 7	9003414 47050 7
Tool Holder	2 pieces per package	Metallic Silver	9003414 47031 6	9003414 47031 6	9003414 47031 6	-
		Metallic Quartz Grey	9003414 47081 1	9003414 47081 1	9003414 47081 1	-
		Metallic Dark Grey	9003414 47051 4	9003414 47051 4	9003414 47051 4	-
Tool Holder ECO	2 pieces per package for ECO doors	Metallic Silver	-	-	-	9003414 47032 3
		Metallic Quartz Grey	-	-	-	9003414 47082 8
		Metallic Dark Grey	-	-	-	9003414 47052 1
Made from hot-dip galvanised, polyamide coated steel plate.						
Shelf Support Rails	2 pieces per package	4 x 4 x 185	9003414 46021 8	9003414 46021 8	9003414 46021 8	9003414 46021 8
Shelves	2 pieces per package	72 x 24.5 x 7	9003414 45010 3	9003414 45010 3	9003414 45010 3	9003414 45010 3
	4 pieces per package	72 x 24.5 x 7	9003414 45020 2	9003414 45020 2	9003414 45020 2	9003414 45020 2
	2 pieces per package	72 x 43.5 x 7	9003414 45030 1	9003414 45030 1	9003414 45030 1	9003414 45030 1
Folding Table		69.2 x 57.5 x 40	9003414 40011 5	9003414 40011 5	9003414 40011 5	9003414 40011 5
Suspension Basket	With wall bracket	67 x 34 x 20	9003414 47071 2	9003414 47071 2	9003414 47071 2	9003414 47071 2
Hook Set	One combi, handle and shovel hook each	72 x 17 x 73	9003414 47070 5	9003414 47070 5	9003414 47070 5	9003414 47070 5
Tool Hangers	4 pieces per package	13 x 9.5 x 30	9003414 47020 0	9003414 47020 0	9003414 47020 0	9003414 47020 0
Door Baskets	2 pieces per package	34 x 10 x 9.5	9003414 46025 6	9003414 46025 6	9003414 46025 6	9003414 46025 6
Shelf Baskets	2 pieces per package	72 x 16 x 11	9003414 46026 3	9003414 46026 3	9003414 46026 3	9003414 46026 3
Threshold Access Ramp	Only with double door and floor frame	135 x 14.5 x 7	9003414 41000 8	9003414 41000 8	9003414 41000 8	9003414 41000 8
BikeLift®	Standard	33 x 184 x 27.5	9003414 49050 5	9003414 49050 5	9003414 49050 5	9003414 49050 5
	Swivel Mount	33 x 184 x 38.5	9003414 49051 2	9003414 49051 2	9003414 49051 2	9003414 49051 2
Bicycle Hanger BikeMax	1 piece per package	4 x 4 x 185	9003414 49011 6	9003414 49011 6	9003414 49011 6	9003414 49011 6
	2 pieces per package		9003414 49021 5	9003414 49021 5	9003414 49021 5	9003414 49021 5
BikeHolder	set for 3 bikes	72 x 10 x 33	9003414 49012 3	9003414 49012 3	9003414 49012 3	9003414 49012 3
Electric Mounting Panel		20 x 4 x 185	9003414 46031 7	9003414 46031 7	9003414 46031 7	9003414 46031 7
LED Light		44 x 4 x 1.5	9003414 46041 6	9003414 46041 6	9003414 46041 6	9003414 46041 6
Gas springs are standard in the standard equipment! Exceptions: AvantGarde®ECO and additional door ECO						
Gas Spring Set for ECO doors	1 piece per package	34 x 2 x 2	-	-	-	9003414 83608 2
	2 pieces per package	34 x 2 x 2	-	-	-	9003414 83609 9





Accessories Garden Shed Europa and Equipment Locker

Europa	Size	Exterior Dimensions*	Interior Dimensions	Foundation Dimensions	Weight (kg)	EAN Code				
		W x L x H (cm)	W x L x H (cm)	W x L (cm)		Metallic Silver	Metallic Quartz Grey	Metallic Dark Grey	Dark Green	
	Door opening: 135 x 170 cm (W x H).									
	1	172 x 84 x 196	150 x 78 x 188	155 x 83	90.4	9003414 29010 5	9003414 22010 2	9003414 24010 0	9003414 23010 1	
	2	172 x 156 x 196	150 x 150 x 188	155 x 155	115.2	9003414 29020 4	9003414 22020 1	9003414 24020 9	9003414 23020 0	
	3	244 x 156 x 203	222 x 150 x 195	227 x 155	139.4	9003414 29030 3	9003414 22030 0	9003414 24030 8	9003414 23030 9	
	4	244 x 228 x 203	222 x 222 x 195	227 x 227	167.8	9003414 29040 2	9003414 22040 9	9003414 24040 7	9003414 23040 8	
	5	316 x 228 x 209	294 x 222 x 202	299 x 227	202.6	9003414 29050 1	9003414 22050 8	9003414 24050 6	9003414 23050 7	
	6	244 x 300 x 203	222 x 294 x 195	227 x 299	197.8	9003414 29060 0	9003414 22060 7	9003414 24060 5	9003414 23060 6	
	7	316 x 300 x 209	294 x 294 x 202	299 x 299	233.9	9003414 29070 9	9003414 22070 6	9003414 24070 4	9003414 23070 5	
	2A	244 x 84 x 203	222 x 78 x 195	227 x 83	112.2	9003414 29080 8	9003414 22080 5	9003414 24080 3	9003414 23080 4	
	4A	316 x 156 x 209	294 x 150 x 202	299 x 155	165.1	9003414 29090 7	9003414 22090 4	9003414 24090 2	9003414 23090 3	
Additions	Side Canopy for Garden Shed Europa									
	2,3,4A	150 x 156 x 170			21.7	9003414 42019 9	9003414 42012 0	9003414 42014 4	9003414 42040 3	
	4, 5	150 x 228 x 170			27.5	9003414 42029 8	9003414 42022 9	9003414 42024 3	9003414 42050 2	
	6, 7	150 x 300 x 170			35.2	9003414 42039 7	9003414 42032 8	9003414 42034 2	9003414 42060 1	

*highest point, incl. roof overhang

Equipment Locker	Size	Exterior Dimensions*	Interior Dimensions	Foundation Dimensions	Weight (kg)	EAN Code		
		W x L x H (cm)	W x L x H (cm)	W x L (cm)		Metallic Silver	Metallic Quartz Grey	Metallic Dark Grey
	Door opening: Size 90: 65 x 170 cm (W x H), from size 150: 135 x 170 cm (W x H)							
	90	93 x 83 x 182.5	88 x 78 x 177	93 x 83	56.4	9003414 34030 5	9003414 30030 9	9003414 31030 8
	150	155 x 83 x 182.5	150 x 78 x 177	155 x 83	88.1	9003414 34010 7	9003414 30010 1	9003414 31010 0
	150 ^{LARGE}	156 x 155 x 184	150 x 150 x 177	155 x 155	ca. 110.2	9003414 34910 0	9003414 30910 4	9003414 31910 3
	190	191 x 83 x 182.5	186 x 78 x 177	191 x 83	101.4	9003414 34060 2	9003414 30060 6	9003414 31060 5
	190 ^{LARGE}	192 x 155 x 184	186 x 150 x 177	191 x 155	ca. 124.1	9003414 34960 5	9003414 30960 9	9003414 31960 8
	230	227 x 83 x 182.5	222 x 78 x 177	227 x 83	109.9	9003414 34080 0	9003414 30080 4	9003414 31080 3
	230 ^{LARGE}	228 x 155 x 184	222 x 150 x 177	227 x 155	ca. 133.7	9003414 34980 3	9003414 30980 7	9003414 31980 6

*highest point, incl. roof overhang

Foundation Accessories / Foundation suitable for		EAN Code	EAN Code	EAN Code	EAN Code
Equipment Locker		Aluminium Floor Frame	Aluminium Floor Panels	SmartBase	SmartBase ^{PLUS}
Europa	Equipment Locker				
	90	9003414 41011 4	9003414 48011 7	9003414 43982 5	9003414 43482 0
1	150	9003414 41010 7	9003414 48010 0	9003414 43901 6	9003414 43401 1
2	150 ^{LARGE}	9003414 41020 6	9003414 48020 9	9003414 43906 1	9003414 43406 6
	190	9003414 41012 1	9003414 48012 4	9003414 43929 0	9003414 43426 4
	190 ^{LARGE}	9003414 41015 2	9003414 48015 5	9003414 43910 8	9003414 43510 0
2A	230	9003414 41080 0	9003414 48080 3	9003414 43936 8	9003414 43436 3
3	230 ^{LARGE}	9003414 41030 5	9003414 48030 8	9003414 43912 2	9003414 43412 7
4		9003414 41040 4	9003414 48040 7	9003414 43918 4	9003414 43418 9
4A		9003414 41090 9	9003414 48090 2	9003414 43942 9	9003414 43442 4
5, 6		9003414 41050 3	9003414 48050 6	9003414 43923 8	9003414 43423 3
7		9003414 41070 1	9003414 48070 4	9003414 43930 6	9003414 43430 1

Note: Hammer drills can be rented from any well-equipped specialist, however the drill bit required is available from Biohort.

Drill Bit Ø 40 x 570 mm for SDS-MAX chuck Ø 18 mm (for SmartBase^{PLUS}) 9003414 43410 3

Note: If the floor frame is laid directly on a gravel base (approx. 10 cm gravel, without foundation or slabs), ground anchors are required for securing to the ground. Storm resistance must be ensured by the customer. For size 1, 90, 150: 4 pcs. in total; for size 2, 2A 150^{LARGE}, 190, 190^{LARGE}, 230: 6 pcs. in total; for size 3, 4, 4A, 230^{LARGE}: 8 pcs. in total; for size 5, 6, 7: 10 pcs. in total are necessary.

Ground Anchor	4 pieces per package	9003414 41004 6
	6 pieces per package	9003414 41006 0

Accessories	Dimensions W x L x H (cm) / Colour			
Accessories in matching colour				
Additional Door Double	Corrugated, with T-handle cylinder lock and door hooks	Metallic Silver	9003414 29001 3	-
		Metallic Quartz Grey	9003414 22001 0	-
		Metallic Dark Grey	9003414 24001 8	-
		Dark Green	9003414 23001 9	-
Rainwater Downpipe Set		Metallic Silver	9003414 44070 8	-
		Metallic Quartz Grey	9003414 44080 7	-
		Metallic Dark Grey	9003414 44050 0	-
		Dark Green	9003414 44040 1	-
Window Unit		Metallic Silver	9003414 43060 0	-
		Metallic Quartz Grey	9003414 43080 8	-
		Metallic Dark Grey	9003414 43050 1	-
		Dark Green	9003414 43040 2	-

Made from hot-dip galvanised, polyamide coated steel plate.

Shelf Support Rails	2 pieces per package	4 x 4 x 173	9003414 46020 1	9003414 46020 1
Shelves	2 pieces per package	72 x 24.5 x 7	9003414 45010 3	9003414 45010 3
	4 pieces per package	72 x 24.5 x 7	9003414 45020 2	9003414 45020 2
	2 pieces per package	72 x 43.5 x 7	9003414 45030 1	9003414 45030 1
Folding Table		69.2 x 57.5 x 40	9003414 40011 5	9003414 40011 5
Suspension Basket	With wall bracket	67 x 34 x 20	9003414 47071 2	9003414 47071 2
Hook Set	One comb, handle and shovel hook each	72 x 17 x 73	9003414 47070 5	9003414 47070 5
Tool Hangers	4 pieces per package	13 x 9.5 x 30	9003414 47020 0	9003414 47020 0
Door Baskets	2 pieces per package	34 x 10 x 9.5	9003414 46025 6	9003414 46025 6
Shelf Baskets	2 pieces per package	72 x 16 x 11	9003414 46026 3	9003414 46026 3
Electric Mounting Panel		28 x 6 x 172.5	9003414 46030 0	9003414 46030 0
LED Light		44 x 4 x 1.5	9003414 46041 6	9003414 46041 6
Threshold Access Ramp	Only with double door and floor frame	135 x 14.5 x 7	9003414 41000 8	-
	Standard	33 x 184 x 27.5	9003414 49050 5	-
BikeLift®	Swivel Mount	33 x 184 x 38.5	9003414 49051 2	-
	Can only be mounted centrally on the back wall			
Bicycle Hanger BikeMax	1 piece per package	4 x 4 x 173	9003414 49010 9	-
	2 pieces per package		9003414 49020 8	-
BikeHolder	set for 3 bikes	72 x 10 x 33	9003414 49012 3	-

Outdoor Boxes, Bicycle Storage and Dustbin Storage

Romeo®	Size	Exterior Dimensions	Interior Dimensions	Volume	Weight	EAN Code		
		W x L x H (cm)	W x L x H (cm)	(L)	(kg)	Metallic Silver	Metallic Quartz Grey	Metallic Dark Grey
	M	132 x 57 x 140	127 x 46 x 135	800	68.1	9003414 55070 4	9003414 58070 1	9003414 56070 3
	L	132 x 87 x 140	127 x 76 x 135	1300	81.9	9003414 55080 3	9003414 58080 0	9003414 56080 2
Accessories		for size		Dimensions W x L x H (cm)		EAN Code		
Shelves		M, L		61 x 43 x 40 (2-part)		9003414 75055 5		

StoreMax®	Size	Exterior Dimensions	Interior Dimensions	Volume	Weight	EAN Code		
		W x L x H (cm)	W x L (cm)	(L)	(kg)	Metallic Silver	Metallic Quartz Grey	Metallic Dark Grey
	120	117 x 73 x 109	114 x 62	740	48.2	9003414 72060 2	9003414 70060 4	9003414 73060 1
	160	163 x 78 x 120	160 x 67	1200	65.1	9003414 72010 7	9003414 70010 9	9003414 73010 6
	190	190 x 97 x 136	188 x 86	2080	88.8	9003414 72020 6	9003414 70020 8	9003414 73020 5
Accessories		for size		Dimensions W x L x H (cm)		EAN Code		
Corner Shelf Set (triangular)		120, 160		54 x 54 x 53.5		9003414 74010 5		
Intermediate Floor		160		160 (2 x 80) x 59.5 x 53.5		9003414 75010 4		
		190		187 (2 x 93.5) x 74.5 x 53.5		9003414 75020 3		
Shelf Set		190		72 x 24.5 x 53.5		9003414 74020 4		
BikeHolder		190		72 x 15 x 33		9003414 74030 3		

HighBoard	Size	Exterior Dimensions	Interior Dimensions	Volume	Weight	EAN Code		
		W x L x H (cm)	W x L x H (cm)	(L)	(kg)	Metallic Silver	Metallic Quartz Grey	Metallic Dark Grey
	160	160.5 x 70.5 x 118	156 x 62 x 113	1150	82.7	9003414 72015 2	9003414 70015 4	9003414 73015 1
	200	200.5 x 84.5 x 127	195 x 76 x 120	2150	114.5	9003414 72025 1	9003414 70025 3	9003414 73025 0
Accessories		for size		Dimensions W x L x H (cm)		EAN Code		
Tool Holder		160, 200		51.6 x 3.5 x 5		9003414 47031 6	9003414 47081 1	9003414 47051 4
Lid Storage Net		160, 200		25 x 67 x 2		9003414 67010 5		
Intermediate Floor		160		78 x 30 x 53.5 per shelf (4-pieces)		9003414 75015 9		
		200		97 x 74 x 53.5 per shelf (2-pieces)		9003414 75025 8		
Suspension Basket, Type B		160		54.5 x 50 x 20		9003414 67071 6		
Suspension Basket, Type C		200		68.5 x 67 x 20		9003414 67072 3		
BikeHolder		200		72 x 10 x 33		9003414 49012 3		
Electric Mounting Panel		200		58 x 2 x 23		9003414 46032 4		

LoungeBox®	Size	Exterior Dimensions	Interior Dimensions	Volume	Weight	EAN Code		
		W x L x H (cm)	W x L x H (cm)	(L)	(kg)	Metallic Silver	Metallic Quartz Grey	Metallic Dark Grey
	160	160 x 70 x 83.5	159 x 66 x 77	850	50.1	9003414 64065 8	9003414 68065 4	9003414 65065 7
	200	200 x 85 x 90	199 x 80 x 81	1400	71.9	9003414 64075 7	9003414 68075 3	9003414 65075 6
Accessories		for size		Dimensions W x L x H (cm)		EAN Code		
Lid Storage Net		for all sizes		25 x 67 x 2		9003414 67010 5		
Suspension Basket, Type B		160		54.5 x 50 x 20		9003414 67071 6		
Suspension Basket, Type C		200		68.5 x 67 x 20		9003414 67072 3		

StyleBox®	Size	Exterior Dimensions	Interior Dimensions	Volume	Weight	EAN Code		
		W x L x H (cm)	W x L x H (cm)	(L)	(kg)	Metallic Silver	Metallic Quartz Grey	Metallic Dark Grey
	140	140 x 60 x 71	129 x 49 x 63	400	42,8	9003414 19830 2	9003414 19832 6	9003414 19831 9
	170	170 x 70 x 81	159 x 59 x 73	685	57,7	9003414 19833 3	9003414 19835 7	9003414 19834 0
	210	207 x 80 x 81	196 x 69 x 73	990	73,4	9003414 19836 4	9003414 19838 8	9003414 19837 1
Accessories		for size		Dimensions W x L x H (cm)		EAN Code		
Lid Storage Net		for all sizes		25 x 67 x 2		9003414 67010 5		
Suspension Basket Type D		140		48.5 x 50.5 x 20		9003414 67073 0		
Suspension Basket Type E		170		59 x 50.5 x 20		9003414 67074 7		
Suspension Basket Type C		210		68.5 x 67 x 20		9003414 67072 3		
Castors		for all sizes		4.5 x 3.5 x 3.5		9003414 67030 3		

LeisureTime Box	Size	Exterior Dimensions	Interior Dimensions	Volume	Weight	EAN Code				
		W x L x H (cm)	W x L x H (cm)	(L)	(kg)	White	Metallic Silver	Met. Quartz Grey	Met. Dark Grey	Metallic Bronze
	100	101 x 46 x 61	92 x 37.5 x 56	195	19.4	9003414 61010 1	9003414 64010 8	9003414 68010 4	9003414 65010 7	9003414 62010 0
	130	134 x 62 x 71	125 x 53.5 x 66	460	31.5	9003414 61040 8	9003414 64040 5	9003414 68040 1	9003414 65040 4	9003414 62040 7
	160 ^{HIGH}	160 x 79 x 83	151 x 70.5 x 78	830	47.5	9003414 61060 6	9003414 64060 3	9003414 68060 9	9003414 65060 2	9003414 62060 5
	180	181 x 79 x 71	172 x 70.5 x 66	800	47.7	9003414 61030 9	9003414 64030 6	9003414 68030 2	9003414 65030 5	9003414 62030 8
	200	201 x 79 x 83	192 x 70.5 x 77.5	1050	62.3	9003414 61090 3	9003414 64090 0	9003414 68090 6	9003414 65090 9	9003414 62090 2
Accessories		for size		Dimensions (cm)		EAN Code				
Lid Storage Net		for all sizes		25 x 67 x 2		9003414 67010 5				
Suspension Basket, Type A		100, 160, 180, 200		67 x 34 x 20		9003414 67070 9				
Suspension Basket, Type B		130		54.5 x 50 x 20		9003414 67071 6				
Suspension Basket, Type C		160, 180, 200		68.5 x 67 x 20		9003414 67072 3				
Parcel Box Kit		for all sizes		16.5 x 26.5 x 5		9003414 67020 4				

Parcel Box	Size	Exterior Dimensions	Interior Dimensions	Volume	Weight	EAN Code				
		W x L x H (cm)	W x L x H (cm)	(L)	(kg)	White	Metallic Silver	Met. Quartz Grey	Met. Dark Grey	Met. Bronze
	100	101 x 46 x 61	92 x 37.5 x 56	195	19.9	9003414 61910 4	9003414 64910 1	9003414 68910 7	9003414 65910 0	9003414 62910 3

MiniGarage	Size	Exterior Dimensions	Interior Dimensions	Foundation Dimensions	Weight	EAN Code	
		W x L x H (cm)	W x L x H (cm)	W x L (cm)	(kg)	Metallic Silver	Metallic Dark Grey
	L	145 x 203 x 150	140 x 195 x 143.5	145 x 203	109.4	9003414 55040 7	9003414 56040 6
Accessories		Dimensions W x L x H (cm)			EAN Code		
Aluminium Floor Frame*		140 x 198 x 4			9003414 41032 9		
Ground Anchor**		4 pieces per package (8 pieces are needed in total)			9003414 41004 6		
Aluminium Floor Panels*		131.6 x 189.7 x 0.2			9003414 48032 2		
SmartBase*		140 x 198 x 18			9003414 43938 2		
SmartBase ^{PLUS} *		140 x 198 x 65			9003414 43439 4		
Shelf Set*		77 x 26.8 x 14 per shelf, incl. shelf supports			9003414 45013 4		
Bike Rail*		17.9 x 199.9 x 139.5			9003414 49014 7		
Electric Mounting Panel*		72 x 2.1 x 28			9003414 46039 3		
LED Light		44 x 4 x 1.5			9003414 46041 6		

*Please note that the size of the MiniGarage has changed. The accessories only fit the "Model 2023 / Size L" with the dimensions 145 x 203 x 150 cm. Please check carefully that you have the correct size to use the accessory properly.

**If the floor frame is laid directly on a gravel base (approx. 10 cm gravel, without foundation or slabs), ground anchors are required for securing to the ground. Storm resistance must be ensured by the customer.

Alex®	Exterior Dimensions	Interior Dimensions	Volume	Weight	EAN Code		
	W x L x H (cm)	W x L x H (cm)	(L)	(kg)	Metallic Silver	Metallic Quartz Grey	Metallic Dark Grey
	80 x 88 x 129	74.4 x 80 x 124.7	740	53.7	9003414 53063 8	9003414 58068 8	9003414 54064 4
If 3 or more Dustbin Box Alex® are ordered, a quantity discount is given.							
Left door hinge					9003414 59065 6	9003414 59065 6	9003414 59065 6
Accessories					Metallic Silver	Metallic Quartz Grey	Metallic Dark Grey
Connecting Element		For 2 Alex® units (one connection)			9003414 53067 6	9003414 58067 1	9003414 54067 5
		For 3 Alex® units (two connections)			9003414 53069 0	9003414 58069 5	9003414 54069 9
Matching Cylinder Locks		For 2 Alex® units			9003414 50040 2	9003414 50040 2	9003414 50040 2
		For 3 Alex® units			9003414 50041 9	9003414 50041 9	9003414 50041 9
Shelves		72 x 43.5 x 7			9003414 45030 1	9003414 45030 1	9003414 45030 1
Shelf Support Rails		122 x 3 x 3			9003414 46022 5	9003414 46022 5	9003414 46022 5

BikeLift® for Wall Mounting



BikeLift®	Variant	Exterior Dimensions	Weight	EAN Code	
		W x L x H (cm)	(kg)	Metallic Dark Grey	
	Standard	16 x 38 x 180	9.5	9003414 49054 3	
	Swivel Mount	16 x 53 x 182	13	9003414 49055 0	
Accessories		EAN Code			
Electric Socket Mounting Panel		can be combined with all variants	10 x 12 x 4	0.2	9003414 49059 8

Fits almost any bike. Check your bike: www.biohort.com/bikelift

Planting Bed

Raised Bed	Size	Exterior Dimensions	Interior Dimensions	Volume	Weight	EAN Code		
		W x L x H (cm)	W x L x H (cm)	(L)	(kg)	Metallic Silver	Metallic Quartz Grey	Metallic Dark Grey
	1 x 0.5	102 x 53 x 77	95 x 46 x 77	340	34.6	9003414 64012 2	9003414 68012 8	9003414 65012 1
	1 x 1	102 x 102 x 77	95 x 95 x 77	695	43.2	9003414 64005 4	9003414 68005 0	9003414 65005 3
	1.5 x 0.5	152 x 53 x 77	145 x 46 x 77	515	41.3	9003414 64028 3	9003414 68028 9	9003414 65028 2
	1.5 x 1	152 x 102 x 77	145 x 95 x 77	1060	49.9	9003414 64018 4	9003414 68018 0	9003414 65018 3
	1.5 x 1.5	152 x 152 x 77	145 x 145 x 77	1620	56.6	9003414 64048 1	9003414 68048 7	9003414 65048 0
	2 x 0.5	201 x 53 x 77	194 x 46 x 77	685	51.2	9003414 64022 1	9003414 68022 7	9003414 65022 0
	2 x 1	201 x 102 x 77	194 x 95 x 77	1450	59.8	9003414 64015 3	9003414 68015 9	9003414 65015 2
	2 x 2	201 x 201 x 77	194 x 194 x 77	2900	76.4	9003414 64035 1	9003414 68035 7	9003414 65035 0
	L 2 x 1	201 x 201 x 77	194 x 194 x 77	2180	82.6	9003414 64025 2	9003414 68025 8	9003414 65025 1

Accessories	for size	Dimensions W x L x H (cm)	Metallic Silver	Metallic Quartz Grey	Metallic Dark Grey
Intermediate Floor	1 x 0.5	98 x 51 x 3	-	-	9003414 65042 8
	1 x 1	98 x 100 x 3	-	-	9003414 65046 6
	1.5 x 0.5	147 x 51 x 3	-	-	9003414 65045 9
	2 x 0.5	196 x 51 x 3	-	-	9003414 65043 5
	1.5 x 1	147 x 98 x 3	-	-	9003414 65049 7
	2 x 1	196 x 100 x 3	-	-	9003414 65047 3
Cold Frame Extension	2 x 1	200 x 101 x 23	9003414 64013 9	9003414 68013 5	9003414 65013 8
Snail Guard	1 x 0.5	110 x 61 x 4.2	9003414 16349 2	9003414 16351 5	9003414 16350 8
	1 x 1	110 x 110 x 4.2	9003414 16370 6	9003414 16372 0	9003414 16371 3
	1.5 x 0.5	160 x 61 x 4.2	9003414 16367 6	9003414 16369 0	9003414 16368 3
	2 x 0.5	209 x 61 x 4.2	9003414 16355 3	9003414 16357 7	9003414 16356 0
	1.5 x 1	160 x 61 x 4.2	9003414 16364 5	9003414 16366 9	9003414 16365 2
	2 x 1	209 x 110 x 4.2	9003414 16352 2	9003414 16354 6	9003414 16353 9
	1.5 x 1.5	160 x 160 x 4.2	9003414 16361 4	9003414 16363 8	9003414 16362 1
	2 x 2	209 x 209 x 4.2	9003414 16373 7	9003414 16375 1	9003414 16374 4
Skirting	1 x 0.5	115 x 66.4 x 6.3	9003414 16399 7	9003414 16401 7	9003414 16400 0
	1 x 1	115 x 115 x 6.3	9003414 16396 6	9003414 16398 0	9003414 16397 3
	1.5 x 0.5	164 x 66.4 x 6.3	9003414 16393 5	9003414 16395 9	9003414 16394 2
	2 x 0.5	214 x 66.4 x 6.3	9003414 16382 9	9003414 16384 3	9003414 16383 6
	1.5 x 1	164 x 115 x 6.3	9003414 16390 4	9003414 16392 8	9003414 16391 1
	2 x 1	214 x 115 x 6.3	9003414 16379 9	9003414 16381 2	9003414 16380 5
	1.5 x 1.5	164 x 164 x 6.3	9003414 16385 0	9003414 16387 4	9003414 16386 7
	2 x 2	214 x 214 x 6.3	9003414 16376 8	9003414 16378 2	9003414 16377 5
	L2 x 1	214 x 214 x 6.3	9003414 16408 6	9003414 16410 9	9003414 16409 3
Trellis (1 pc.) (With L-size is 1 pc. also possible)	for 1 m side	102 x 4 x 91	9003414 16436 9	9003414 16438 3	9003414 16437 6
	for 1.5 m side	152 x 4 x 91	9003414 16439 0	9003414 16441 3	9003414 16440 6
	for 2 m side	201 x 4 x 91	9003414 16442 0	9003414 16444 4	9003414 16443 7
Trellis L Form (2 pcs.)	1 x 1	102 x 102 x 91	9003414 16445 1	9003414 16447 5	9003414 16446 8
	1.5 x 1.5	152 x 152 x 91	9003414 16448 2	9003414 16450 5	9003414 16449 9
	2x2, L2x1	201 x 201 x 91	9003414 16451 2	9003414 16453 6	9003414 16452 9
Privacy Screen (1 pc.) (With L-size is 1 pc. also possible)	for 1 m side	102 x 4 x 91	9003414 16457 4	9003414 16459 8	9003414 16458 1
	for 1.5 m side	152 x 4 x 91	9003414 16460 4	9003414 16462 8	9003414 16461 1
	for 2 m side	201 x 4 x 91	9003414 16463 5	9003414 16465 9	9003414 16464 2
Privacy Screen L Form (2 pcs.)	1 x 1	102 x 102 x 91	9003414 16466 6	9003414 16468 0	9003414 16467 3
	1.5 x 1.5	152 x 152 x 91	9003414 16469 7	9003414 16471 0	9003414 16470 3
	2x2, L2x1	201 x 201 x 91	9003414 16472 7	9003414 16474 1	9003414 16473 4
Privacy Screen with Glass Panels (1 pc.) (With L-size is 1 pc. also possible)	for 1 m side	102 x 4 x 91	9003414 16475 8	9003414 16477 2	9003414 16476 5
	for 1.5 m side	152 x 4 x 91	9003414 16478 9	9003414 16480 2	9003414 16479 6
	for 2 m side	201 x 4 x 91	9003414 16481 9	9003414 16483 3	9003414 16482 6
Privacy Screen L Form with Glass Panels (2 pcs.)	1 x 1	102 x 102 x 91	9003414 16484 0	9003414 16486 4	9003414 16485 7
	1.5 x 1.5	152 x 152 x 91	9003414 16487 1	9003414 16489 5	9003414 16488 8
	2x2, L2x1	201 x 201 x 91	9003414 16490 1	9003414 16492 5	9003414 16491 8

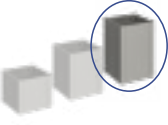
Belvedere®	Size	Exterior Dimensions	Interior Dimensions	Volume	Weight	EAN Code		
		W x L x H (cm)	W x L x H (cm)	(L)	(kg)	Metallic Silver	Metallic Quartz Grey	Metallic Dark Grey
	Height: 45 cm							
	50 ^{MINI}	53 x 53 x 45	46 x 46 x 45	42	19.8	9003414 15888 7	9003414 15875 7	9003414 15853 5
	100 ^{MINI}	102 x 53 x 45	95 x 46 x 45	90	27.3	9003414 15887 0	9003414 15874 0	9003414 15852 8
	150 ^{MINI}	152 x 53 x 45	145 x 46 x 45	135	33.7	9003414 15885 6	9003414 15872 6	9003414 15850 4
	200 ^{MINI}	201 x 53 x 45	194 x 46 x 45	180	39.9	9003414 15882 5	9003414 15869 6	9003414 15847 4
	L100 ^{MINI}	102 x 102 x 45	95 x 95 x 45	130	38.8	9003414 15878 8	9003414 15865 8	9003414 15856 6
	L150 ^{MINI}	152 x 152 x 45	145 x 145 x 45	225	53.5	9003414 15877 1	9003414 15864 1	9003414 15855 9
	L200 ^{MINI}	201 x 201 x 45	194 x 194 x 45	315	66.5	9003414 15876 4	9003414 15863 4	9003414 15854 2
	Height: 61 cm							
	50 ^{MIDI}	53 x 53 x 61	46 x 46 x 61	42	23.8	9003414 15940 2	9003414 15919 8	9003414 15904 4
	100 ^{MIDI}	102 x 53 x 61	95 x 46 x 61	90	32.9	9003414 15939 6	9003414 15918 1	9003414 15903 7
	150 ^{MIDI}	152 x 53 x 61	145 x 46 x 61	135	40.6	9003414 15937 2	9003414 15915 0	9003414 15901 3
	200 ^{MIDI}	201 x 53 x 61	194 x 46 x 61	180	48.3	9003414 15934 1	9003414 15911 2	9003414 15898 6
	L100 ^{MIDI}	102 x 102 x 61	95 x 95 x 61	130	46.4	9003414 15930 3	9003414 15907 5	9003414 15891 7
	L150 ^{MIDI}	152 x 152 x 61	145 x 145 x 61	225	64	9003414 15929 7	9003414 15906 8	9003414 15890 0
	L200 ^{MIDI}	201 x 201 x 61	194 x 194 x 61	315	79.8	9003414 15927 3	9003414 15905 1	9003414 15889 4
	Height: 77 cm							
	50 ^{MAXI}	53 x 53 x 77	46 x 46 x 77	42	27.8	9003414 16021 7	9003414 16008 8	9003414 15953 2
	100 ^{MAXI}	102 x 53 x 77	95 x 46 x 77	90	38.5	9003414 16020 0	9003414 16007 1	9003414 15952 5
	150 ^{MAXI}	152 x 53 x 77	145 x 46 x 77	135	46.6	9003414 16018 7	9003414 16005 7	9003414 15950 1
	200 ^{MAXI}	201 x 53 x 77	194 x 46 x 77	180	57.5	9003414 16015 6	9003414 16002 6	9003414 15947 1
	L100 ^{MAXI}	102 x 102 x 77	95 x 95 x 77	130	54	9003414 16011 8	9003414 15998 3	9003414 15943 3
	L150 ^{MAXI}	152 x 152 x 77	145 x 145 x 77	225	73.6	9003414 16010 1	9003414 15997 6	9003414 15942 6
	L200 ^{MAXI}	201 x 201 x 77	194 x 194 x 77	315	93	9003414 16009 5	9003414 15996 9	9003414 15941 9

Accessories	for size	Dimensions W x L x H (cm)	Metallic Silver	Metallic Quartz Grey	Metallic Dark Grey
Snail Guard	100	110 x 61 x 4.2	9003414 16349 2	9003414 16351 5	9003414 16350 8
	150	160 x 61 x 4.2	9003414 16367 6	9003414 16369 0	9003414 16368 3
	200	209 x 61 x 4.2	9003414 16355 3	9003414 16357 7	9003414 16356 0
Skirting	50	66.4 x 66.4 x 6.3	9003414 16402 4	9003414 16404 8	9003414 16403 1
	100	115 x 66.4 x 6.3	9003414 16399 7	9003414 16401 7	9003414 16400 0
	150	164 x 66.4 x 6.3	9003414 16393 5	9003414 16395 9	9003414 16394 2
	200	214 x 66.4 x 6.3	9003414 16382 9	9003414 16384 3	9003414 16383 6
	L100	115 x 115 x 6.3	9003414 16414 7	9003414 16416 1	9003414 16415 4
	L150	164 x 164 x 6.3	9003414 16411 6	9003414 16413 0	9003414 16412 3
	L200	214 x 214 x 6.3	9003414 16405 5	9003414 16407 9	9003414 16406 2
Planter Insert	1 piece	50 x 50 x 18		9003414 16424 6	
	2 piece	50 x 50 x 18		9003414 16427 7	
	3 piece	50 x 50 x 18		9003414 16430 7	
	4 piece	50 x 50 x 18		9003414 16433 8	
Trellis (1 pc.) (With L-size is 1 pc. also possible)	100	102 x 4 x 91	9003414 16436 9	9003414 16438 3	9003414 16437 6
	150	152 x 4 x 91	9003414 16439 0	9003414 16441 3	9003414 16440 6
	200	201 x 4 x 91	9003414 16442 0	9003414 16444 4	9003414 16443 7
Trellis for L Form (2 pcs.) (for each of the long sides)	L100	102 x 102 x 91	9003414 16445 1	9003414 16447 5	9003414 16446 8
	L150	152 x 152 x 91	9003414 16448 2	9003414 16450 5	9003414 16449 9
	L200	201 x 201 x 91	9003414 16451 2	9003414 16453 6	9003414 16452 9
Privacy Screen (1 pc.) (With L-size is 1 pc. also possible)	100	102 x 4 x 91	9003414 16457 4	9003414 16459 8	9003414 16458 1
	150	152 x 4 x 91	9003414 16460 4	9003414 16462 8	9003414 16461 1
	200	201 x 4 x 91	9003414 16463 5	9003414 16465 9	9003414 16464 2
Privacy Screen for L Form (2 pcs.) (for each of the long sides)	L100	102 x 102 x 91	9003414 16466 6	9003414 16468 0	9003414 16467 3
	L150	152 x 152 x 91	9003414 16469 7	9003414 16471 0	9003414 16470 3
	L200	201 x 201 x 91	9003414 16472 7	9003414 16474 1	9003414 16473 4
Privacy Screen with Glass Panels (1 pc.) (With L-size is 1 pc. also possible)	100	102 x 4 x 91	9003414 16475 8	9003414 16477 2	9003414 16476 5
	150	152 x 4 x 91	9003414 16478 9	9003414 16480 2	9003414 16479 6
	200	201 x 4 x 91	9003414 16481 9	9003414 16483 3	9003414 16482 6
Privacy Screen with Glass Panels for L Form (2 pcs.) (for each of the long sides)	L100	102 x 102 x 91	9003414 16484 0	9003414 16486 4	9003414 16485 7
	L150	152 x 152 x 91	9003414 16487 1	9003414 16489 5	9003414 16488 8
	L200	201 x 201 x 91	9003414 16490 1	9003414 16492 5	9003414 16491 8

DaVinci®	Version		Exterior Dimensions	EAN Code		
			W x L x H (cm)	Metallic Silver	Metallic Quartz Grey	Metallic Dark Grey
	1	Terrace border with trellis: 1.5 x 1.5 m corner with trellis, graduated on both sides 0.5 m MIDI, 1 m MINI	299.5 x 299.5 x 168	9003414 17335 4	9003414 17346 0	9003414 17345 3
	2	Terrace border with privacy screen: 1.5 m MAXI with privacy screen, 1 x 1 m corner with trellis on one side, 0.5 m MIDI, 0.5 m MINI	250 x 201 x 168	9003414 17347 7	9003414 17349 1	9003414 17348 4
	3	Flower bed: 0.5 m MINI, 0.5 m MIDI and 1 m MAXI	201 x 53 x 77	9003414 17350 7	9003414 17352 1	9003414 17351 4

Configure your own Planter Box System DaVinci® now! www.biohort.com/configurator

Gardening Helpers

MonAmi®	Exterior Dimensions	Interior Dimensions	Volume	Weight	EAN Code
	W x L x H (cm)	W x L x H (cm)	(L)	(kg)	Metallic Dark Grey
	102 x 102 x 84	95 x 95 x 74	725	62.9	9003414 65026 8

Charly®	Size	Exterior Dimensions	Weight	EAN Code
		W x L x H (cm)	(kg)	
	2	78 x 90 x 49	13.5	9003414 68082 1

WoodStock®	Size	Exterior Dimensions*	Interior Dimensions	Foundation Dimensions	Volume	Weight	EAN Code		
		W x L x H (cm)	W x L	W x L (cm)	(m³)	(kg)	Metallic Silver	Metallic Quartz Grey	Metallic Dark Grey
	150	157 x 102 x 199	142 x 70	155 x 83	2.1	48.5	9003414 35010 6	9003414 38010 3	9003414 37010 4
	230	229 x 102 x 199	214 x 70	227 x 83	3.1	54.1	9003414 35020 5	9003414 38020 2	9003414 37020 3
	300	300.7 x 102 x 199	286 x 70	299 x 83	4	64.7	9003414 35040 3	9003414 38040 0	9003414 37040 1
Accessories	for size	Dimensions W x L x H (cm)					EAN Code		
Aluminium Floor Panels	150	141.5 x 69.5 x 0.2				9.9	9003414 48010 0		
	230	213.5 x 69.5 x 0.2				14	9003414 48080 3		
	300	285.5 x 69.5 x 0.2				17.3	9003414 48013 1		
Back Wall	150	145.5 x 1.1 x 196.5				15.7	9003414 35012 0	9003414 38012 7	9003414 37012 8
	230	217.5 x 1.1 x 196.5				22.5	9003414 35022 9	9003414 38022 6	9003414 37022 7
	300	288.6 x 1.1 x 196.5				32.9	9003414 35042 7	9003414 38042 4	9003414 37042 5
Door Package	150	157 x 5 x 171				24	9003414 35001 4	9003414 38001 1	9003414 37001 2
	230	229 x 5 x 171				29	9003414 35002 1	9003414 38002 8	9003414 37002 9

Note: If the floor frame is laid directly on a gravel base (approx. 10 cm gravel, without foundation or slabs), ground anchors are required for securing to the ground. Storm resistance must be ensured by the customer.
For size 150, 230: 6 pcs. in total; for size 300: 10 pcs. in total are necessary.



Ground Anchor	4 pieces per package	9003414 41004 6
	6 pieces per package	9003414 41006 0



*highest point, incl. roof overhang

CleanLine Cleaning Agents

CleanLine		Volume	EAN Code
	Universal Cleaner	With strong dissolving power against grease, oil, algae and dirt of all kinds. Forms a dirt- and water-repellent surface (lotus effect). Perfect for removing fingerprints after assembly.	1000 ml 9003414 99000 5
	Conservation	Protect your Biohort product from environmental influences and at the same time ensure a silky matt shine.	750 ml 9003414 99100 2
	Saver Set	(Universal Cleaner + Conservation)	1000 ml + 750 ml 9003414 99200 9

Privacy Screen

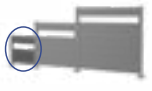
Privacy Screen Panel without Acrylic Glass	Size	Exterior Dimensions	Weight	EAN Code		
		W x L x H (cm)	(kg)	Metallic Silver	Metallic Quartz Grey	Metallic Dark Grey
Height: 90 cm Consists of wall panels and two guide rails for the assembly between two privacy screen posts, can also be attached to a house wall or similar						
	100 x 90	96 x 4.4 x 91	13.2	9003414 15924 2	9003414 15920 4	9003414 15892 4
	150 x 90	145 x 4.4 x 91	17.7	9003414 15925 9	9003414 15921 1	9003414 15893 1
	180 x 90	180 x 4.4 x 91	21.5	9003414 15926 6	9003414 15922 8	9003414 15894 8
	200 x 90	194 x 4.4 x 91	22.9	9003414 15928 0	9003414 15923 5	9003414 15917 4
Height: 135 cm Consists of wall panels and two guide rails for the assembly between two privacy screen posts, can also be attached to a house wall or similar						
	100 x 135	96 x 4.4 x 137	20.3	9003414 15981 5	9003414 15977 8	9003414 15973 0
	150 x 135	145 x 4.4 x 137	27.2	9003414 15982 2	9003414 15978 5	9003414 15974 7
	180 x 135	180 x 4.4 x 137	33.4	9003414 15983 9	9003414 15979 2	9003414 15975 4
	200 x 135	194 x 4.4 x 137	35.5	9003414 15984 6	9003414 15980 8	9003414 15976 1
Height: 180 cm Consists of wall panels and two guide rails for the assembly between two privacy screen posts, can also be attached to a house wall or similar						
	100 x 180	96 x 4.4 x 182	25.7	9003414 16046 0	9003414 16042 2	9003414 16038 5
	150 x 180	145 x 4.4 x 182	34.7	9003414 16047 7	9003414 16043 9	9003414 16039 2
	180 x 180	180 x 4.4 x 182	42.3	9003414 16048 4	9003414 16044 6	9003414 16040 8
	200 x 180	194 x 4.4 x 182	45.1	9003414 16049 1	9003414 16045 3	9003414 16041 5

Privacy Screen Panel with Acrylic Glass	Size	Exterior Dimensions	Weight	EAN Code		
		W x L x H (cm)	(kg)	Metallic Silver	Metallic Quartz Grey	Metallic Dark Grey
Height: 90 cm Consists of wall panels, tinted glass panel and two guide rails for the assembly between two privacy screen posts, can also be attached to a house wall or similar						
	100 x 90	96 x 4.4 x 91	13.1	9003414 15969 3	9003414 15965 5	9003414 15961 7
	150 x 90	145 x 4.4 x 91	17.7	9003414 15970 9	9003414 15966 2	9003414 15962 4
	180 x 90	180 x 4.4 x 91	21.1	9003414 15971 6	9003414 15967 9	9003414 15963 1
	200 x 90	194 x 4.4 x 91	22.3	9003414 15972 3	9003414 15968 6	9003414 15964 8
Height: 135 cm Consists of wall panels, tinted glass panel and two guide rails for the assembly between two privacy screen posts, can also be attached to a house wall or similar						
	100 x 135	96 x 4.4 x 137	20.2	9003414 16034 7	9003414 15989 1	9003414 15985 3
	150 x 135	145 x 4.4 x 137	27.2	9003414 16035 4	9003414 15990 7	9003414 15986 0
	180 x 135	180 x 4.4 x 137	33	9003414 16036 1	9003414 15991 4	9003414 15987 7
	200 x 135	194 x 4.4 x 137	34.9	9003414 16037 8	9003414 15992 1	9003414 15988 4
Height: 180 cm Consists of wall panels, tinted glass panel and two guide rails for the assembly between two privacy screen posts, can also be attached to a house wall or similar						
	100 x 180	96 x 4.4 x 182	25.6	9003414 16058 3	9003414 16054 5	9003414 16050 7
	150 x 180	145 x 4.4 x 182	34.7	9003414 16059 0	9003414 16055 2	9003414 16051 4
	180 x 180	180 x 4.4 x 182	41.9	9003414 16060 6	9003414 16056 9	9003414 16052 1
	200 x 180	194 x 4.4 x 182	44.5	9003414 16229 7	9003414 16057 6	9003414 16053 8

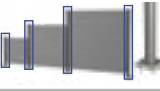
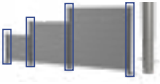
Post for Privacy Screen	suitable for height	Min. Height Max. Height	Base Plate*	Weight	EAN Code		
			W x L (cm)	(kg)	Metallic Silver	Metallic Quartz Grey	Metallic Dark Grey
Post for anchoring They are bolted to the ground. For surface anchoring, the posts can be used as starting, end, corner or connecting post for the privacy screen panels. Choose the wall panels to match the height of the post! Diameter: 10 cm. One post per article.							
	90 cm	95–120	15 x 15	10.5	9003414 16342 3	9003414 16341 6	9003414 16340 9
	135 cm	140–165	15 x 15	11.4	9003414 16345 4	9003414 16344 7	9003414 16343 0
	180 cm	185–210	15 x 15	13.1	9003414 16348 5	9003414 16347 8	9003414 16346 1
Post for setting in concrete Are embedded in a point foundation. For surface anchoring, the posts can be used as starting, end, corner or connecting post for the privacy screen panels. Choose the wall panels to match the height of the post! Diameter: 10 cm. One post per article.							
	90 cm	95–120		10.2	9003414 17336 1	9003414 17342 2	9003414 17339 2
	135 cm	140–165		11.7	9003414 17337 8	9003414 17343 9	9003414 17340 8
	180 cm	185–210		13.8	9003414 17338 5	9003414 17344 6	9003414 17341 5

*The cover plate of the base plate has the dimensions 18 x 18 cm.

Mounting Accessories	For Anchored Post	EAN Code
Hammer Drill Bit	The hammer drill bit is used to drill the required holes in the concrete foundation for the injection mortar. A hammer drill is available in specialist shops.	for SDS plus chuck Ø14 mm Length: 150 millimeters 9003414 18784 9
Blow-out Pump and Cleaning Brush	The pump is used for a safe and easy cleaning of the drill hole. The cleaning brush is used to remove any dust from the sides of the drill hole. This ensures that the injection mortar adheres to the concrete foundation.	9003414 18785 6
Injection Mortar	The injection mortar is required to bond the threaded rod anchors securely in the concrete.	Content 300 ml Sufficient for minimum of 16 pcs. Anchor rods M12 x 160 9003414 18782 5
Applicator Gun	The injection mortar is precisely applied with the aid of the applicator gun. This is achieved by transmission without great effort.	Suitable for 310 ml cartridges 9003414 18783 2
Threaded Rod Anchors	The anchors are glued into the foundation and guarantee a secure connection between foundation and Biohort Privacy Screen including base plate. Per article 4 pcs. – is enough for a post.	M12 x 160 R Includes nuts and washers 9003414 18786 3



Garden Sheds

Rely on Quality & Longevity



Outdoor Boxes

Outdoor Boxes for the Garden, Patio & etc.



Bicycle Storage

Bicycles, Scooter & etc Safely Stowed



Dustbin Storage

Stylish, Practical & Maintenance Free



Gardening Helpers

Garden Design at its Best

Your specialist dealer:



Biohort
stands for
"Life in the
Garden"

Here you can find
our non-binding
recommended
retail prices:



follow us:



Biohort GmbH
Pürnstern 43, 4120 Neufelden, Austria
Tel.: +43(0)7282 / 7788 0
E-Mail: office@biohort.at
www.biohort.com

Technical modifications, misprints and colour
deviations reserved.
ZD101070 - EN