

7x9 Cozy Cabin Playhouse Assembly Manual

Revision # 15
June 27th, 2018

Thank you for purchasing a 7x9 Cozy Cabin. Please take the time to identify all the parts prior to assembly.

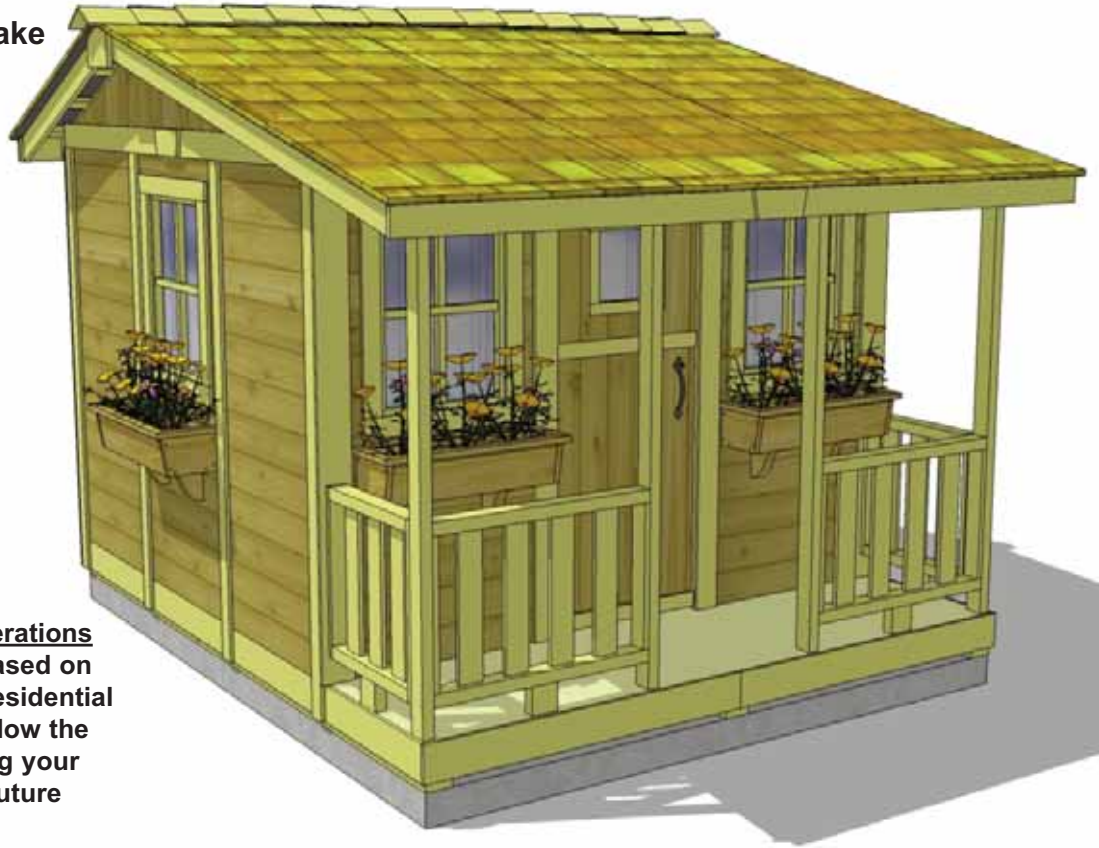

Safety Points and Other Considerations

Our products are built for use based on proper installation and normal residential use, on level ground. Please follow the instruction manual when building your shed and retain the manual for future maintenance purposes.

Some of the safety and usage measures you may wish to consider include:

- snow load ratings vary by geographical location. If heavy or wet snowfall occurs, it is advisable to sweep the snow off the roof(s).
- if the product is elevated, any structural and building code requirements are solely the customer's responsibility, and should be abided by.
- in high or gusty wind conditions it is advisable to keep the structure securely grounded.
- have a regular maintenance plan to ensure screws, doors, windows and parts are tight.

Customer agrees to hold Outdoor Living Today Partnership and any Authorized Dealers free of any liability for improper installation, maintenance and repair.

In the event of a missing or broken piece, simply call the Outdoor Living Today Customer Support Line @ 1-888-658-1658 within 30 days of the delivery of your purchase. It is our commitment to you to courier replacement parts, free of charge, within 10 business days of this notification. Replacement parts will not be provided free of charge after the 30 day grace period.

**Thank you for purchasing our 7x9 Cozy Cabin Playhouse.
Please take the time to identify all the parts prior to assembly.**

Parts Lists:

A. Floor Section

- 2 - 48" x 89" Floor Joist Frames
- 1 - 12" x 89" Floor Joist Frame
- 4 - 1 1/2" x 3 1/2" x 86" Floor Joists
- 3 - 1 1/2" x 3 1/2" x 64" Floor Runners
- 3 - 1 1/2" x 3 1/2" x 44" Floor Runners
- 2 - 48" x 89" Plywood Floor Pieces
- 1 - 12" x 89" Plywood Floor Piece

B. Wall Section

- 7 - 28" x 60" Solid Wall Panels
- 7 - 1 1/2" x 2 1/2" x 28" Bottom Wall Plate
- 4 - 28" x 60" Window Wall Panels
- 1 - 23" x 57 1/2" Door
- 2 - 2 1/4" x 3" x 58 1/2" Door Jambs
- 1 - 1 1/2" x 3" x 28" Door Header
- 4 - Window Inserts

Gable Wall Panels

- 2 - Triangular Gable Walls

Top Wall Plates

- 2 - 3/4" x 2 1/2" x 44 1/2" Front Plates
- 4 - 3/4" x 2 1/2" x 39 1/2" Side Plates
- 2 - 3/4" x 2 1/4" x 44 1/2" Rear Plates (Angle cut @ 22.5 deg. on edge)

Porch Area

- 1 - 3/4" x 2 1/2" x 89" Porch Post Top Connector
- 2 - Short Porch Rail Sections (sides) (20" w x 20" h)
- 2 - Large Porch Rail Sections (front) (29 1/2" w x 20" h)
- 4 - 1 1/2" x 2 1/2" x 54 3/4" Porch Railing Posts (angle cut 13 deg. top)
- 4 - 1 1/2" x 3 1/2" x 3 1/2" Rail Support Blocks

C. Roof Section

- 2 - 3/4" x 3 1/2" x 89" Ridge Boards
- 1 - 1/2" x 4 1/2" x 89" Rear Soffit
- 6 - 1 1/2" x 2 1/2" x 82 1/2" Long Roof Rafters
- 6 - 1 1/2" x 2 1/2" x 39" Short Roof Rafters
- 3 - Long Roof Panels (left/middle/right)
- 3 - Short Roof Panels (left/middle/right)
- 4 pcs (2 @ 3/4"x11/2"x36" & 2 @ 72") - Roof /Facia Nailing Strips

D. Miscellaneous Section

Ridge Caps

- 16 - Cedar Roof Ridge Caps

Bottom Skirting

- 9 - 1/2" x 4 1/2" x 27 3/4" Side & Rear Skirting
- 2 - 1/2" x 4 1/2" x 24" Porch Sides
- 2 - 1/2" x 4 1/2" x 45" Porch Front

Corner & Wall Trim

- 2 - 1/2" x 4 1/2" x 60" Corner Wall Trims - Front
- 2 - 1/2" x 4 1/2" x 64" Corner Wall Trims - Rear
- 10 - 1/2" x 2 1/2" x 64" Narrow Trims
- 2 - 1/2" x 3 1/2" x 60" Vertical Door Trim
- 4 - 1/2" x 3 1/2" x 42 1/2" Horizontal Gable Trims
- 4 - 1/2" x 2 1/2" x 60" Filler Trim

Facia Trim

- 2 - 3/4" x 3 1/2" x 83 1/2" Side Facia for Gables (angle cut on ends)
- 2 - 3/4" x 3 1/2" x 39 3/4" Side Facia for Gables (angle cut on ends)
- 4 - 3/4" x 3 1/2" x 51" Front Facia
- 4 - Detail Plates
- 2 - Pentagon Facia Plate (sides)

Filler Shingles

- 18 - Long Filler Shingles
- 2 - Short Filler Shingles for Long Roof Panell @ 6 3/4"

****Miscellaneous Pieces**

- 4 - Window Inserts
- 4 - Window Trim Pkgs - (1-24 1/16" angle cut / 3 -23" square cut)
- 1 pc - Spare Wall Siding
- 2 pcs - Shim Shingles (use to shim door, etc)
- 4 - Flower Box Kits
- 2 - 1/2" x 5 1/2" x 25 1/2" Front Outside Soffits
- 1 - 1/2" x 5 1/2" x 26 1/2" Front Center Soffit

Note: All Trim, Facia and Bottom Skirting pieces will be positioned rough face out when installed.

7x9 Cozy Cabin Playhouse

Hardware Kit (Provided)

Note: screws and nails shown actual size.

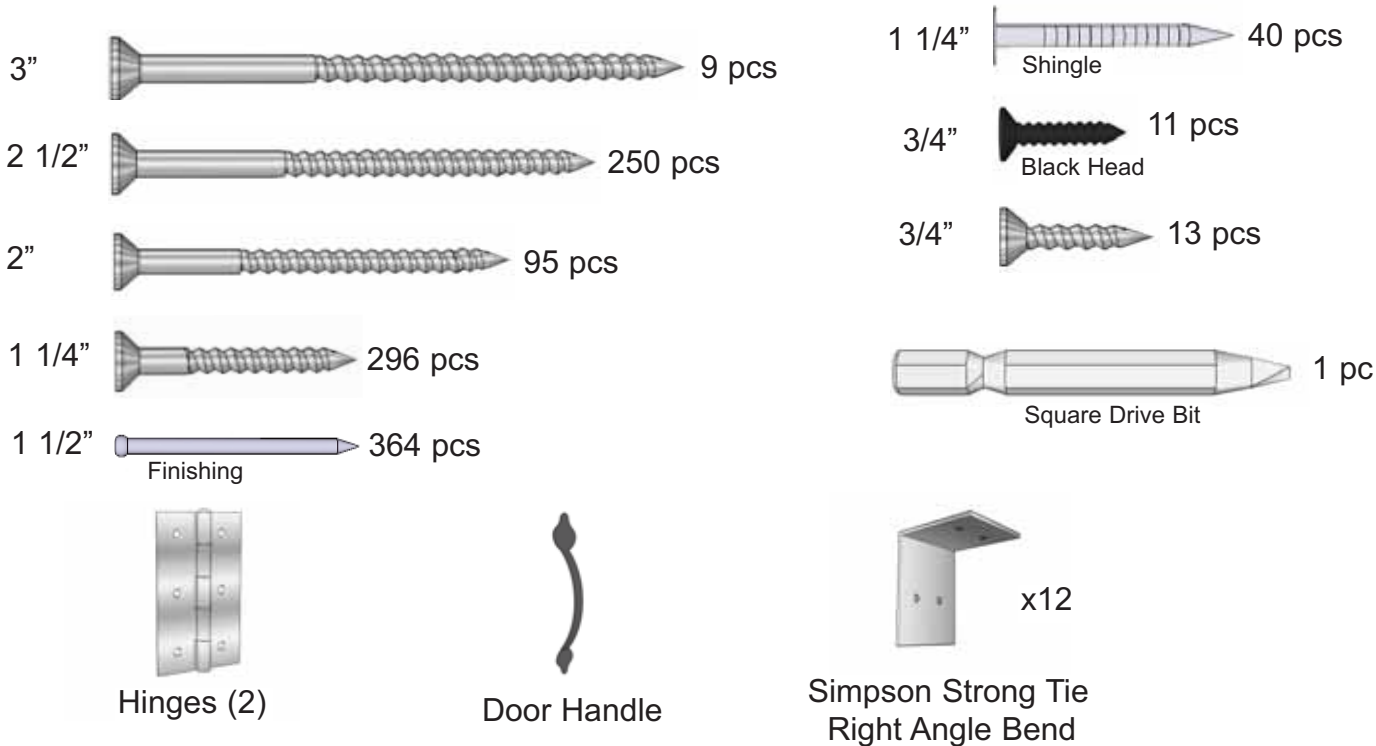

Tools Required (Not Provided)



Safety Equipment Required (Not Provided)



A. Floor Section



You can find the Square Drive Bit for the screws in with the Hardware Kit Bag.

1. Attach Interior Floor Joists to 48" Wide Floor Joist Frames. Measure and attach both Joists with 2 - 2 1/2" screws per joist end as illustrated to the right.

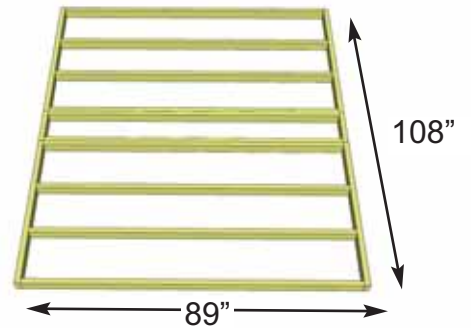
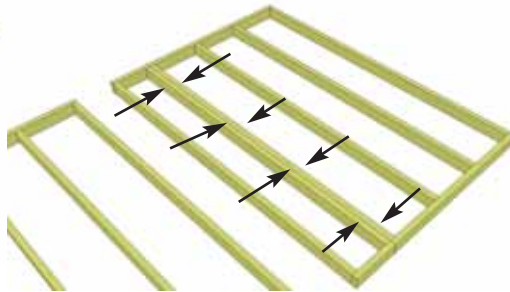
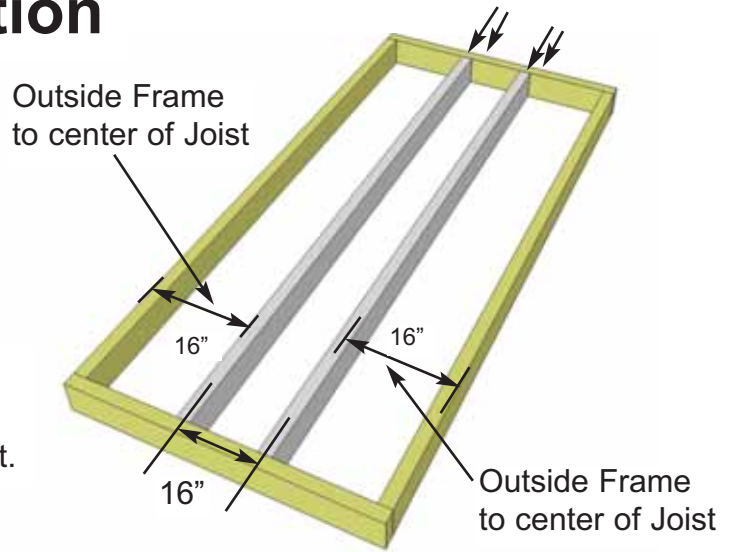

2. Lay out Floor Joist Frames. Attach the Floor Joist Frames together with 2.5" screws. Use 8 screws per section to properly secure frames together. When completed, your Floor Joist section should be 89" wide x 108" deep.

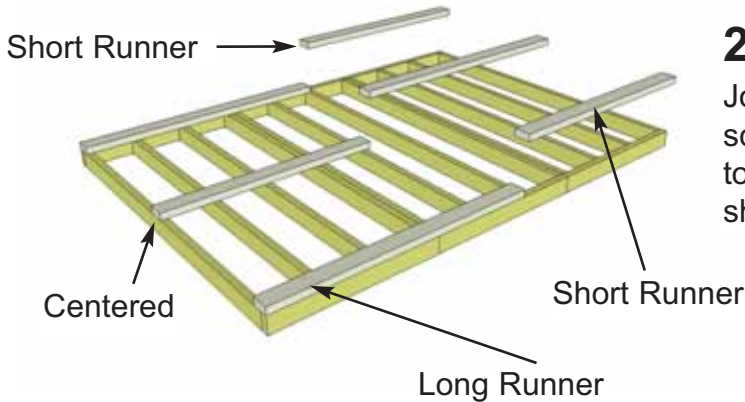

3. Attach Floor Runners to completed Floor Frame. There are two Floor Runners per 108" side and three completed runners in total. Use 4 - 2.5" screws/runner.

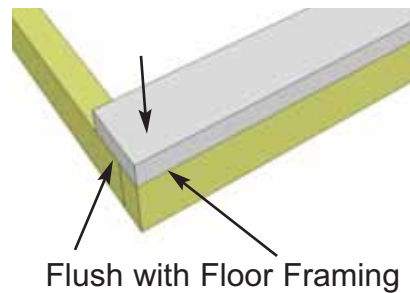

Foundations

NOTE: The floor will be flipped over and the Floor Runners will sit on your foundation. It is important to note that having a level foundation is critical. Choosing a foundation will vary between regions. Typical foundations can be concrete pads or patio stones positioned underneath the floor runners.

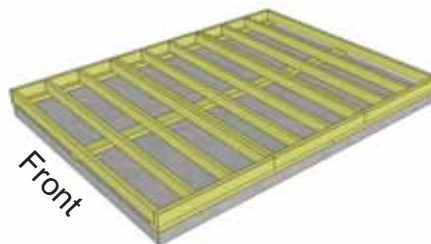
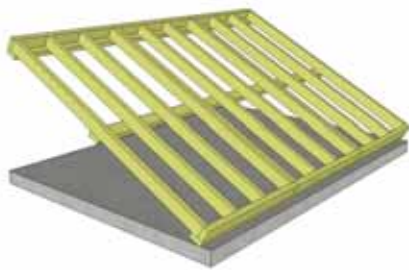

4. With Floor Runners attached, carefully flip the floor over and place on your foundation. CAUTION: You will need two people to assist you. Be careful not to bend or twist the floor when laying floor down. When in place, level floor completely.

5. Position **Plywood Floor** pieces (3) on top of completed Floor Joists. Position **Plywood Floor** piece on top of completed Floor Joists. Plywood will sit slightly back from outside edge of Floor Joist Framing. When in correct position, attach with 1 1/4" screws. Use screws every 16". The Plywood is cut slightly smaller than floor framing. Keep plywood seams tight.

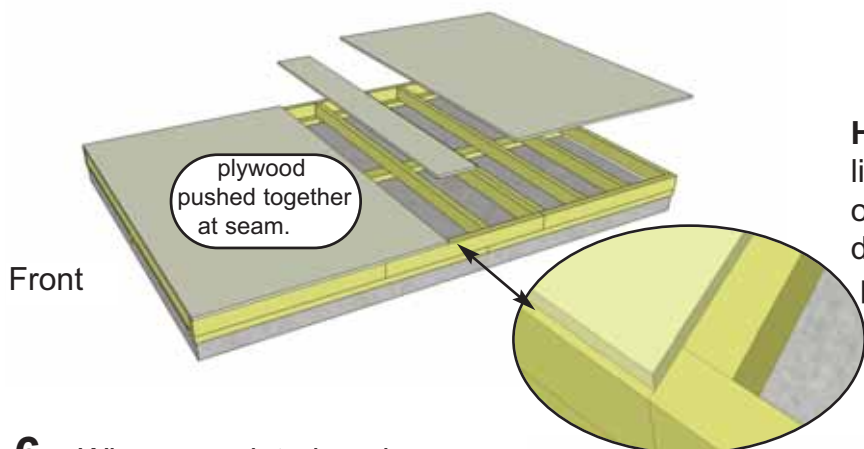
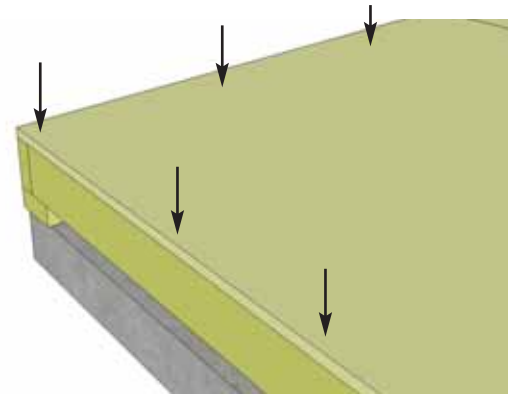

HINT: Use a chalk line to mark location of Floor Joists to determine screw placement.



6. When completed, make sure the floor is still level and make adjustments if required. When completed, your floor should look similar to this.

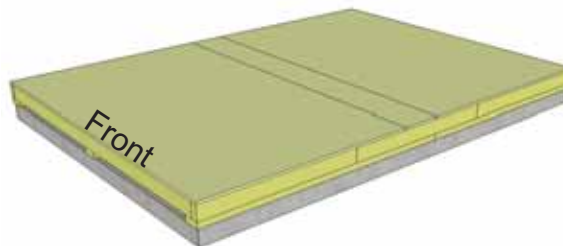

IMPORTANT: Make sure floor is level before moving on to wall section. Use a level to confirm and shim floor joists as required.

B. Wall Section

IMPORTANT: Window Walls and Solid Walls can be positioned at any location but Door must be positioned in the front center.

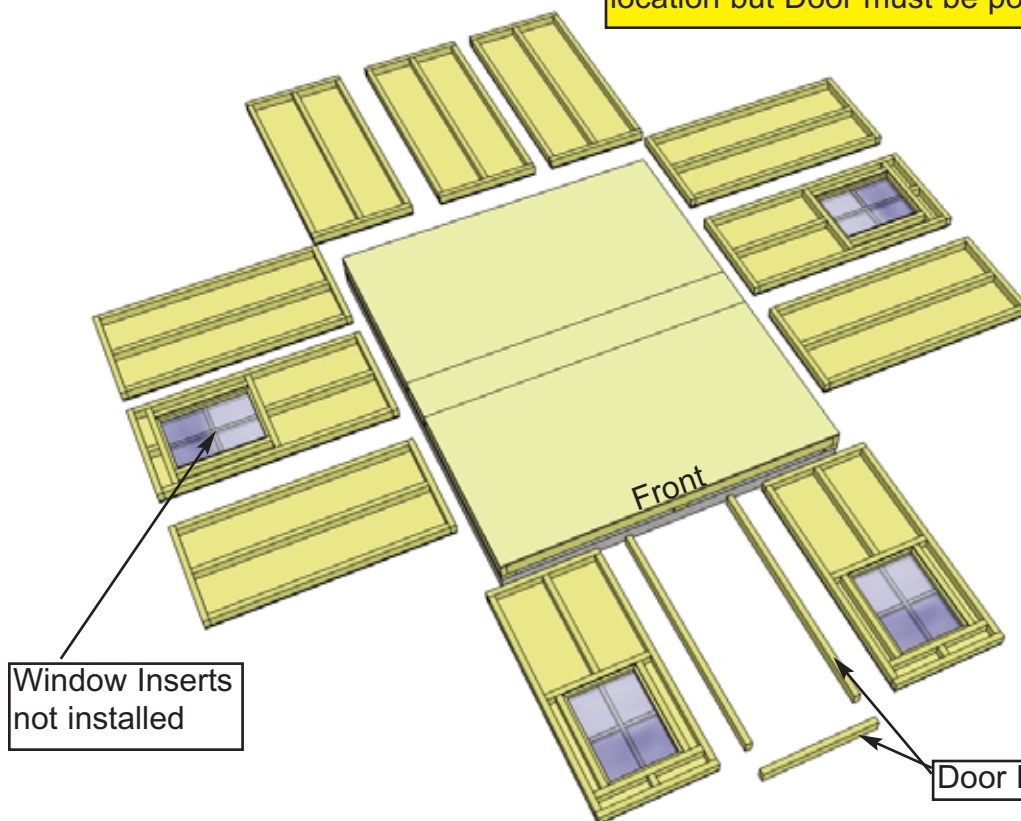

7. Lay out all the Wall Panels and become familiar with their location.

On standard kits, there are **Four Window Wall Panels** and **Seven Solid Wall Panels**.

Make sure to position panels right side up so water is directed away from and not into shed. Look at Window Wall Panels to determine proper siding orientation.

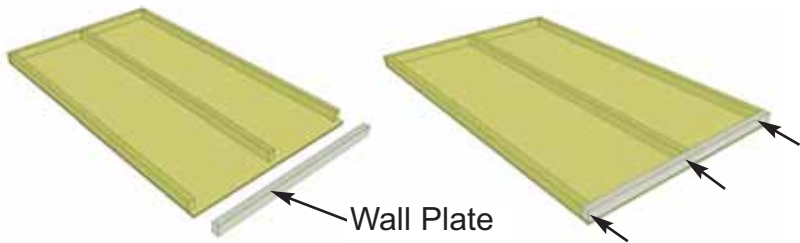

8. Starting with All **Solid Wall Panels**, carefully lay panel face down. Position and attach **Bottom Wall Plates** to bottom of wall studs of each wall panel with 3 - 2 1/2" screws. Position so Wall Plates are flush with framing.

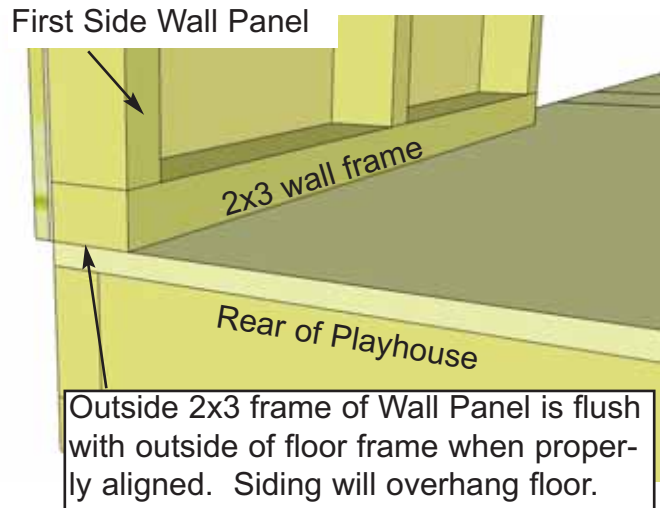
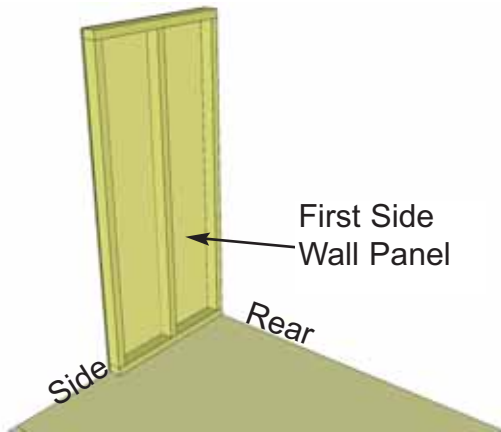

9. Starting at rear corner, position a **Solid Wall Panel** on top of Plywood Floor. Make sure panel is facing up. **IMPORTANT:** Make sure all walls are aligned in their upright position. If not, water may leak into your shed. Unsure if panel is facing up or down? Check the siding on Window Wall Panel to match alignment.

Optional - Caulking seams will help prevent moisture from entering at seam.
Caulking not included in kit.

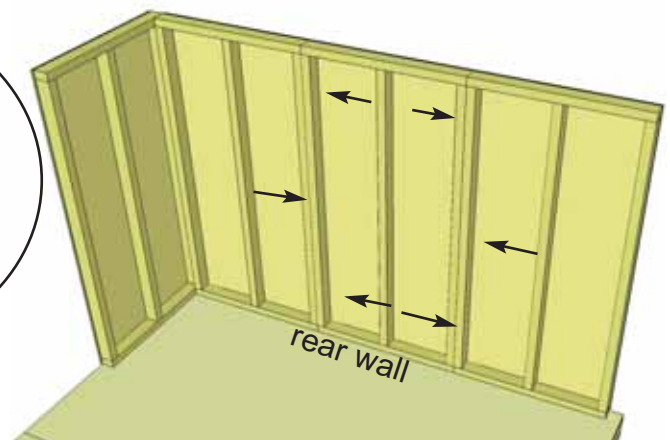
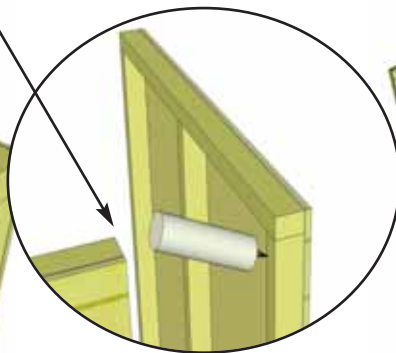

IMPORTANT:
Do not fasten walls to floor until Step 17.

10. Position first Rear Wall Panel on Plywood Floor so once again 2x3 Wall Plate is sitting flush on floor. Position panel so 2x3 framing sits flush with rear wall framing. Siding will overhang floor. When both wall panels are positioned correctly, attach together at top, middle and bottom of vertical studs with 2 1/2" screws. Position and attach second and third rear wall panels as shown above. Attach wall studs together with 3 - 2 1/2" screws.

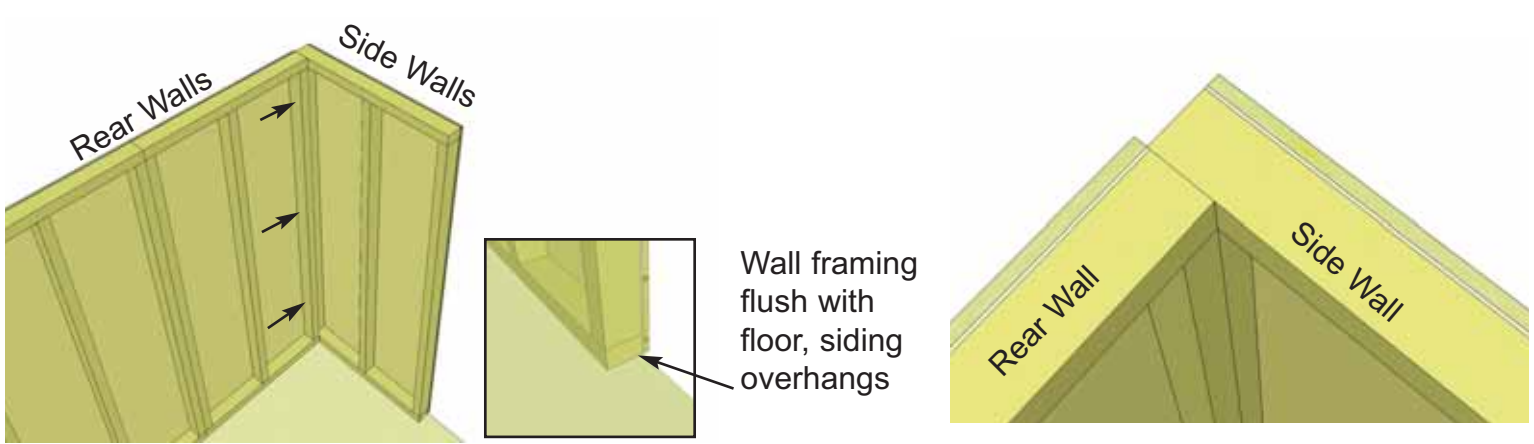

11. Position and attach next Side Wall Panel as per **Steps 9-10**. When correctly aligned, looking from the top view, 2x3 wall framing of corner wall panels will be positioned as illustrated above.



12. Locate **Window Inserts** and **Window Trim Packages**. Before installing, run a bead of caulking around window opening perimeter. Position window in cavity and secure with 8 - 1 1/4" screws. Position Window Trim around window doing a dry run first and attach with 4 - 1 1/2" finishing nails per piece. **Trim Sizes = 1 x 24 1/16" = top / 3 x 23" = Sides & Bottom.**

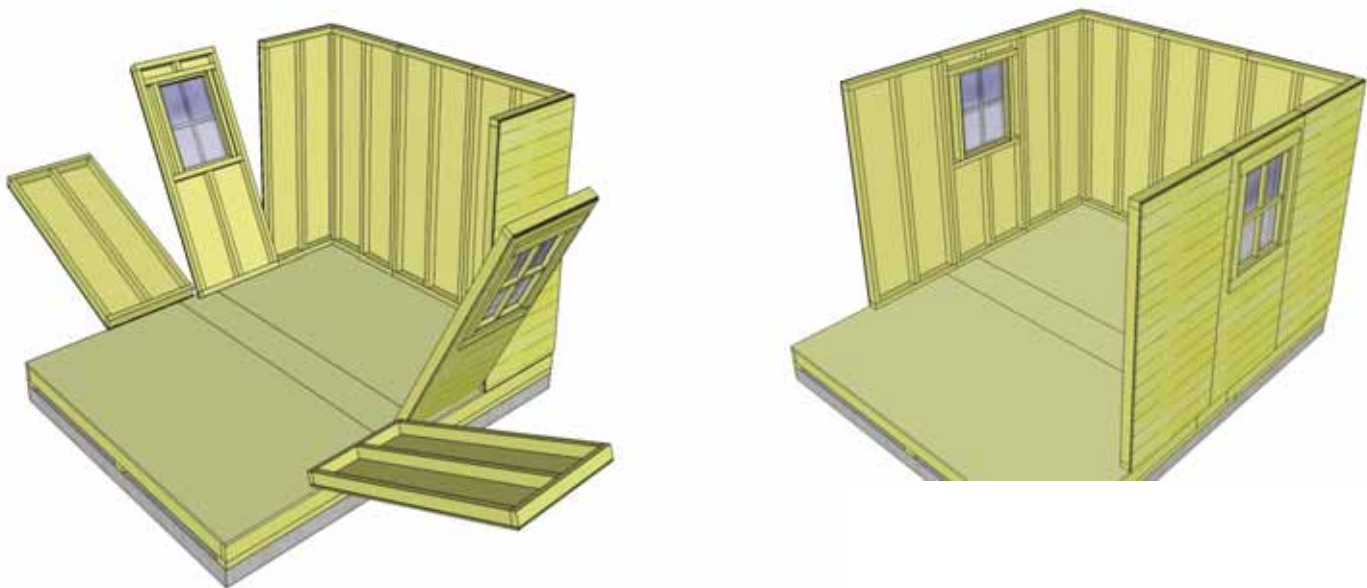

13. Position and attach all remaining Side Wall Panels. Position and attach per **Steps 9-10**.

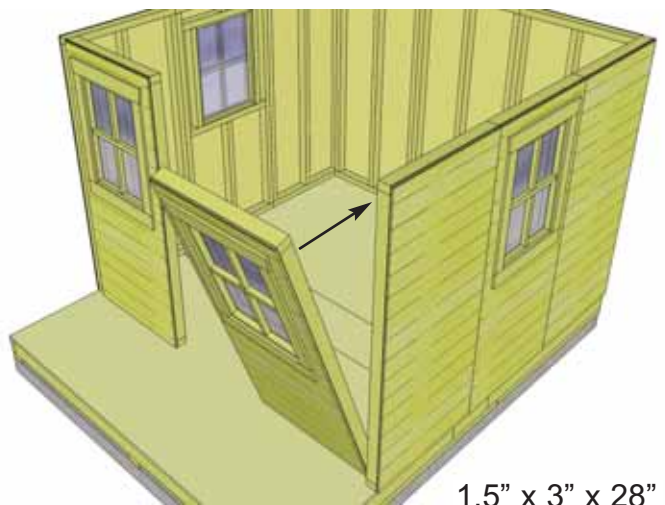
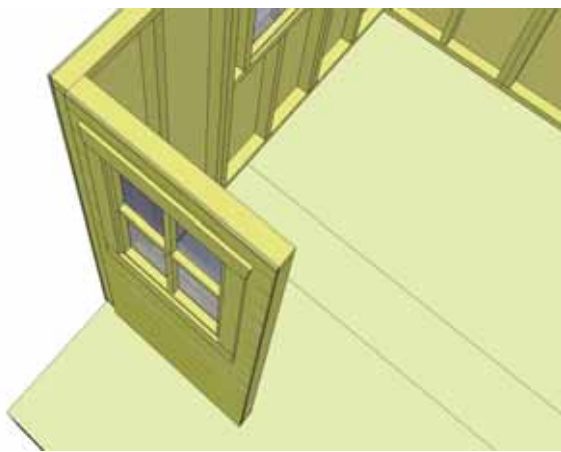

14. Position and attach both Window Walls as per **Steps 9-11**.

1.5" x 3" x 28"
Door Header

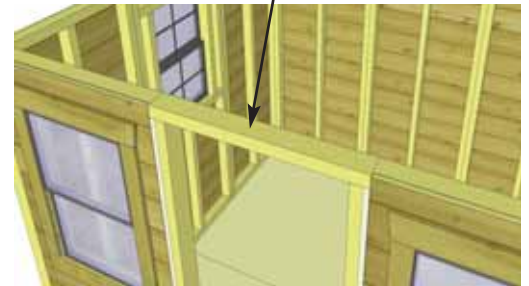
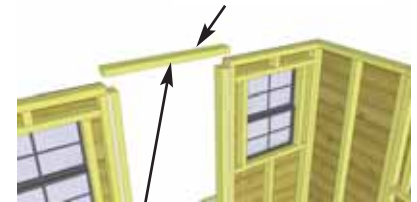
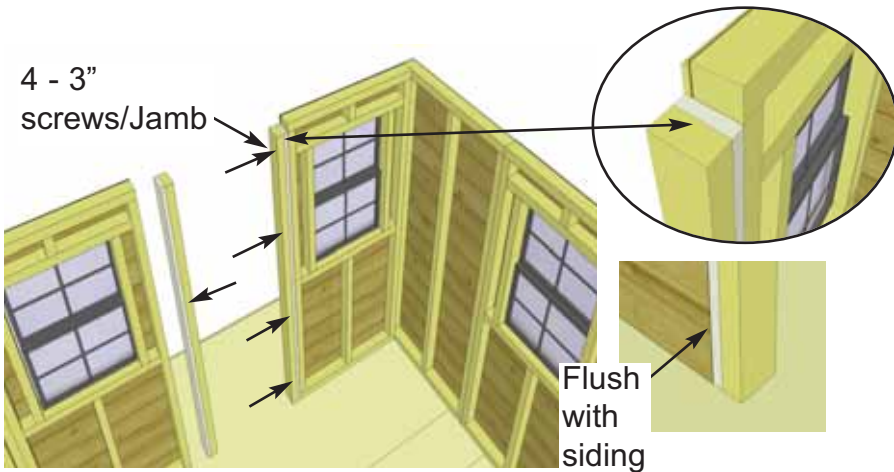

15. Attach both **Vertical Door Jambs** to door opening wall studs with 4 - 3" **screws** per Jamb. Position so Jamb is flush with outside wall siding. Jambs have cleat attached. Position cleat against wall.

16. Attach **Door Header** to vertical Door Jambs with 2 - 2 1/2" screws per side. Make sure Door Jamb is flush with outside wall paneling once again. Screw from Door Header into Door Jambs.

17. When all walls are attached together, check alignment with the floor. Bottom of wall frame should sit flush with outside of floor framing, with siding overhanging by approximately 1/2".

Confirm a 23 1/2" wide doorway opening at bottom. When positioned correctly, fasten Bottom Wall Plates to floor using 2 - 2 1/2" screws per wall panel.

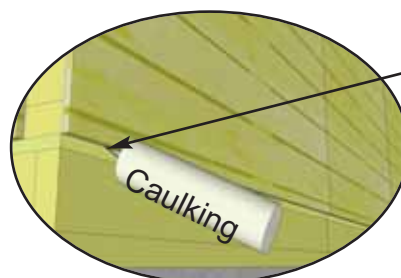
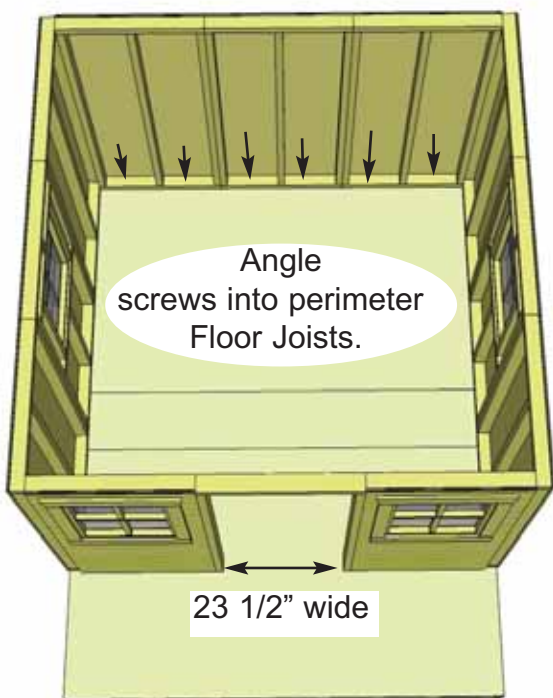

Optional - Caulking seams will help prevent moisture from entering at seam. **Caulking not included in kit.**

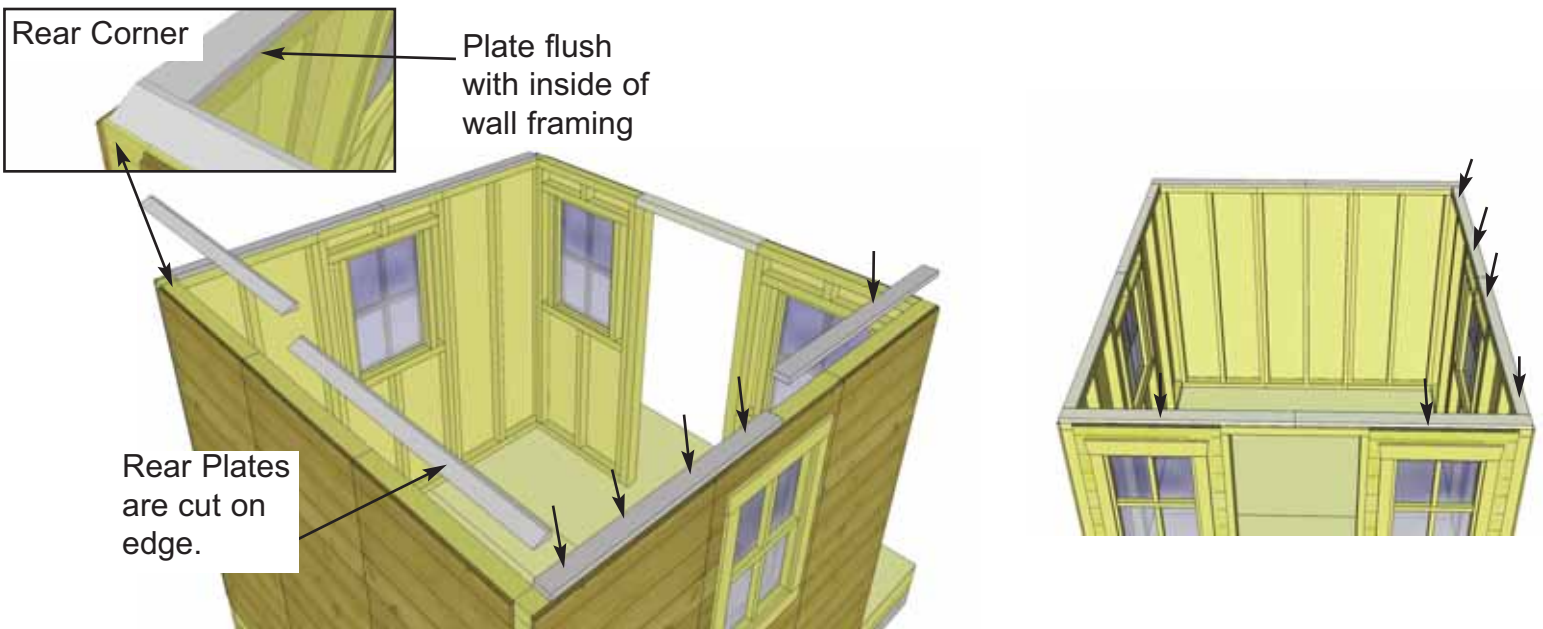

18. Attach Top Plate to top wall panels. Side Plates are 39 1/2" long while the Front and Rear Wall Plates are 44 1/2" long. Rear Plates are cut on edge Use 4 - 2" screws to secure each plate.



19. Locate **Door** and **Door Hinges**. Position door facing down and attach Hinges to door framing with 3/4" screws. Complete both Hinges.



20. Place Door between Door Jamb and Header, leaving an equal space from side to side. Leave a 1/4" gap between floor and bottom of Door. Use supplied Shim Shingles to help in positioning Door. With Door correctly positioned, attach Hinges to Door Jamb with 3/4" Silver Screws. Before completely securing all screws, check door alignment by opening and closing door. Adjust hinges as necessary.

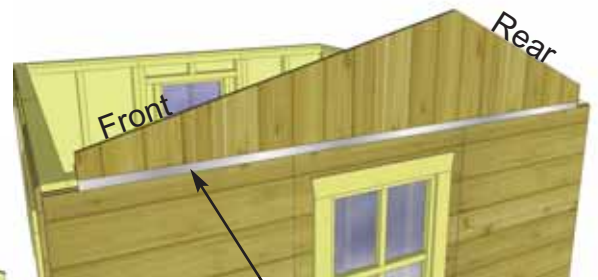
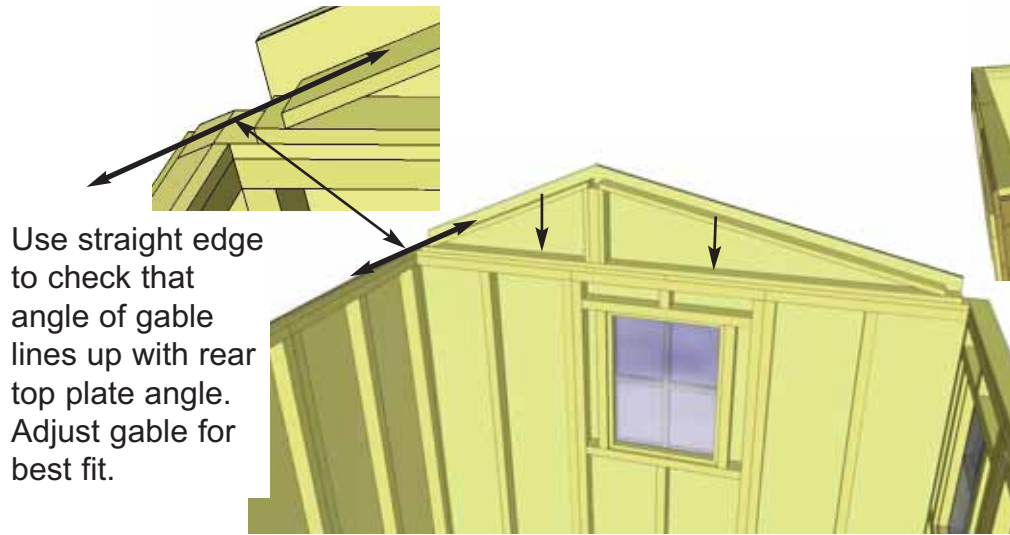

21. Place **Gable Wall** so 1x3 framing sits flush with the inside of the top plate. It should also be centered sideways on the top plate. Adjust gable accordingly. Temporarily attach to walls and top plate with 2 - 2" screws. Gables may need slight adjustment in **Step 41**. Complete attachment in **Step 41** with an additional 6 - 2" screws. Screw from the bottom of gable framing down into Top Plate and Wall. **Hint:** Use a straight edge to check the angle of the gable framing and top plate. Both angles should line up.

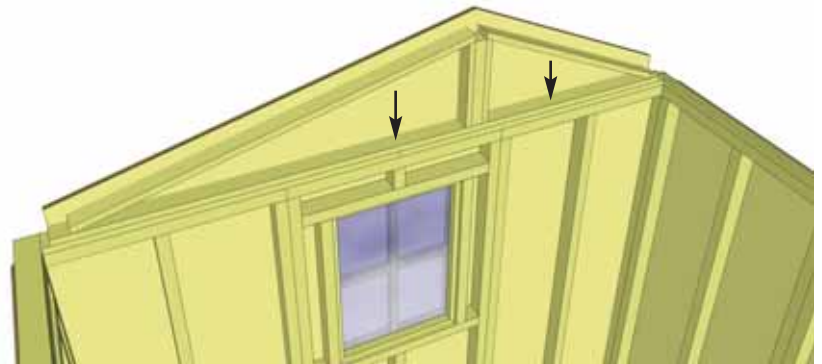
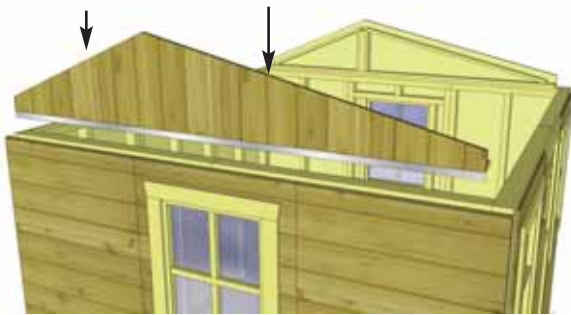

22. Complete 2nd Gable Wall as per **Step 21**.

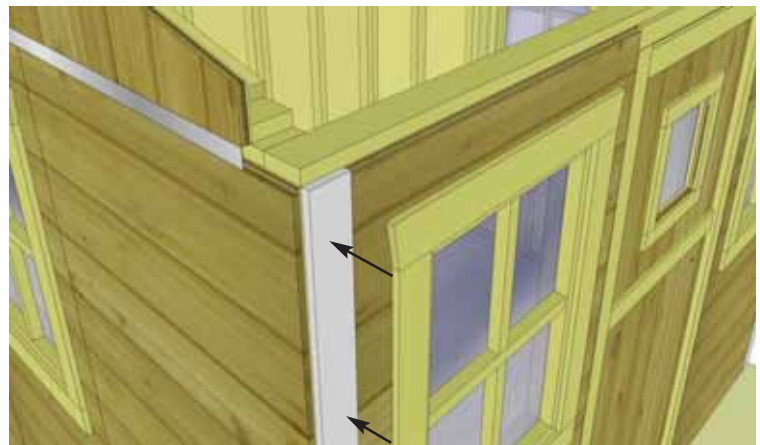
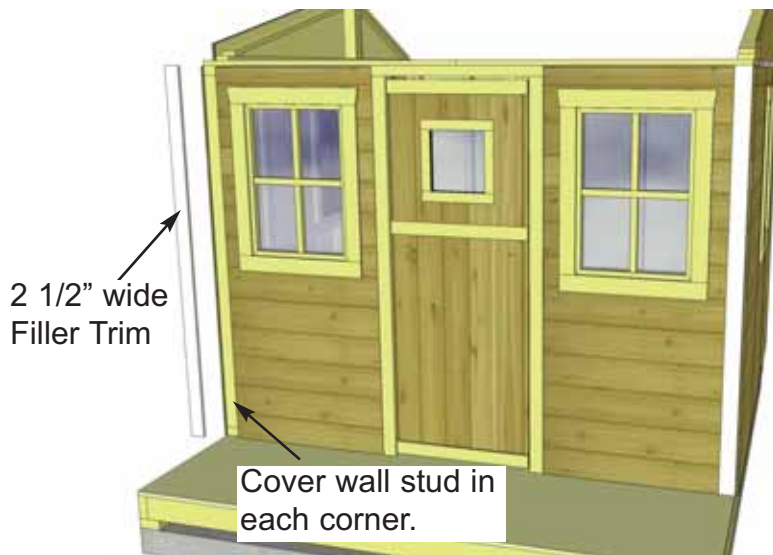

23. Position **Filler Trims** in corner to cover exposed wall stud. Align flush with floor and attach with 4 - 1 1/2" finishing nails.

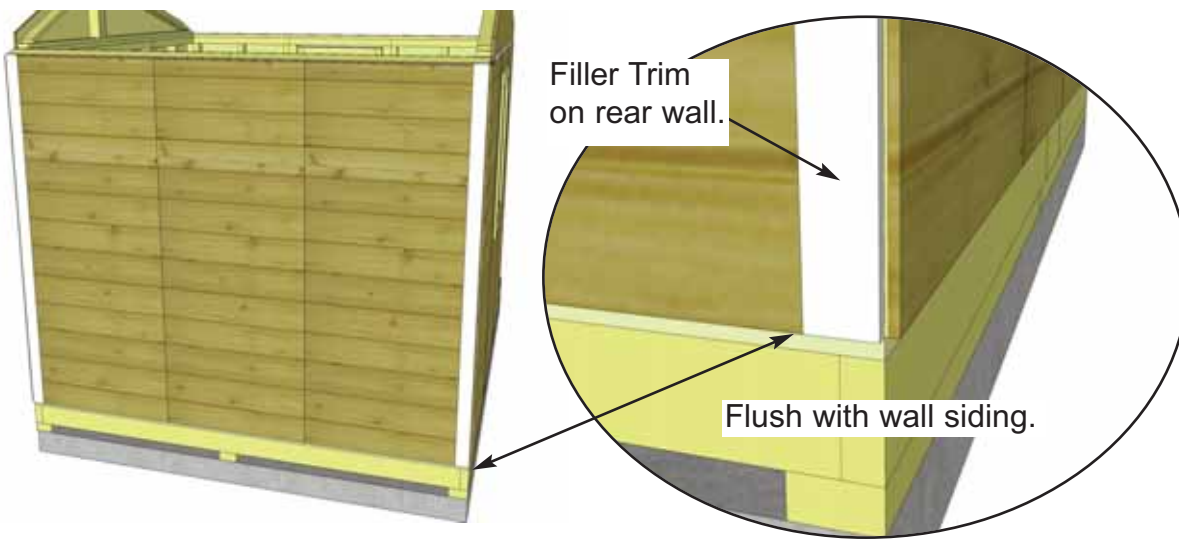

Filler Trim on rear wall.

Flush with wall siding.

24. Position Filler Trim on Rear Wall and attach as per **Step 23.**

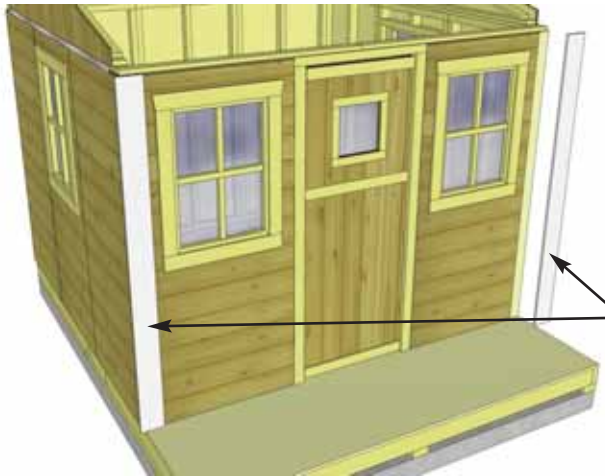

Attach Front Corner Trim prior to Porch Assembly. Use 6 - 1 1/2" finishing nails per piece to secure

Overhang Wide Trim 1/2" past Side Wall Siding. See **Step 58** for correct alignment.

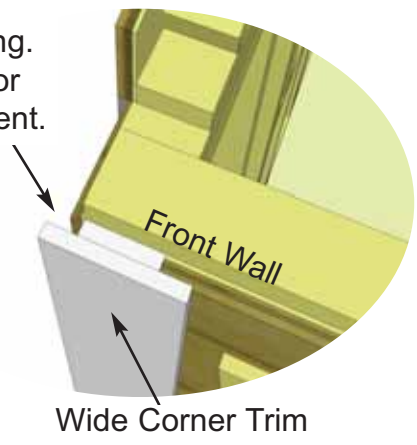

Front Wall
Wide Corner Trim

25. Position and attach both 1/2" x 4 1/2" x 60" **Front Wall Corner Trims** over Filler Trims. Overhang 1/2" past Side Wall Siding. See **Step 58** for correct alignment. Use 6 - 1 1/4" finishing nails.

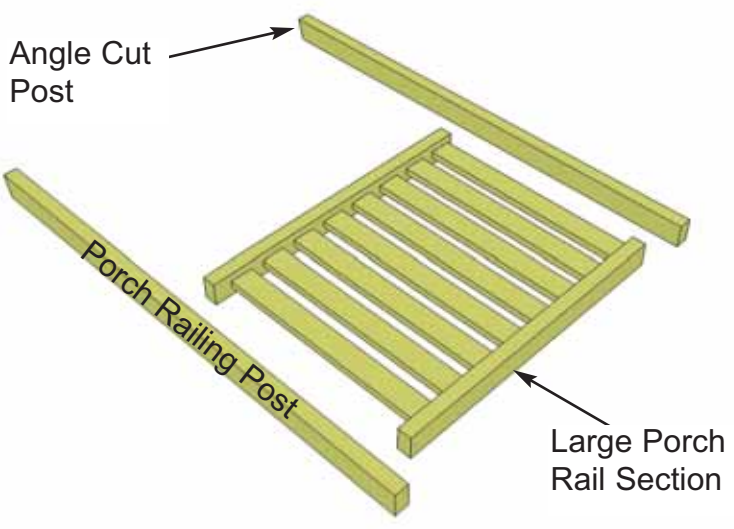

Angle Cut Post

Porch Railing Post

Large Porch Rail Section

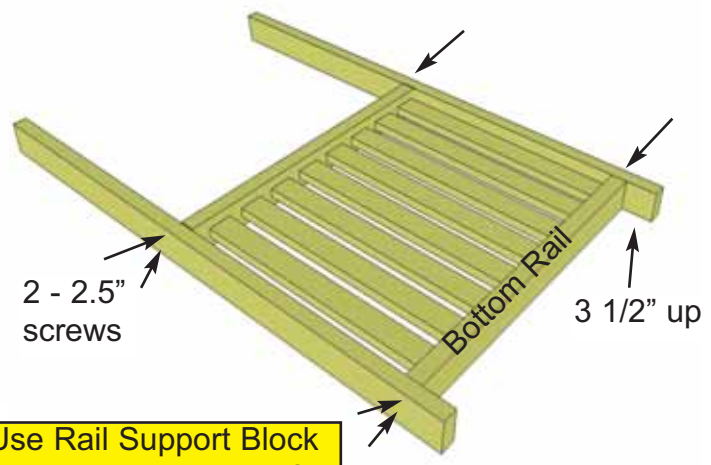

2 - 2.5" screws

Bottom Rail

3 1/2" up

Use Rail Support Block to determine height of Rail. See **Step 68.**

26. Attach **Porch Railing Post** to **Large Porch Rail** sections with 4 - 2 1/2" screws per side. Measure 3 1/2" up from bottom of Porch Post. Use Rail Support Block to determine position of Bottom Rail. **See Step 68.**

27. Complete both Post and Rail sections and lay out on a level surface. Attach the **Porch Post Top Connector** with 2 - 2" screws per post. Drill pilot holes to prevent splitting.

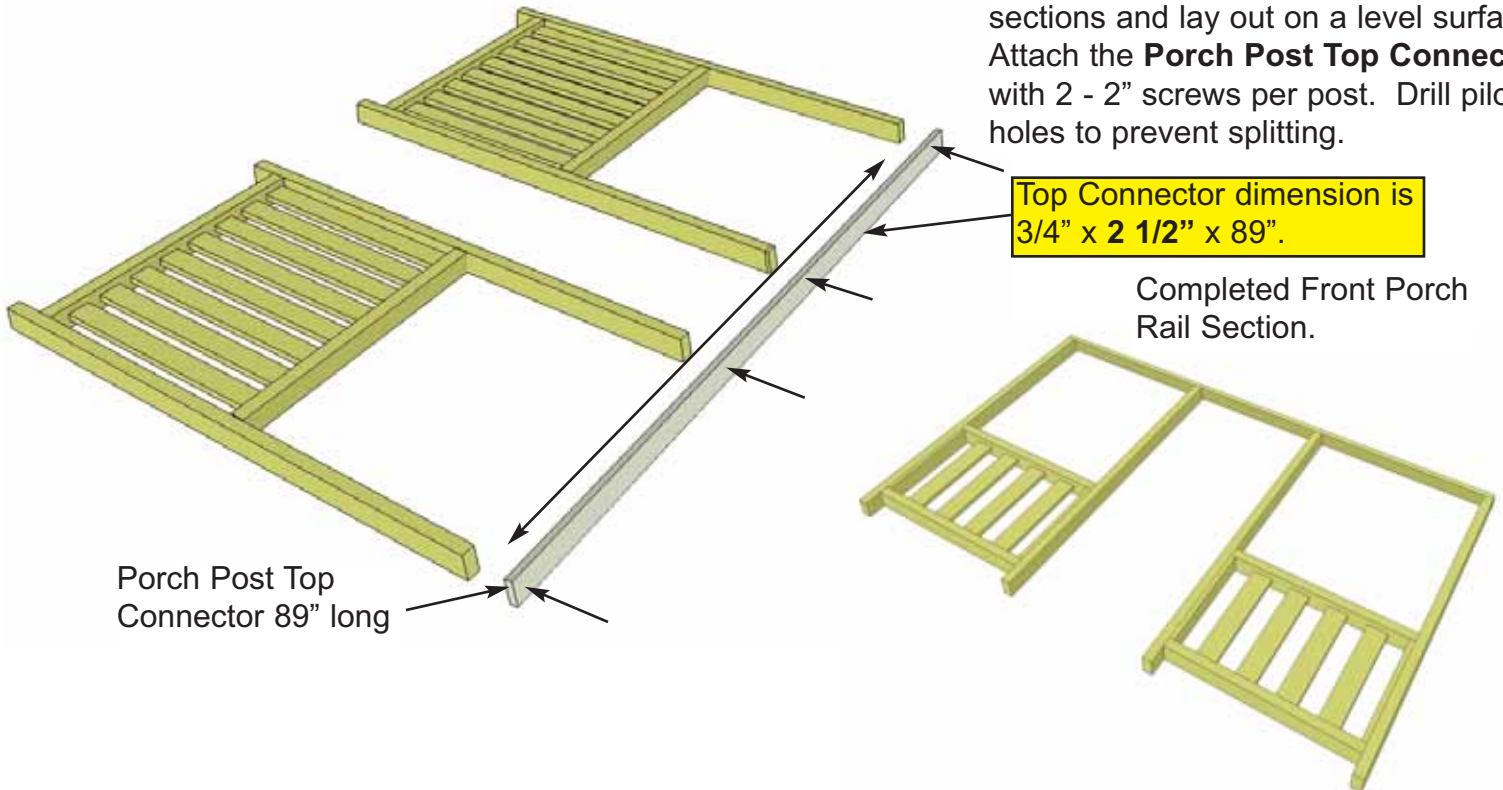

Completed Front Porch Rail Section.

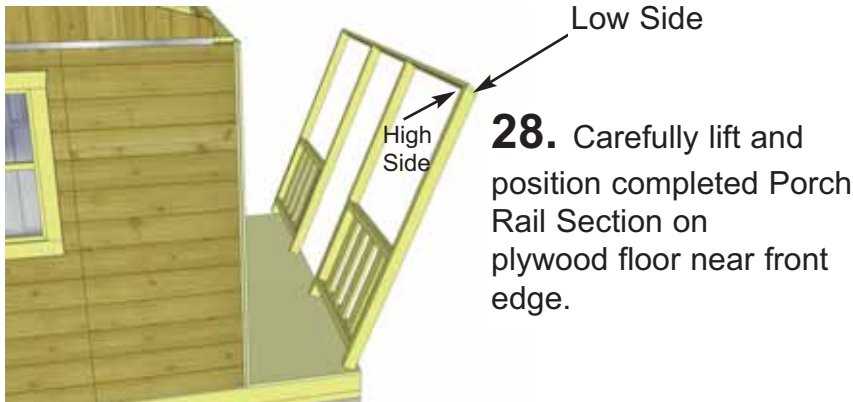

28. Carefully lift and position completed Porch Rail Section on plywood floor near front edge.



Use Rail Support Block to determine height of Rail. See Step 68.

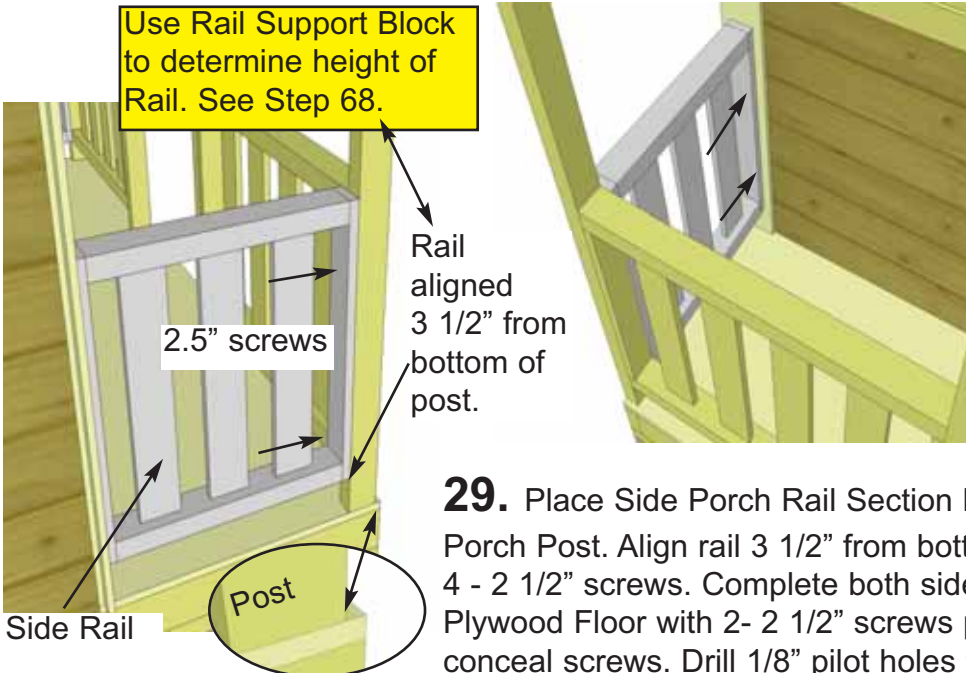

29. Place Side Porch Rail Section between Wide Trim on Playhouse and Porch Post. Align rail 3 1/2" from bottom and secure to wall and post with 4 - 2 1/2" screws. Complete both sides. Angle screw Porch Rail Section to Plywood Floor with 2 - 2 1/2" screws per post. Screw from inside face to conceal screws. Drill 1/8" pilot holes to prevent posts from splitting.

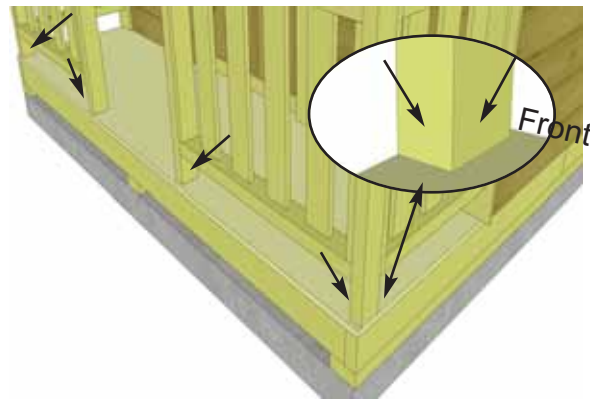

C. Roof Section

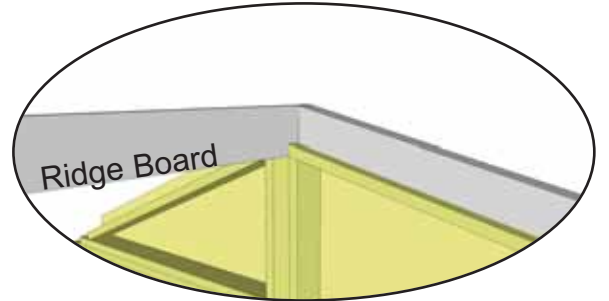
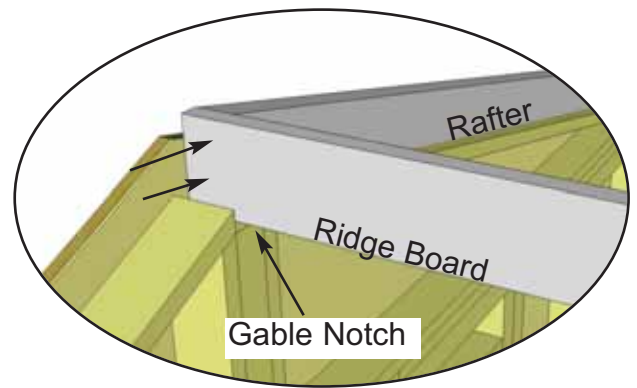
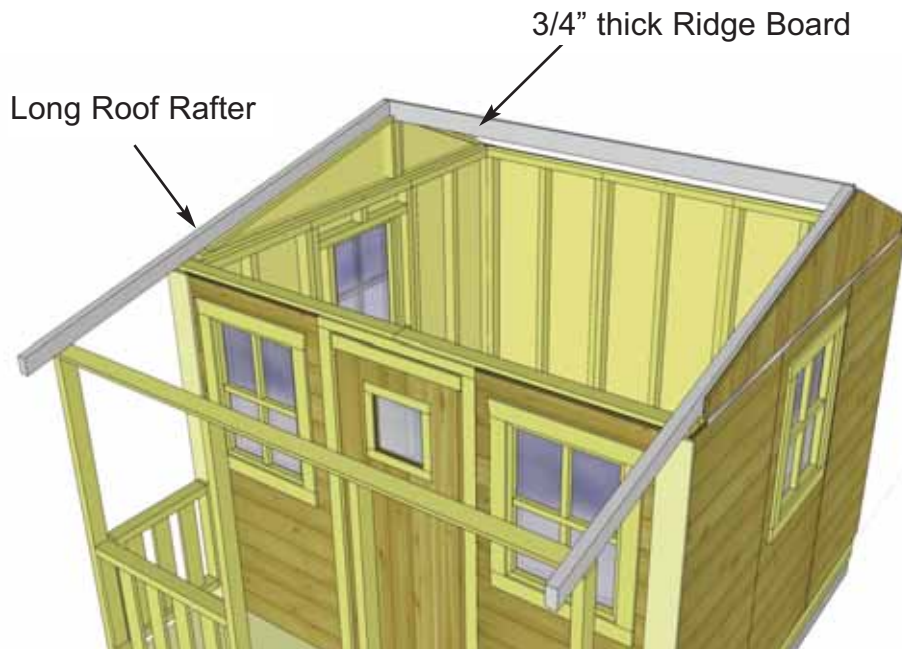

30. Locate one **Ridge Board** - 3/4" x 3 1/2" x 89" and 2 **Long Roof Rafters**. Position Ridge Board in gable notch and Rafter on gable framing. From inside the Playhouse, align Ridge Board and Rafter so they sit even at top and flush to outside of both pieces and attach with 2 - 2" screws. Complete both sides. **Important- Pilot hole Ridge Board with 1/8" drill bit to prevent end of wood from splitting.**

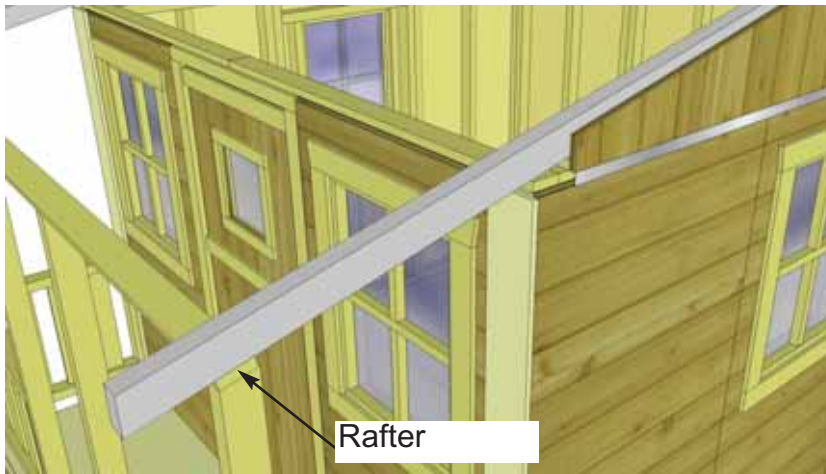

Angle screw Rafter to Porch Rail Section with 1 - 2 1/2" screw.

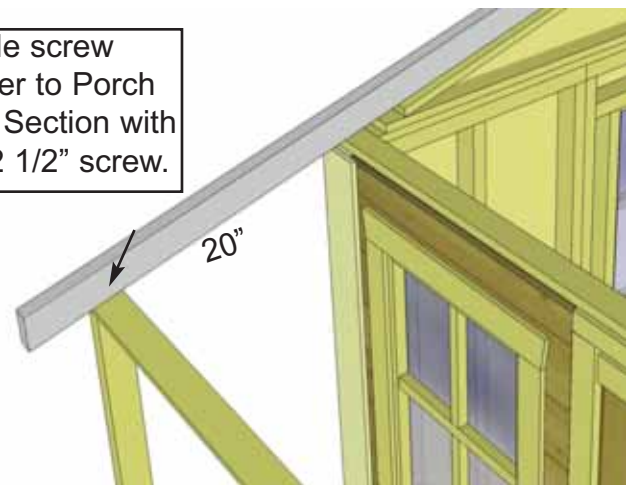

31. To align Rafter in the front, make sure it sits flush to the outside of Porch Rail Section. Check that Patio Railing Post is plumb (20" from Wide Trim). With a 2 1/2" screw, angle screw Rafter to Porch Rail Section. Complete both sides. **Important;** drill pilot holes in rafters prior to attaching.

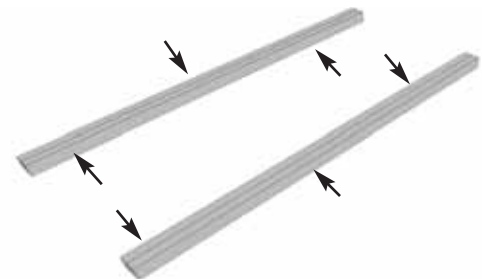
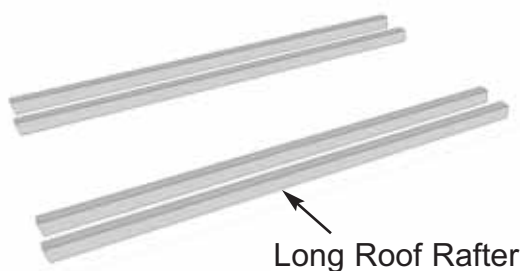

32. Locate remaining Long Roof Rafters (81 1/2" long). Line up 2 pairs evenly and attach together with 3 - 2 1/2" screws.

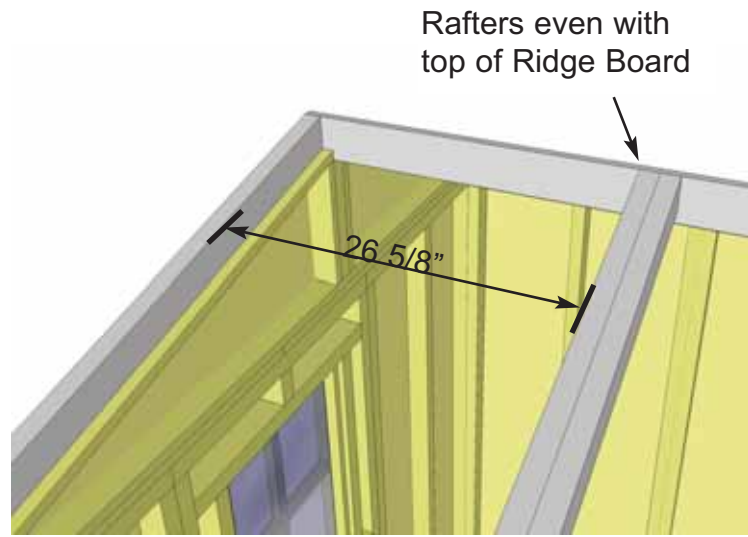

33. Position a pair of Long Roof Rafters 26 5/8" from outer Rafter. Rafters should be aligned even with top of Ridge Board.

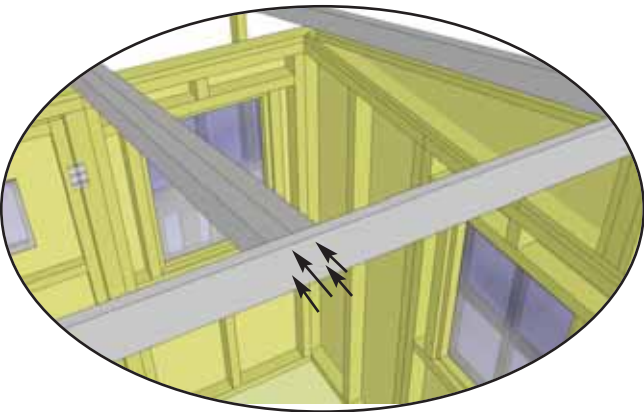

34. Attach Rafters to Ridge Board with 4 - 2" screws.

Position and attach remaining Long Roof Rafters in place as previously illustrated.

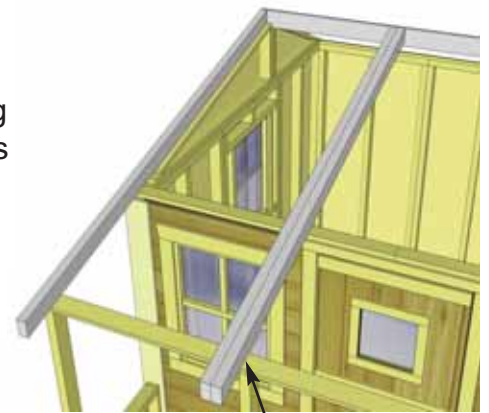

Do not attach Rafters to Porch Rail Section until **Step 42.**

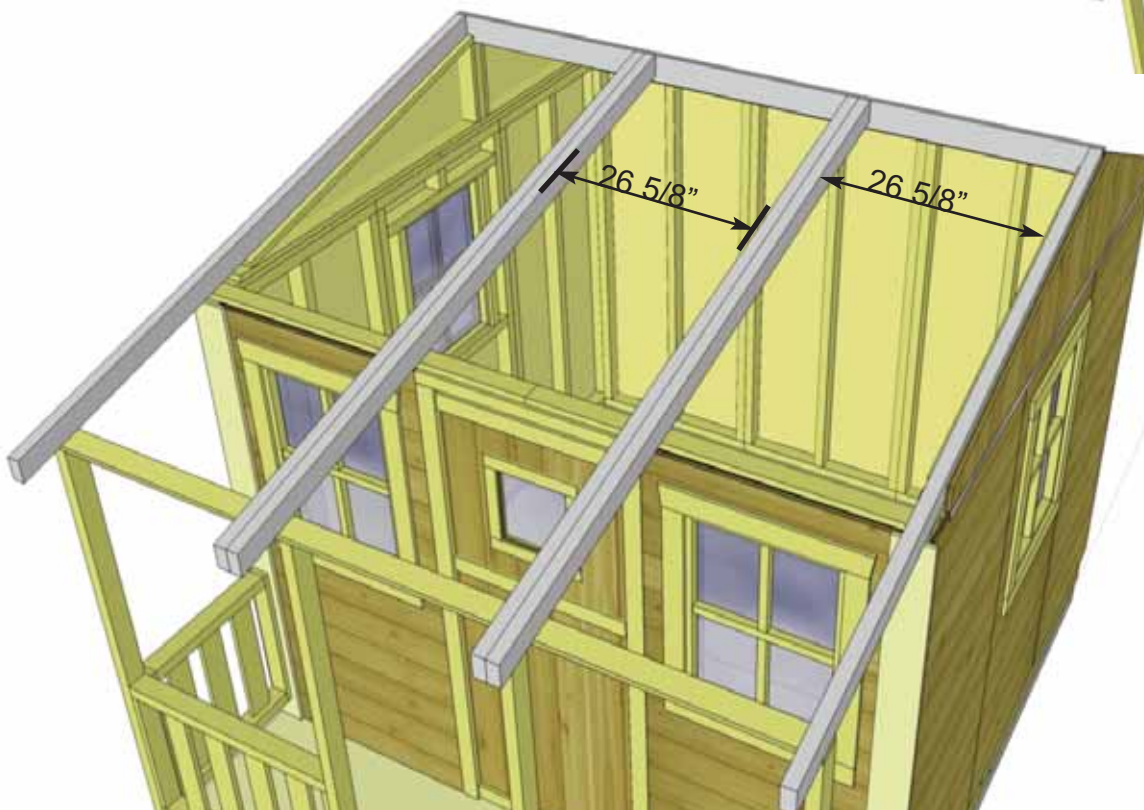

35. Locate 6 **Short Roof Rafters**, 2 **Soffits** and remaining **Ridge Board**. Lay out on level ground as shown to the right. Double up Rafters as illustrated. Screw doubled up Rafters together with 3 - 2 1/2" screws per piece.

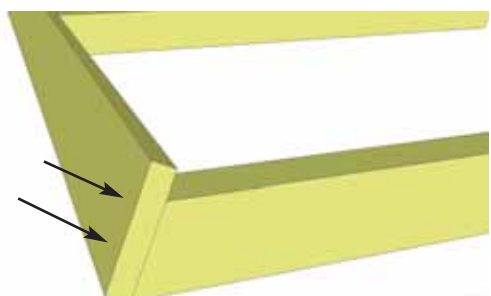
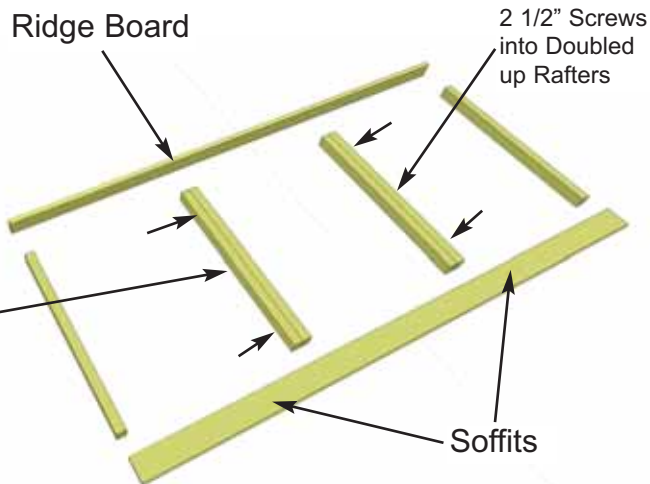

2 1/2" Screws into Doubled up Rafters

36. Attach Ridge Board to ends of both outside rafters with 2 - 2" screws per end. Measure and position interior Rafters as illustrated below. When positioned correctly, attach Ridge Board to remaining rafters with 2 - 2" screws /rafter end.

Important:
Pilot Hole Ridge Board to prevent splitting!

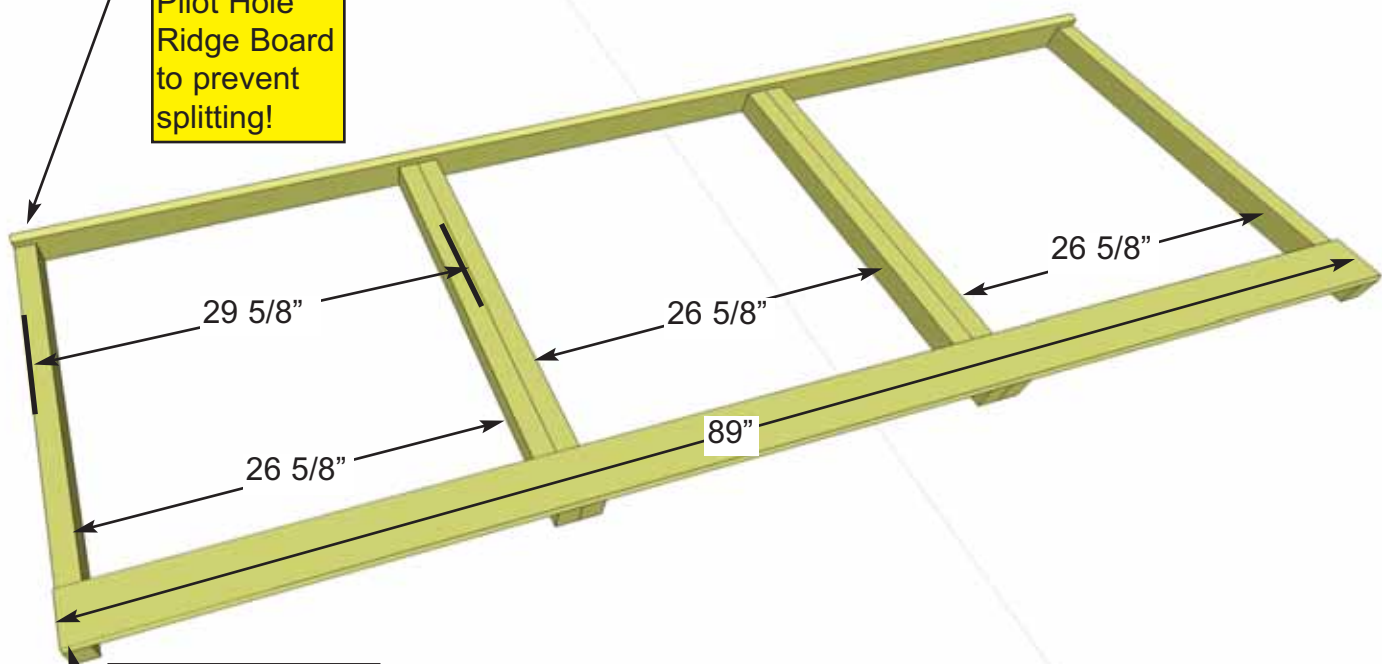

Important:
Pilot Hole Soffit to prevent splitting!

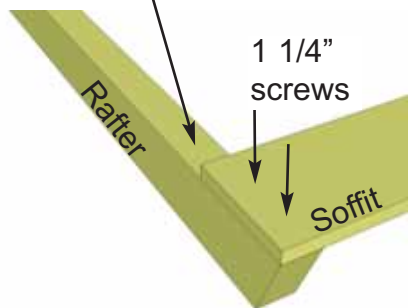

1 1/4" screws

37. Attach end of a 89" long Soffit Board flush to ends of outside rafters with 2 - 1 1/4" screws per rafter end. Drill pilot hole in Soffit ends to prevent splitting. Complete both outside rafter / Soffit connections first. Measure and position interior Rafters as illustrated above. When positioned correctly, attach Soffits to remaining rafters with 2 - 1 1/4" screws /rafter. Flip completed rafter section over.

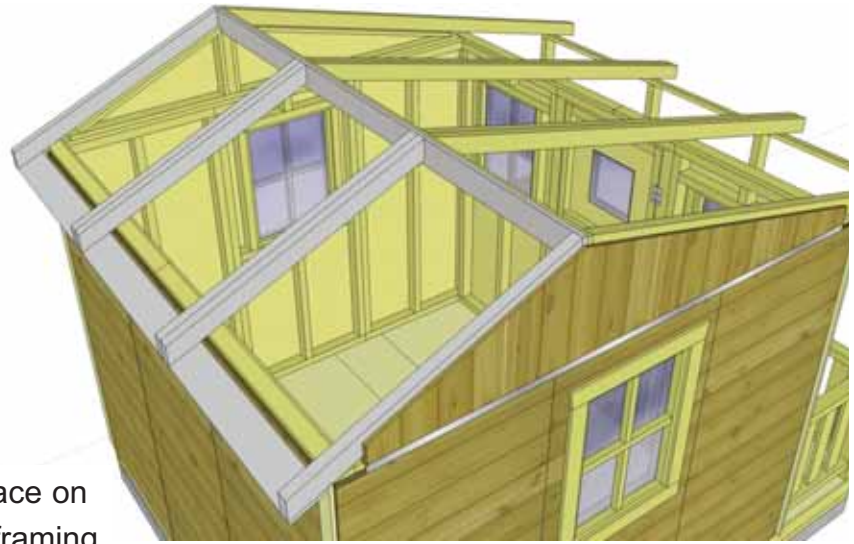
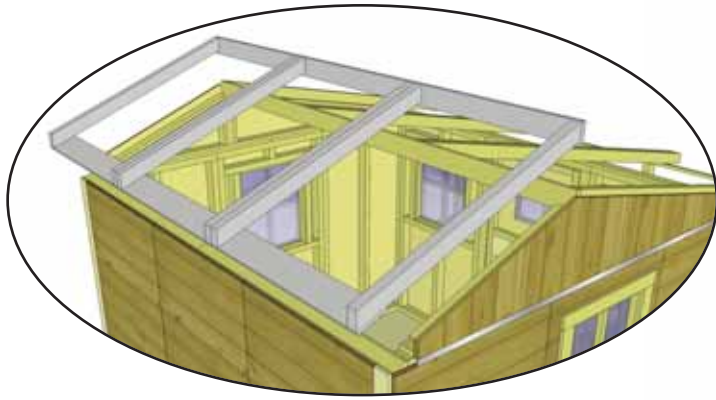

38. Lift up the Short Roof Rafter Section and place on Gable Framing. Slide Rafter Section up on gable framing until bottom of Ridge Board slips into gable notch.

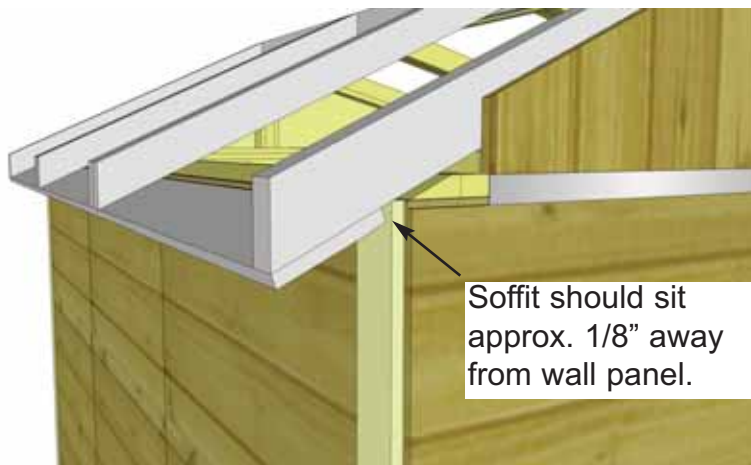

39. When Rafter Section is correctly positioned, outside rafters will sit equally on gable framing and Soffit will sit approximately 1/8" away from wall panels.

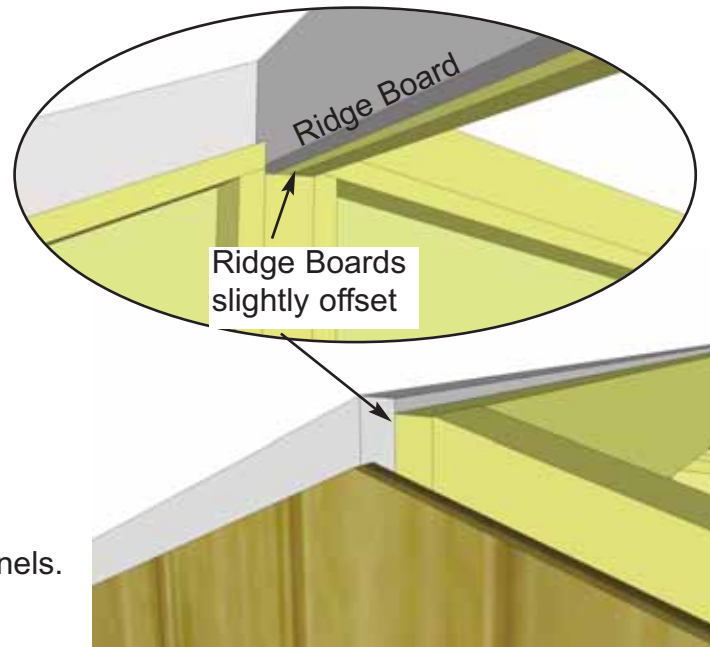

Screw Ridge Boards together with 9 - 1 1/4" screws



40. Attach both Roof Ridge Boards together with 9 - 1 1/4" screws (3 per section).

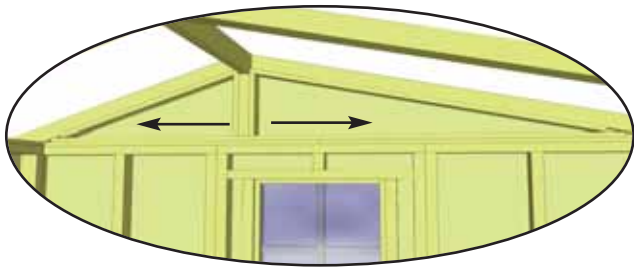

Note- you may have to remove the 2 temporary screws in Gable from Step 21 and reposition Gable for best fit prior to completing gable attachment.

41. With both Ridge Boards attached, completely secure Gable framing to walls and rafters. Use 3 - 2" screws per Rafter. Use an additional 6 - 2" screws to secure Gable to wall.

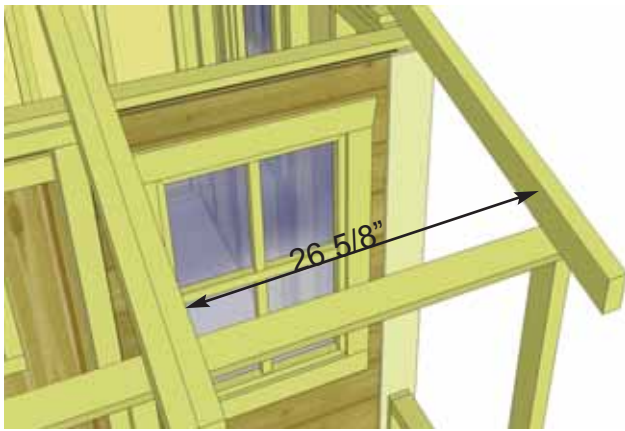
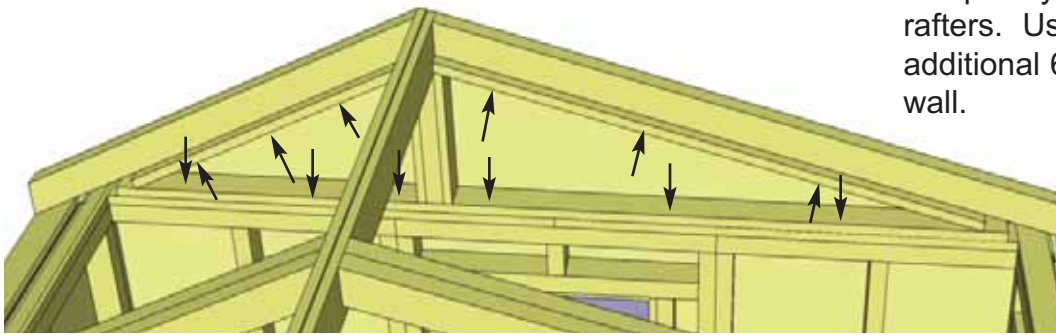

42. Attach doubled-up Long Roof Rafters to Porch Rail Section with 1 - 2" screw per rafter pair. Measure 26 5/8" between rafters and attach from underneath to the Porch Post Top Connector. Complete both rafter pairs.

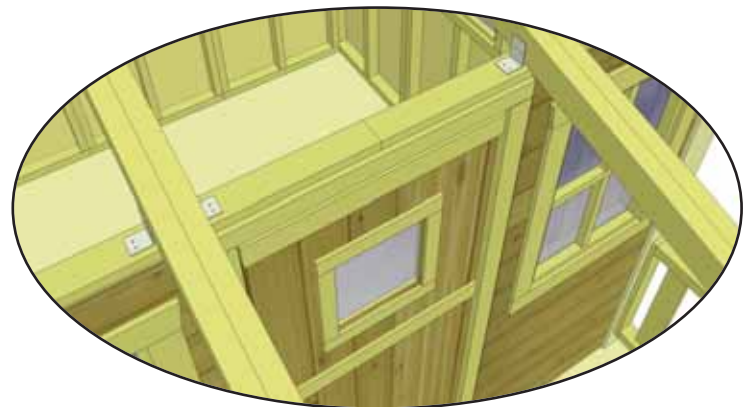
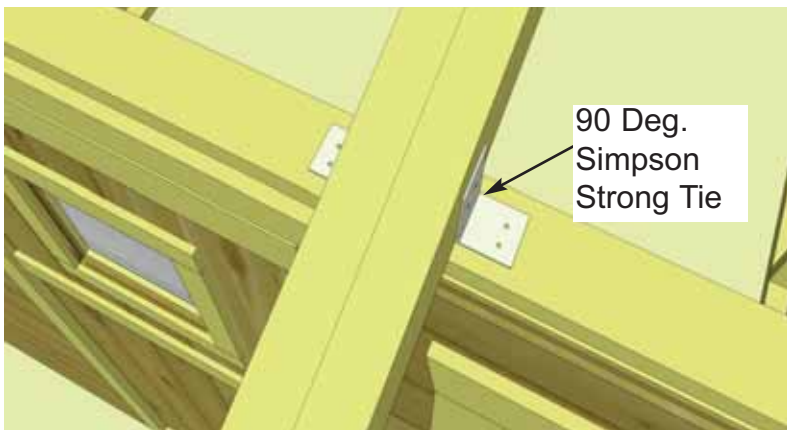

43. To completely secure Rafters to walls, position and attach **Simpson Strong Ties** on the front walls as illustrated above. Use 4 - 1 1/4" screws to secure each Tie. The Front Wall Ties are bent at right angles. Where the rear wall rafters sit on top plate of wall, angle screw 2 - 2 1/2" screws per double up rafter.

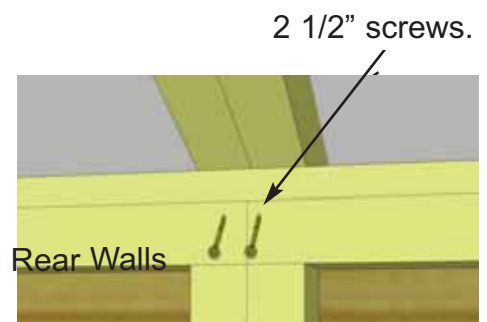

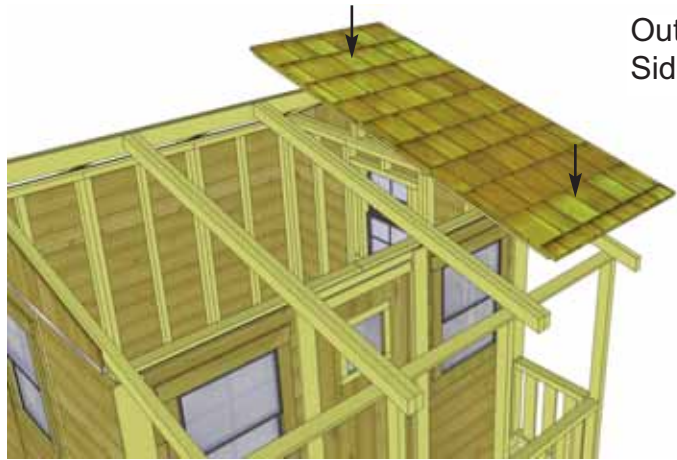

Outside Long Side Roof

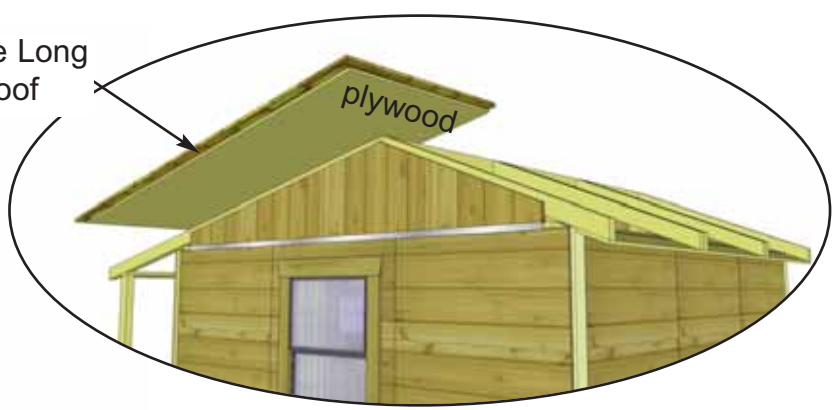

plywood

44. Identify all **Roof Panels**. There are two outside long panels (wider with shingles overhanging plywood sheathing on 1 side) and one long middle panel (plywood flush with shingles). Carefully lift an outside panel up and slide onto roof rafters.



Shingles overhanging plywood

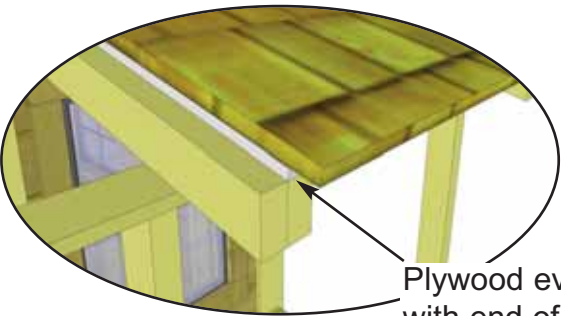

Plywood even with end of Rafter

45. Place Outside Roof Panel so it sits flush on 2nd rafter from the outside (doubled up rafter). Bottom on roof should be flush with end of rafter at bottom. From the outside, screw down through bottom row of shingles into rafter with 1 - 2 1/2" screw. Angle a 2 1/2" screw from outside rafter into roof plywood.



2 1/2" Screw in 1st Row of Shingles Only!

Angle screw from outside rafter into roof plywood

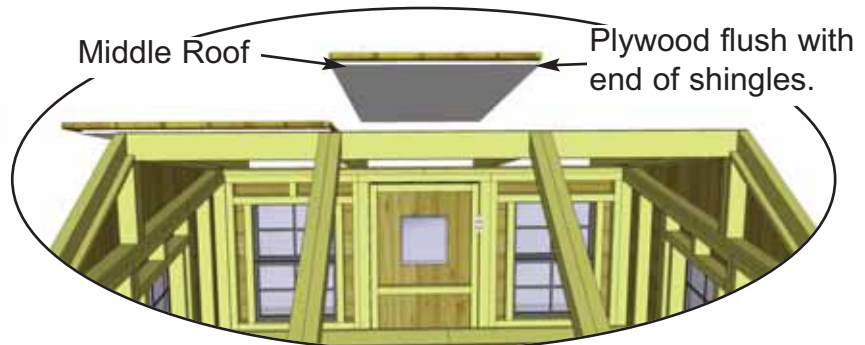
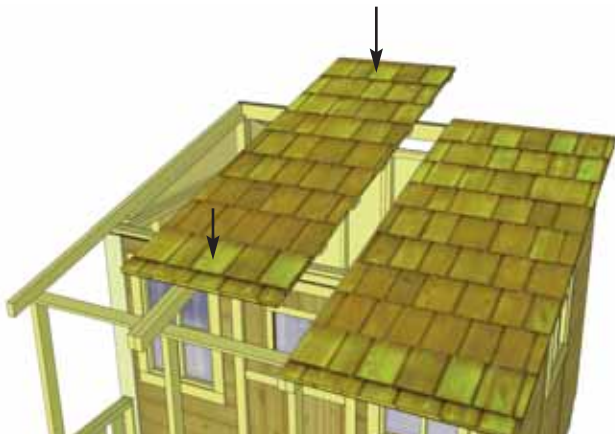
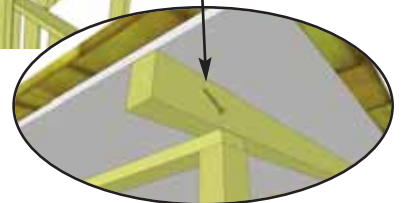

Middle Roof

Plywood flush with end of shingles.

46. Locate Middle Roof Panel.(plywood flush with outside of shingles) and place on middle rafters. Aligned panel as per **Step 44-45** and screw panel down to rafters with 2 - 2 1/2" screws in the bottom row of shingles only.

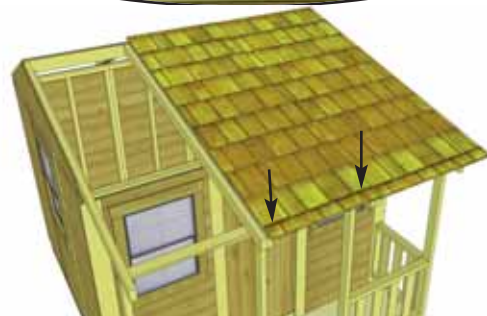

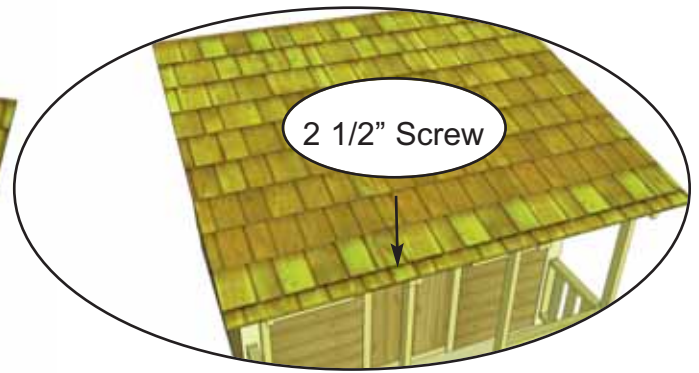
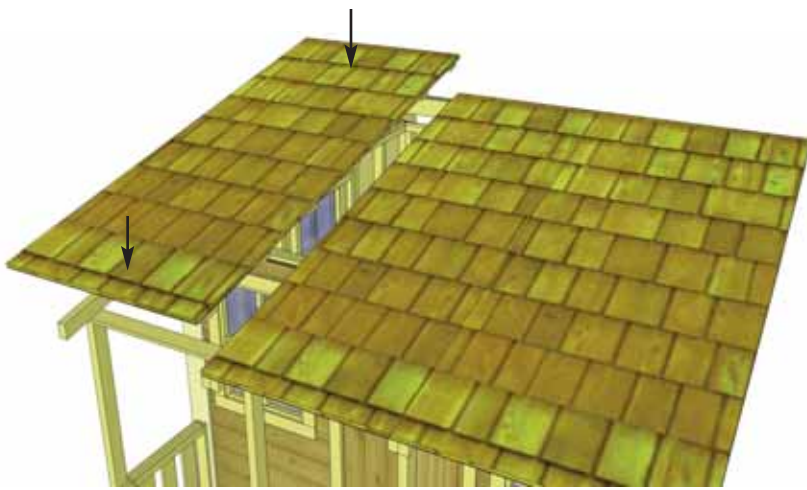

47. Lift up, position and attach 2nd Outside Long Roof Panel on Rafters as per **Step 44-45.**

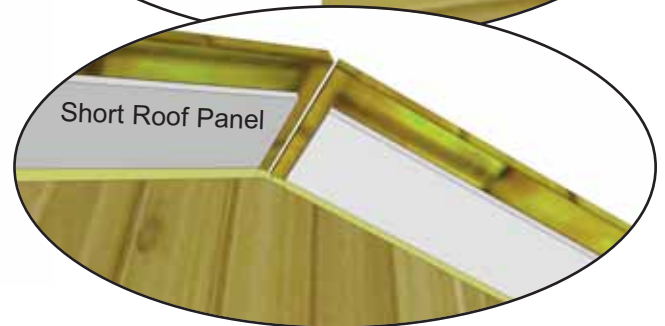
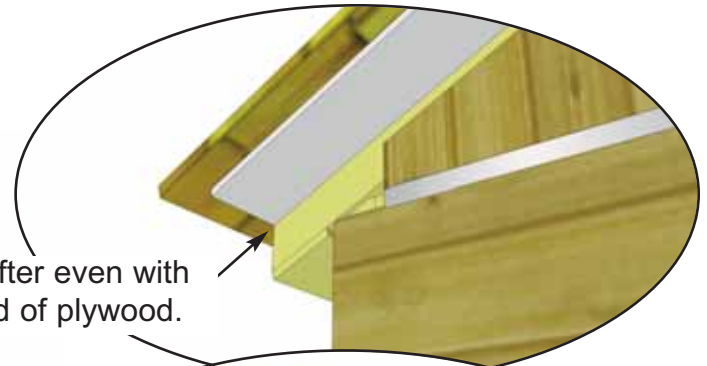
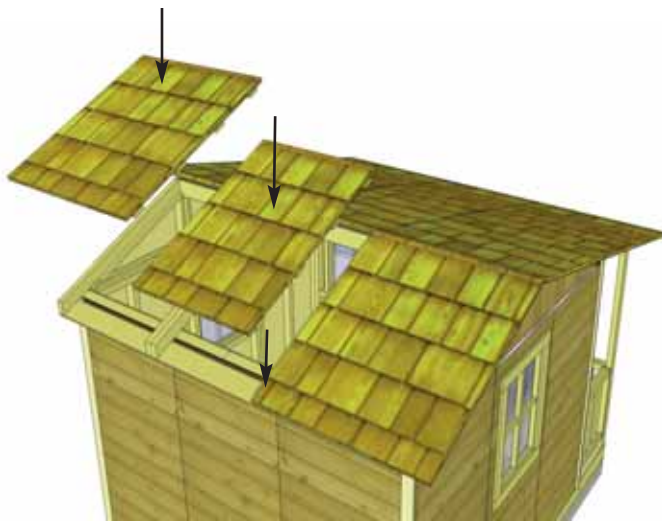

48. Locate **Short Roof Panels** and starting with an outside roof, position and attach as per **Steps 44-45.**

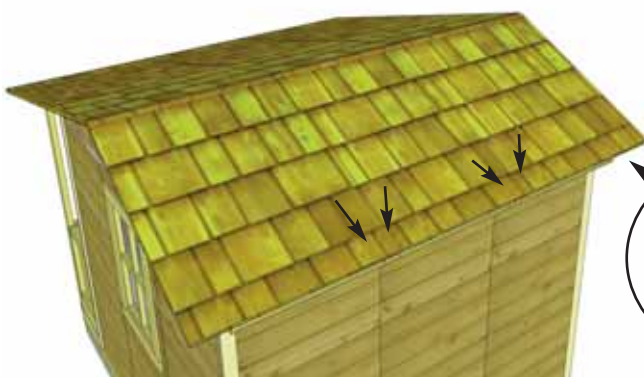

Angle screw from outside rafter into roof plywood.

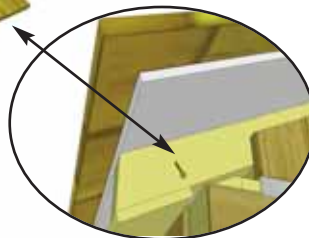

49. Complete attachments of remaining Short Roof Panels. Angle a 2 1/2" screw from outside rafter into roof plywood. Position Center Roof Panel both doubled up rafters.

50. Roof **Filler Shingles** are included to cover roof seams. Starting at the bottom, slide the first long shingle in until flush with other bottom shingles. **DO NOT ATTACH UNTIL STEP 51.**

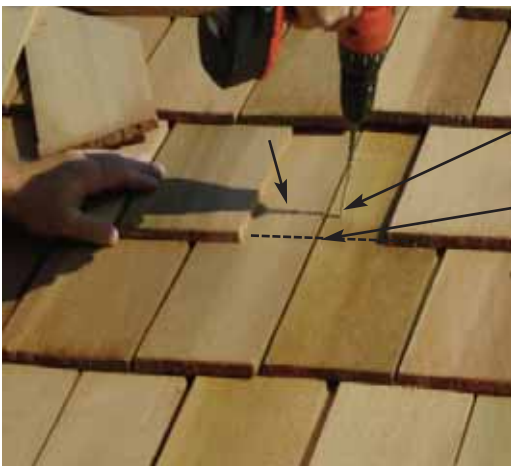

Attach above the exposure line
Exposure Line

51. Screw first filler shingle down to rafters using 1 - 2 1/2" screw per panel (2 in total). Make sure to screw into both rafters.



52. Slide in the next long filler shingle and attach as per **Step 51**. At the top on Long Roof Panels, use smaller shingles to fit (6 3/4" long). Attach final shingles to roof with 2 - 1 1/4" shingle nails per shingle.

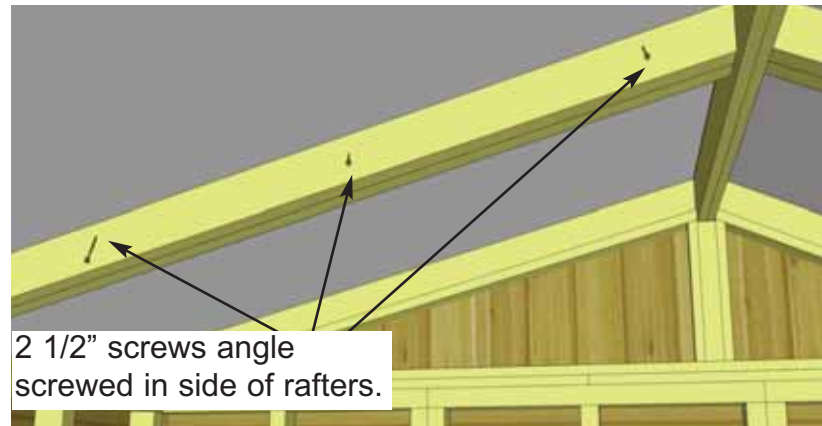
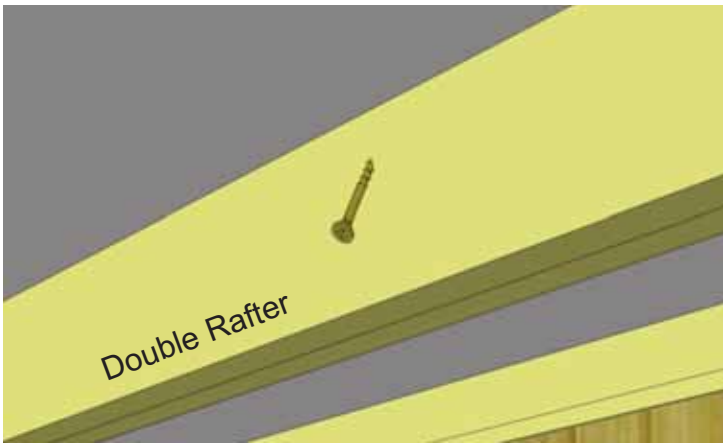

2 1/2" screws angle screwed in side of rafters.

53. To further secure roof panels, from the inside, drill 1/8" pilot holes in each side of doubled-up rafter pairs on an angle into roof plywood. (3 per rafter on the long roof side / 2 per rafter on the short roof side). Using 2 1/2" screws, secure rafters to plywood. **Note**, from outside, push roof panel down so roof sits flush against rafter when securing. **Important - Position screw on angle so it catches the rafter and plywood (1/2" thickness but does not go through roof shingles).**

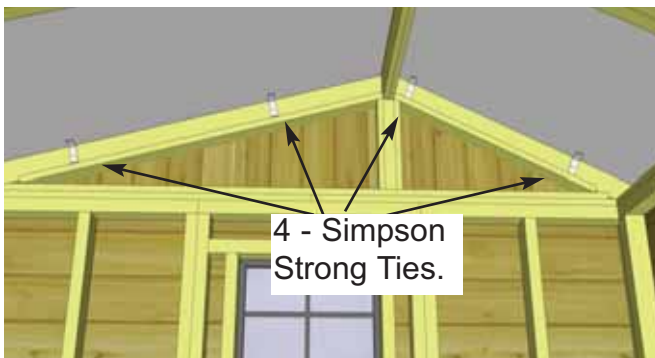

4 - Simpson Strong Ties.

54. Position 4 Simpson Strong ties on plywood roof and outside rafters and secure 4 - 1 1/4" screws. Complete both sides. 8 Ties in total.



55. From the inside, position and attach the 3 **Front Soffits** to top of wall framing with 3 - 1 1/4" screws per piece. Move Soffit vertically up until gap is closed at roof. Drill pilot holes first to prevent Soffits from splitting.

D. Miscellaneous Section

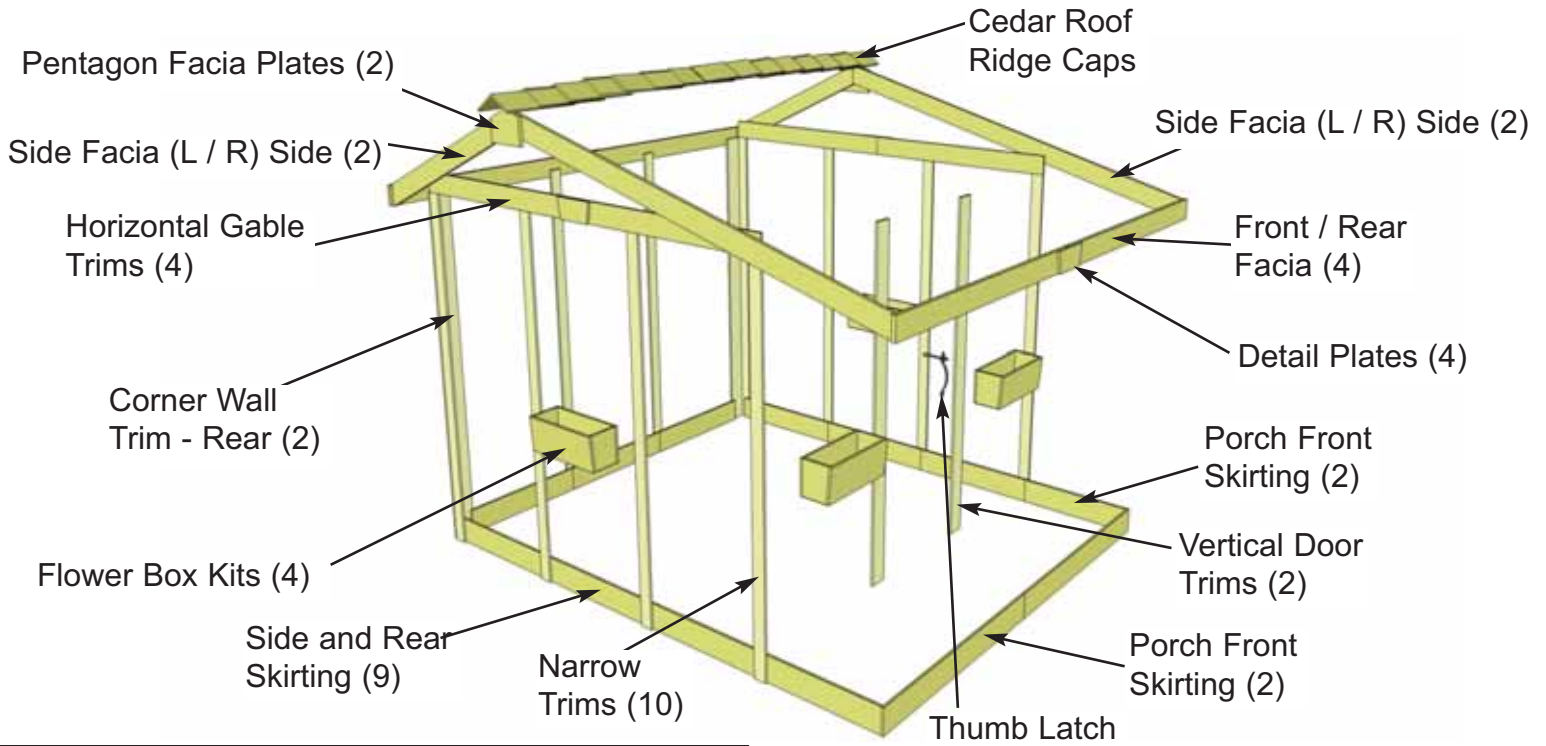

Expert Advise-
 When installing trim, sort pieces according to color and pieces that are most pleasing to the eye. Start with least visible side and use the least desirable pieces first. Install trim to most visible sides as your skill installing trim improves.

1/2" overhang

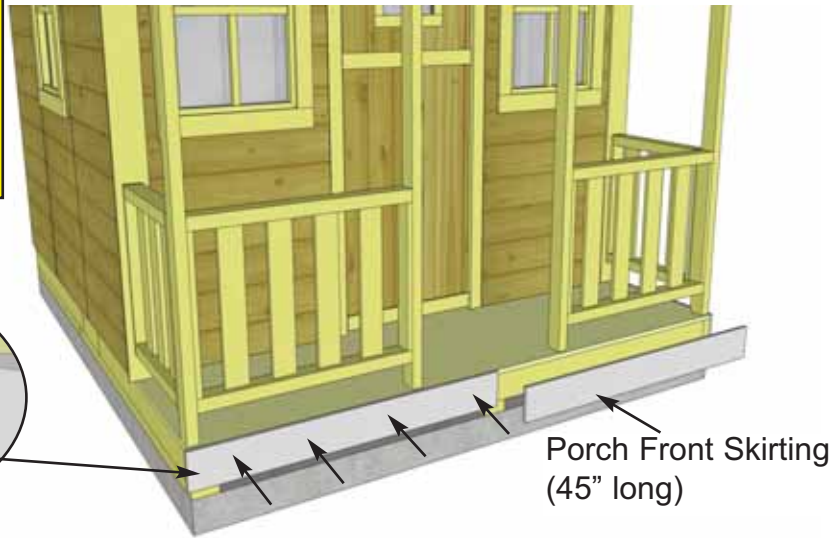
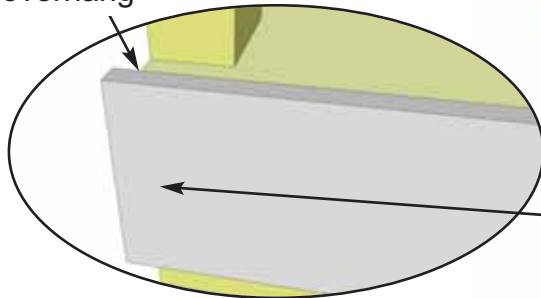

Note: All Trim, Facia and Bottom Skirting pieces will be positioned rough face out when installed.

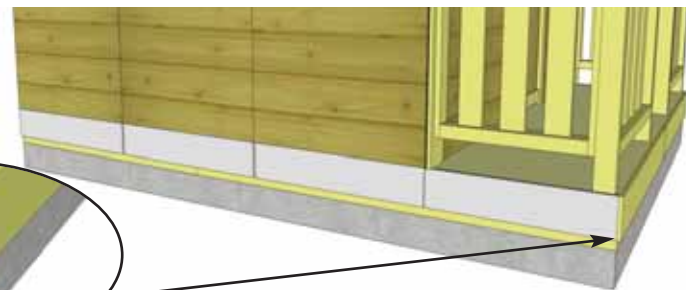
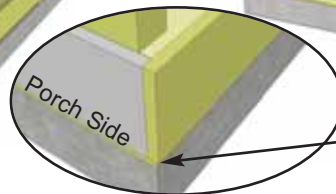
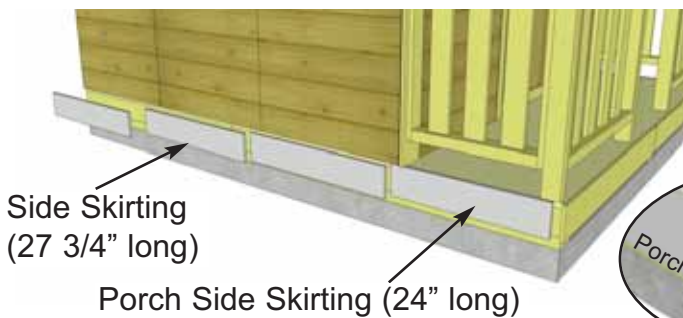

56. Attach **Bottom Skirting** around the base of the playhouse. Skirting will hide floor framing. Starting with **Porch Front Skirting**, position so it overhangs plywood floor by 1/2" in the front corner. Secure with 4 - 1 1/2" finishing nails. Complete both sides. Position and attach **Porch Side Skirting** with 3 - 1 1/2" nails. Position and attach **Side Skirting** evenly with wall siding. Attach with 3 - 1 1/2" nails per piece.

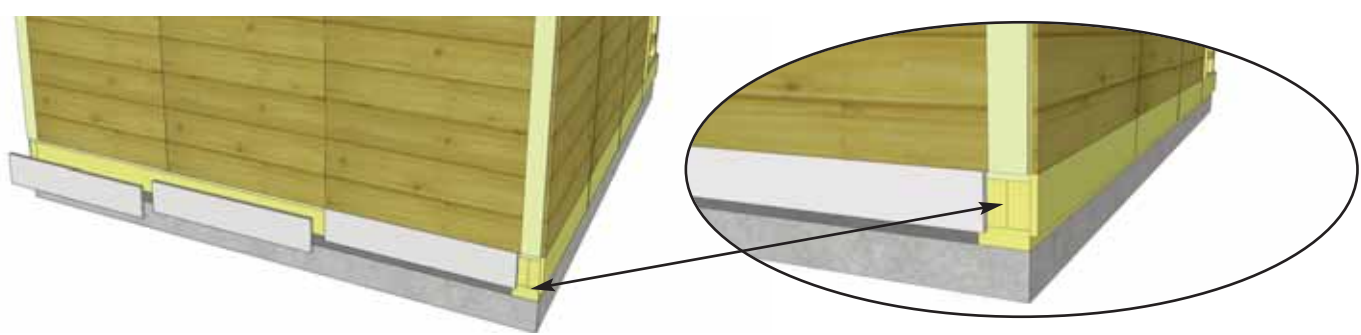

57. Attach **Rear Skirting** as per **Step 56**. Gaps will occur in rear corners that will be covered in **Step 58**.

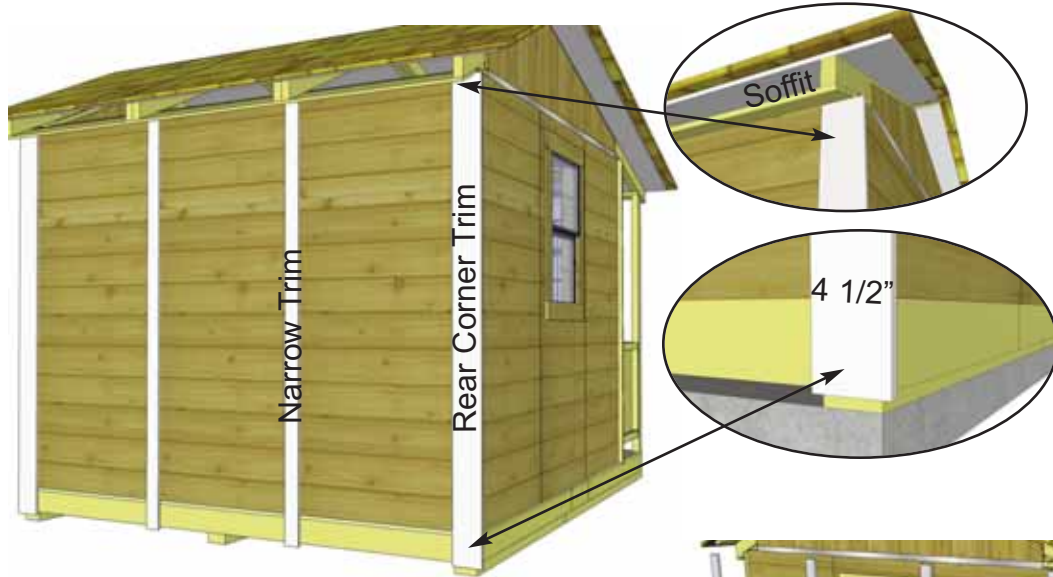

58. Position and attach **Rear Wide Corner Trims** first. Align tight to Soffit and to cap side **Narrow Trim** as illustrated below. Do a dry run to confirm position. Attach with 6 - 1 1/2" finishing nails per piece. Complete all side and rear wall **Narrow Trims** making sure to align trims at same vertical location. **Narrow Trims** will cover wall seams. Use Flower Box width to determine side **Narrow Wall Trim** locations. Refer to **Step 69**.

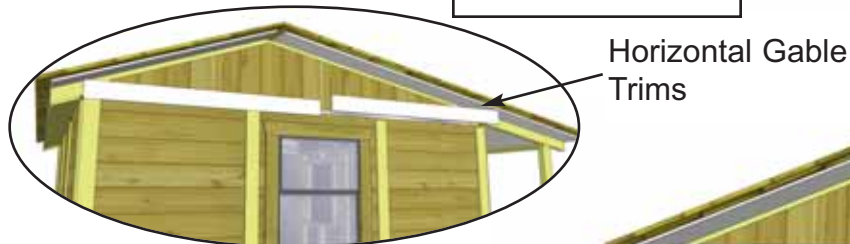
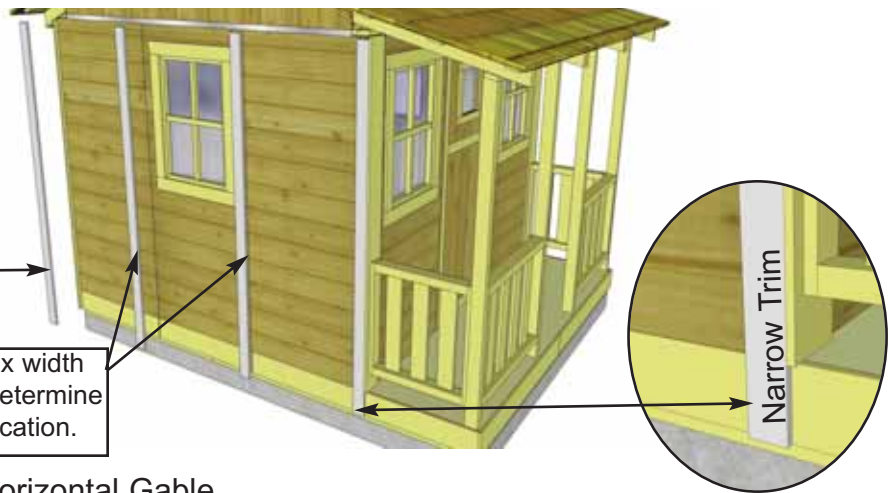
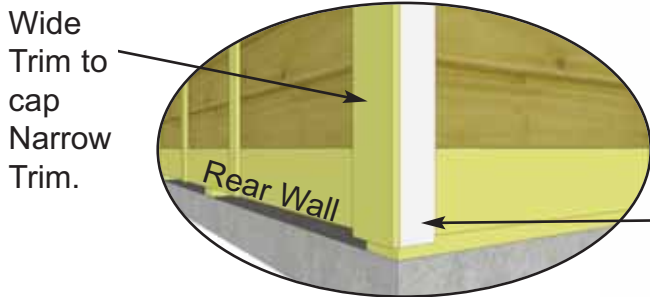

59. Attach **Horizontal Gable Trim** (4 - 1/2" x 3 1/2" x 42 1/2") to both sides. Position over gable and wall seam. Use 4 - 1 1/2" finishing nails to secure each piece. Make sure gable trims covers flashing completely. Cover Gable Trim seam with **Detail Plate**. Attach with 4 - 1 1/2" finishing nails per piece.

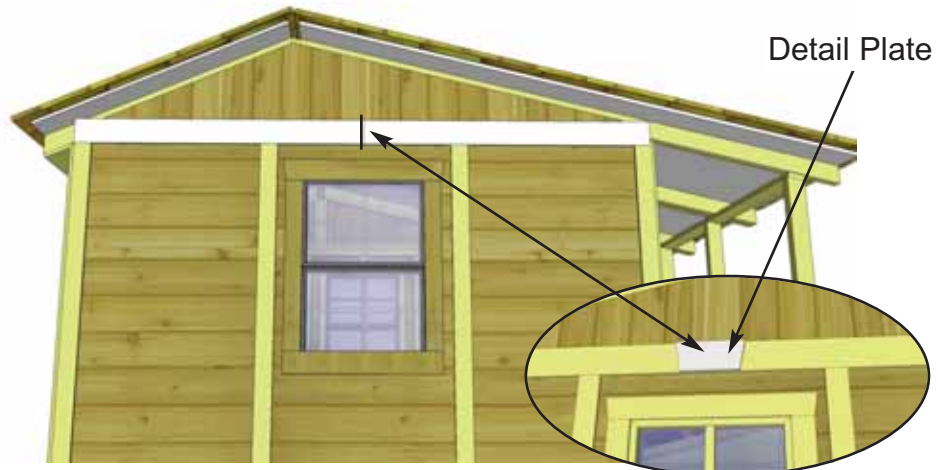

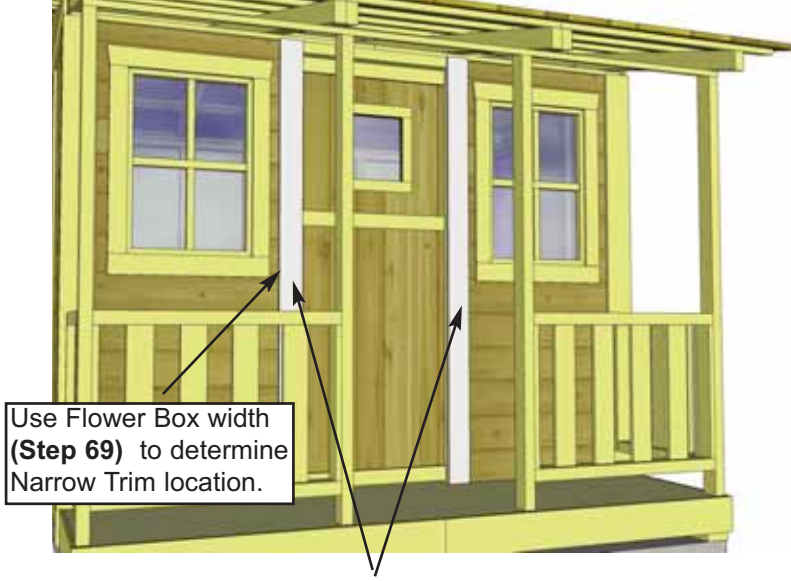

Vertical Door Trim

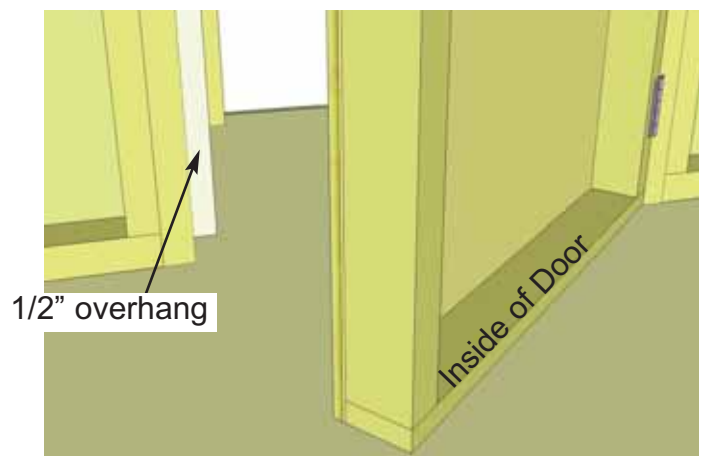

1/2" overhang

Inside of Door

60. Position both **Vertical Door Trims** (3 1/2" wide) to cover doorway gap. Align trims so there is approximately a 1/2" overhang past door to act as a Door Stop. Use Flower Box width to determine Door Trim locations. Refer to **Step 69**. Attach with 4 - 1 1/4" screws per piece.



36" long

72" long



flush to edge of plywood.

61. Attach **Roof/Facia Nailing Strip** - 3/4" x 1 1/2" x 36" and 72" onto outside of each outside roof panel flush with plywood. Attach with 4 - 1 1/4" **Screws** evenly spaced. Complete both sides. The strip provides for a greater nailing surface in **Step 62**.

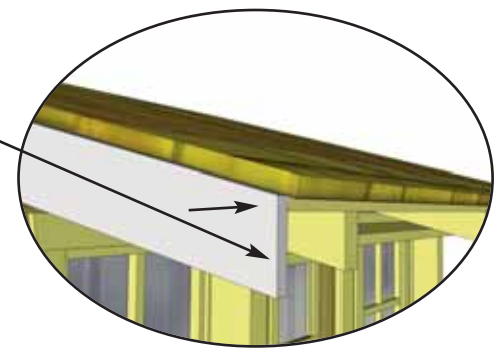
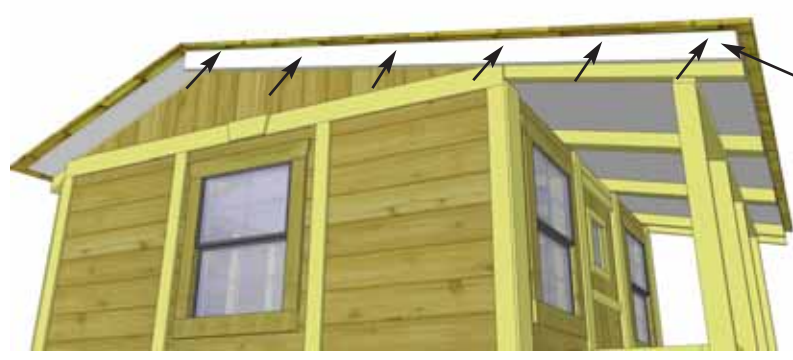

62. Attach **Side Facia** - (angle cut on ends) to end roof panel battens starting long roof side first. End of facia should be aligned flush with end of rafter. See **Step 63** for detail. Attach to batten ends with 6 - 1 1/2" finishing nails per piece. Complete both sides.

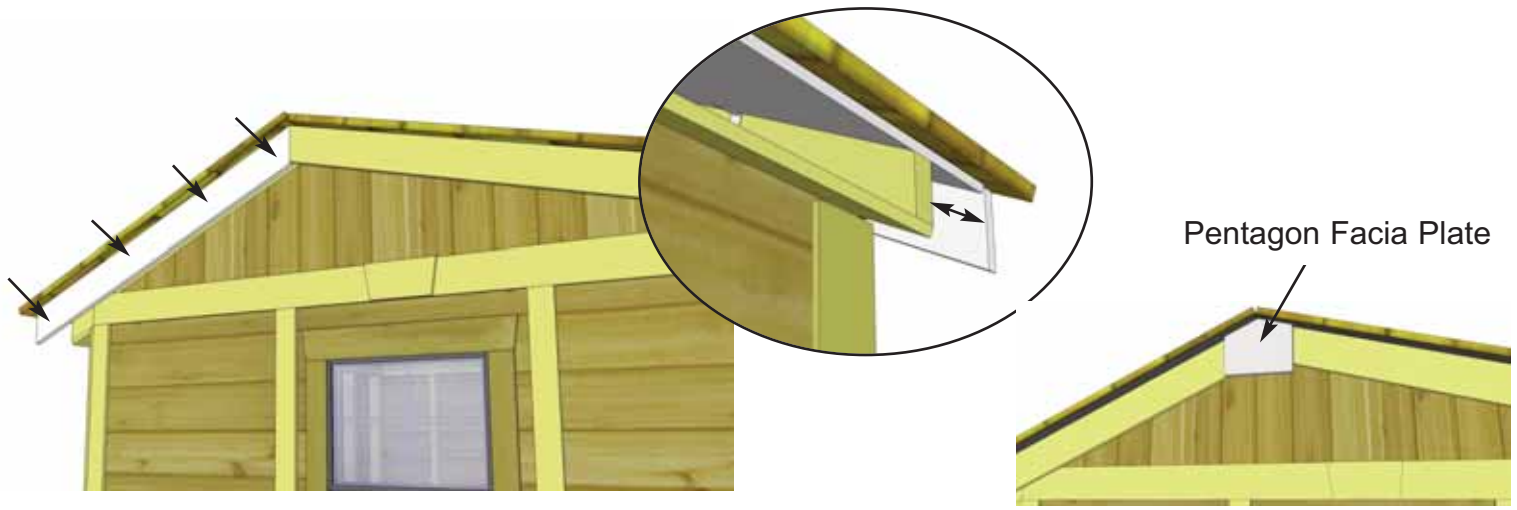

63. Attach Side Facia for short roof side next as per **Step 62**. Gap where facia boards come together at peak will be covered by Pentagon Facia Plate **with 4 - 1 1/2" nails**. Position and attach both **Pentagon Facia Plates** at peak where Side Facia's meet. Attach with 4 - 1 1/2" finishing nails per piece.

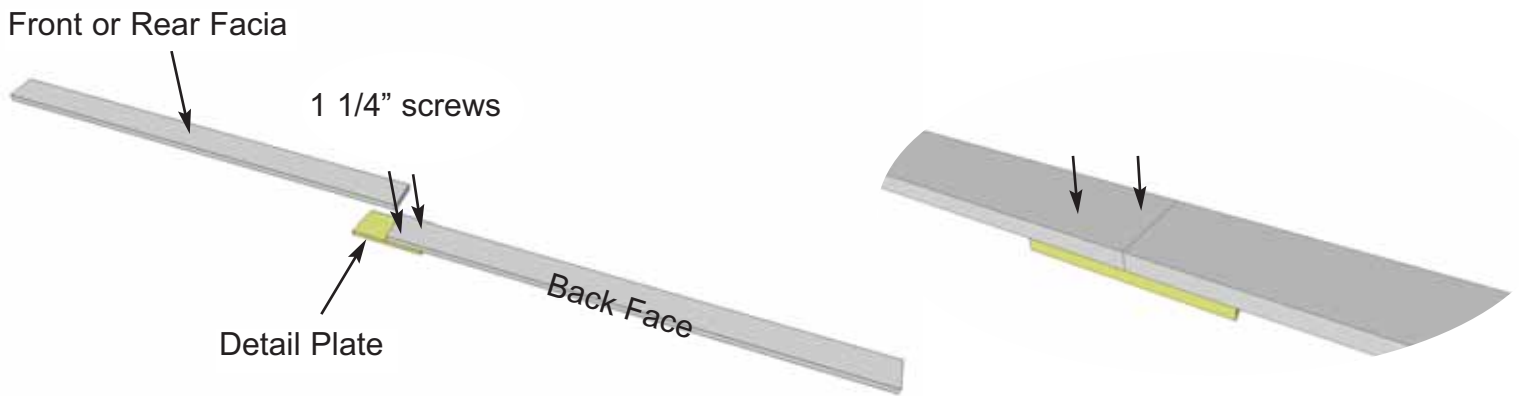

64. On a flat surface, align **Front Facia** on a Detail Plate evenly. Screw together with 2 - 1 1/4" screws per piece. Prior to attaching, match Facia for color and wood grain for best fit. Important- Drill 1/8" pilot holes in Facia ends to prevent wood from splitting. Complete both Front and Rear Facia pieces.

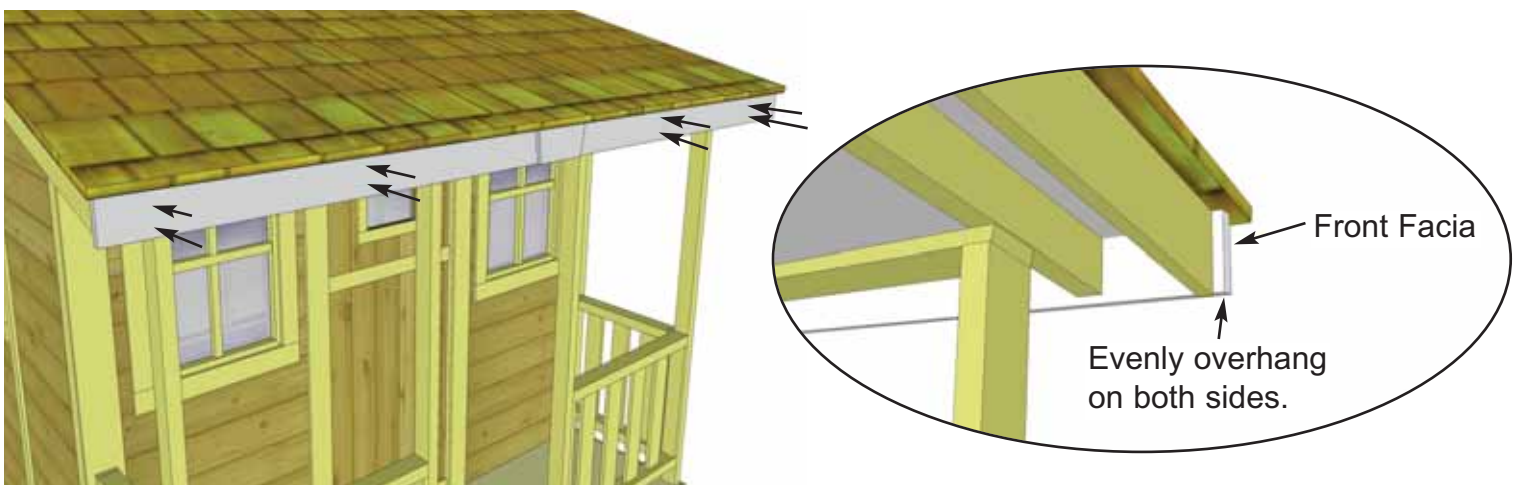

65. Attach **Front and Rear Facia** to roof rafter ends. Position Facia evenly on Side Facia and tight against underside of roof panels. Secure with 8 - 1 1/2" finishing nails per piece.

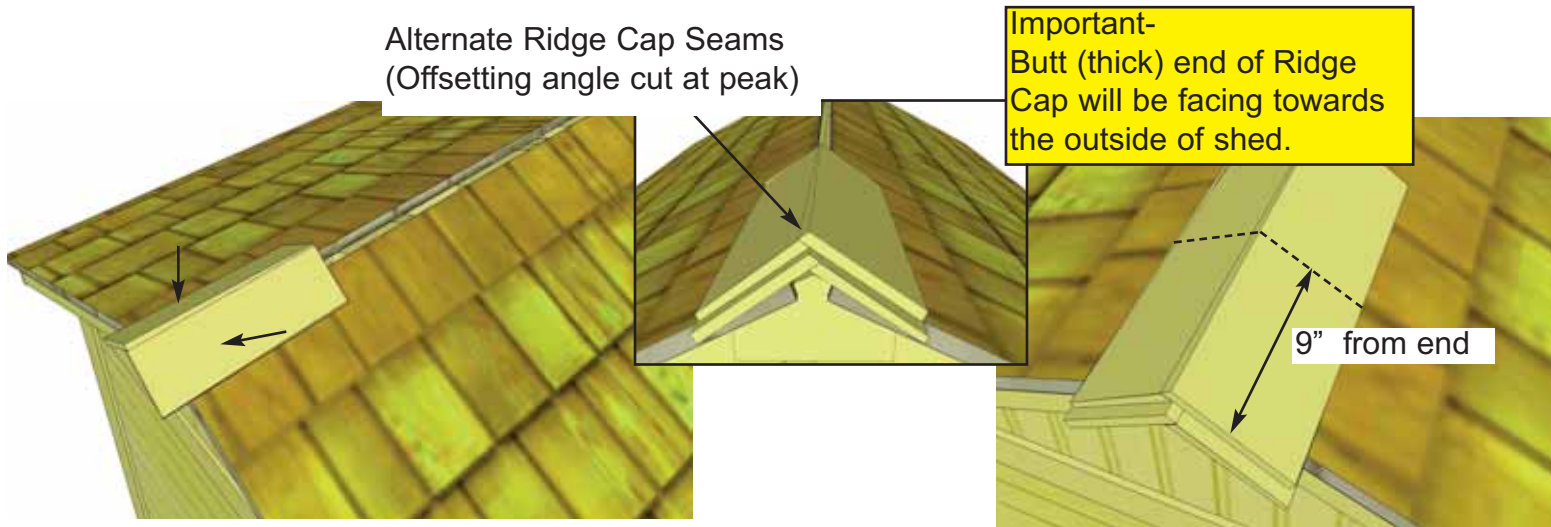

66. Place First **Roof Ridge Cap** on roof peak overhanging shingles by approximately 2". Attach with 2 - 1 1/2" Shingle Nails 9" from end. Place 2nd Ridge Cap 1" back from 1st cap. Attach with 2 - 1 1/4" Shingle Nails 9" from end. There are left/right Ridge Caps, alternate each Ridge Cap as you proceed.

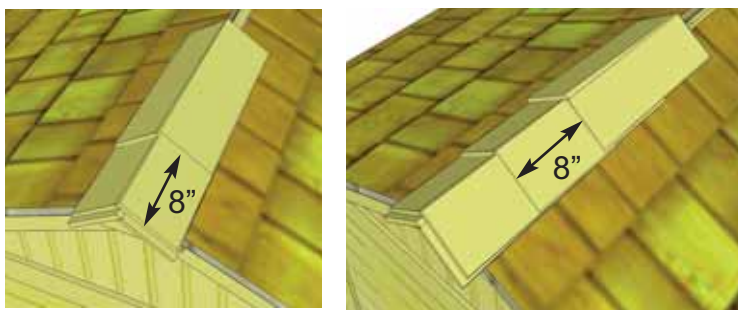

67. Place 3rd Ridge Cap 8" back from 2nd. (enough to cover shingle nails). Attach 3rd Ridge Cap down as per **Step 66**. Continue to position and attach Ridge Caps until half the roof is complete. From opposite side, position and attach Ridge Caps as described above. Score/cut 1 Ridge Cap to 12" or to fit in the center of roof. Attach center cap with 4 - 1 1/2" Shingle Nails.

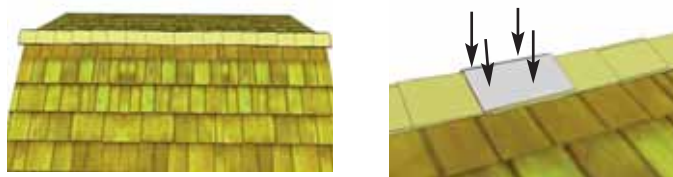

68. Attach **Door Handle** using 3/4" Black Screws.

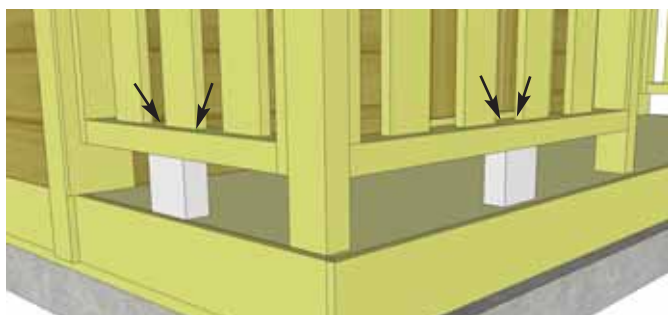

69. Place Rail Support Block (4 - 1 1/2" x 3 1/2" x 3 1/2") centered below each Handrail section. Screw down from the bottom rail into the Block with 2 - 2" screws per piece.

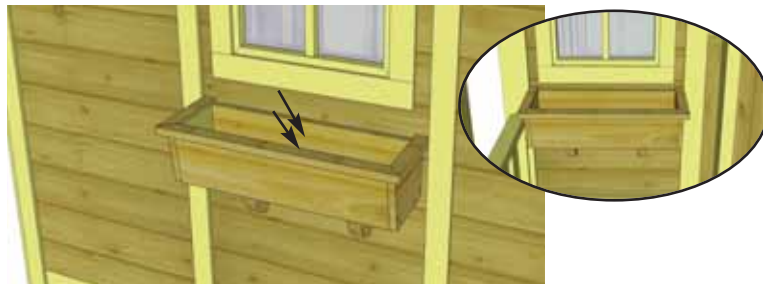

70. Assemble **Flower Box Kit** with Assembly Instructions included. Position completed Flower Box below bottom of window trim and secure with 2 - 2" screws per box. Screw from inside of box into the center wall stud. Attach second screw 2" underneath first screw and once again into the wall stud.

Congratulations on assembling your 7x9 Cozy Cabin Playhouse!

NOTE: Our Playhouses are shipped as an unfinished product. If exposed to the elements, the Western Red Cedar lumber will weather to a silvery-gray color. If you prefer to keep the cedar lumber looking closer to the original color, we suggest that you treat the wood with a good oil base wood stain. You may also wish to paint your new shed rather than stain it. In both cases, we recommend that you consult with a paint and stain dealer in your area for their recommendations.



We hope your experience assembling your playhouse has been both positive and rewarding.

We value your feedback and would like to hear back from you on how well we are doing in the following areas:

1. Customer Service
2. On Time Shipping
3. Motor Freight Delivery
4. Quality of Materials
5. Assembly Manual
6. Overall Satisfaction.

Please call, write or email us at:

Outdoor Living Today

Canadian Address
9393 287th Street
Maple Ridge, British Columbia
Canada V2W 1L1

United States Address
P.O. Box 96
Sumas, Washington
USA 98295



The materials contained in this Assembly Manual may be downloaded or copied provided that ALL copies retain the copyright and any other proprietary notices contained on the materials. No material may be modified, edited or taken out of context such that its use creates a false or misleading statement or impression as to the positions, statements or actions.