



9x9 Lauren's Cottage Playhouse Assembly Manual

Revision #11
June 27th, 2017

Thank you for purchasing a 9x9 Lauren's Cottage Playhouse. Please take the time to identify all the parts prior to assembly.



Safety Points and Other Considerations

Our products are built for use based on proper installation and normal residential use, on level ground. Please follow the instruction manual when building your Cabana and retain the manual for future maintenance purposes.

Some of the safety and usage measures you may wish to consider include:

- snow load ratings vary by geographical location. If heavy or wet snowfall occurs, it is advisable to sweep the snow off the roof(s).
- if the product is elevated, any structural and building code requirements are solely the customer's responsibility, and should be abided by.
- in high or gusty wind conditions it is advisable to keep the structure securely grounded.
- have a regular maintenance plan to ensure screws, doors, windows and parts are tight.

Customer agrees to hold Outdoor Living Today Partnership and any Authorized Dealers free of any liability for improper installation, maintenance and repair.

In the event of a missing or broken piece, simply call the Outdoor Living Today Customer Support Line @ 1-888-658-1658 within 30 days of the delivery of your purchase. It is our commitment to you to courier replacement parts, free of charge, within 10 business days of this notification. Replacement parts will not be provided free of charge after the 30 day grace period.

**Thank you for purchasing our 9x9 Lauren's Cottage Playhouse.
Please take the time to identify all the parts prior to assembly.**

A. Floor Section

- 2 - 45 1/2" x 88" - Floor Joist Frames (Interior Joist Unattached)
- 4 - 1 1/2" x 3 1/2" x 85" - Floor Joists
- 2 - 45 1/2" x 22" - Floor Joist Frames
- 1 - 14" x 88" - Floor Joist Frames
- 1 - 14" x 22" - Floor Joist Frames
- 2 - 5/8" x 45 1/2" x 88" - Plywood Floor Pieces
- 2 - 5/8" x 45 1/2" x 22" - Plywood Floor Pieces
- 1 - 5/8" x 14" x 88" - Plywood Floor Pieces
- 1 - 5/8" x 14" x 22" - Plywood Floor Pieces
- 5 - 1 1/2" x 3 1/2" x 59 1/2" - Floor Runners
- 5 - 1 1/2" x 3 1/2" x 45 1/2" - Floor Runners

B. Wall Section

- 7 - 35" x 60" - Solid Wall Panels (Bottom Wall Plates Unattached)
- 7 - 1 1/2" x 2 1/2" x 35" - Bottom Wall Plates
- 4 - 35" x 60" - Window Wall Panels
- 1 - 10" x 58 1/2" - Narrow Wall Panel
- 1 - 1 1/2" x 3" x 58 1/2" - Door Jamb
- 1 - 1 1/2" x 3" x 35" - Door Header
- 1 - 23" x 32 1/2" Bottom Door
- 1 - 23" x 25" Top Door

Gable Wall Panels

- 2 - Triangular End Gables (Left Side)
- 2 - Triangular End Gables (Right Side)
- 1 - Dormer Gable with Window (2 Triangular Corner Gable Trim attached)

Top Wall Plates

- 2 - 1 1/2" x 2 1/2" x 55" - Rear Top Plate (Angle cut edge 45 deg.)
- 2 - 1 1/2" x 2 1/2" x 45" - Front Top Plates
- 2 - 1 1/2" x 2 1/2" x 10" -Front Corner Top Plates (Angle cut edge 45 deg)
- 4 - 1 1/2" x 2 1/2" x 50" - Side Top Plates

C. Rafter and Roof Section

- 9 - 1 1/2" x 2 1/2" x 79" - Rafters (angle cut & drilled)
- 1 - Left Front Rafter Section
- 1 - Right Front Rafter Section
- 1 - Center Front Rafter Section
- 1 - Left Front Dormer Rafter Section
- 1 - Right Front Dormer Rafter Section
- 1 - 3/4" x 4 1/2" x 63 1/2" - Rear Ridge Boards
- 1 - 3/4" x 4 1/2" x 48" - Rear Ridge Boards
- 2 - 1/2" x 4 1/2" x 55 3/4" - Rear Soffits
- 2 - 1/2" x 4 1/2" x 8 3/8" - Front Corner Soffits

Roof Panels

- 1 - Rear Left Side Roof Panel (Shingles overhanging Plywood on 1 side)
- 1 - Rear Center Roof Panel (Shingles Flush with Plywood both sides)
- 1 - Rear Right Side Roof Panel (Shingles overhanging Plywood on 1 side)
- 1 - Front Left Side Roof Panel (Shingles overhanging Plywood on 1 side)
- 1 - Front Center Roof Panel
- 1 - Front Right Side Roof Panel (Shingles overhanging Plywood on 1 side)
- 2 - Triangular Dormer Roof Panels (1 left / 1 right)
- 2 - 6" x 8' - Flex Flashing Pieces
- 2 - 1/2" x 2 1/2" x 80" - Valley Trim Boards
- 25 - Cedar Ridge Cap Shingles
- 22 - 16" Long Cedar Roof Filler Shingles
- 2 - 3/4" x 3 1/2" x 24" - Roof Gussets - Angle Cut on both ends

D. Miscellaneous Section

Bottom Skirting

- 12 - 1/2" x 4 1/2" x 35" - Bottom Skirting

Corner & Sidewall Trim

- 13 - 1/2" x 2 1/2" x 64" - Wall Seam and Door Trim
- 4 - 1/2" x 2 1/2" x 60" - Filler Trims
- 4 - 1/2" x 4 1/2" x 64" - Corner Trims
- 1 - 1/2" x 2 1/2" x 23 1/2" - Above Door Trim
- 1 - 1/2" x 2 1/2" x 5 3/4" - Narrow Wall Trim

Facia Trim

- 4 - 3/4" x 5 1/2" x 80" - Side Facia (Angle cut on ends)
- 2 - 3/4" x 5 1/2" x 68" - Dormer Facia (Angle cut on ends)
- 2 - 3/4" x 5 1/2" x 21 3/4" - Front Corner Facia
- 2 - 3/4" x 5 1/2" x 60 1/2" - Rear Facia

****Miscellaneous Pieces**

- 4 - Flower Boxes Kits
- 4 - Aluminum Window Inserts
- 4 - Window Trim Pkgs - (1-24 1/16" angle cut / 3 -23" square cut)
- 3 - Pentagon Facia Peak
- 1 - Facia Detail Plate
- 2 - Dormer Window Shutters
- 1 pc Spare Wall Siding
- 2 pcs Spare Shingles (Use to shim door, etc)

E. Loft Section

- 3 - 34 7/8" x 69" - Loft Floors (Left, Center, Right)
Left and Right have Chain Holes
- 2 - 1 1/2" x 3 1/2" x 58 1/2" - Floor Support Posts
- 2 - 1 1/2" x 3 1/2" x 52 1/2" - Front Floor Support Joists -Notched
- 2 - 1 1/2" x 5 1/2" x 52 1/2" - Rear Floor Support Joists - Drilled
- 1 - 32 1/4"H x 88 1/2" - Safety Railing
- 1 - 20" x 64" - Ladder

Note: All Trim, Facia and Bottom Skirting pieces will be positioned rough face out when installed.

LAUREN'S COTTAGE HARDWARE PACKAGE

Hardware Kit (Provided)

Note: screws and nails shown actual size.

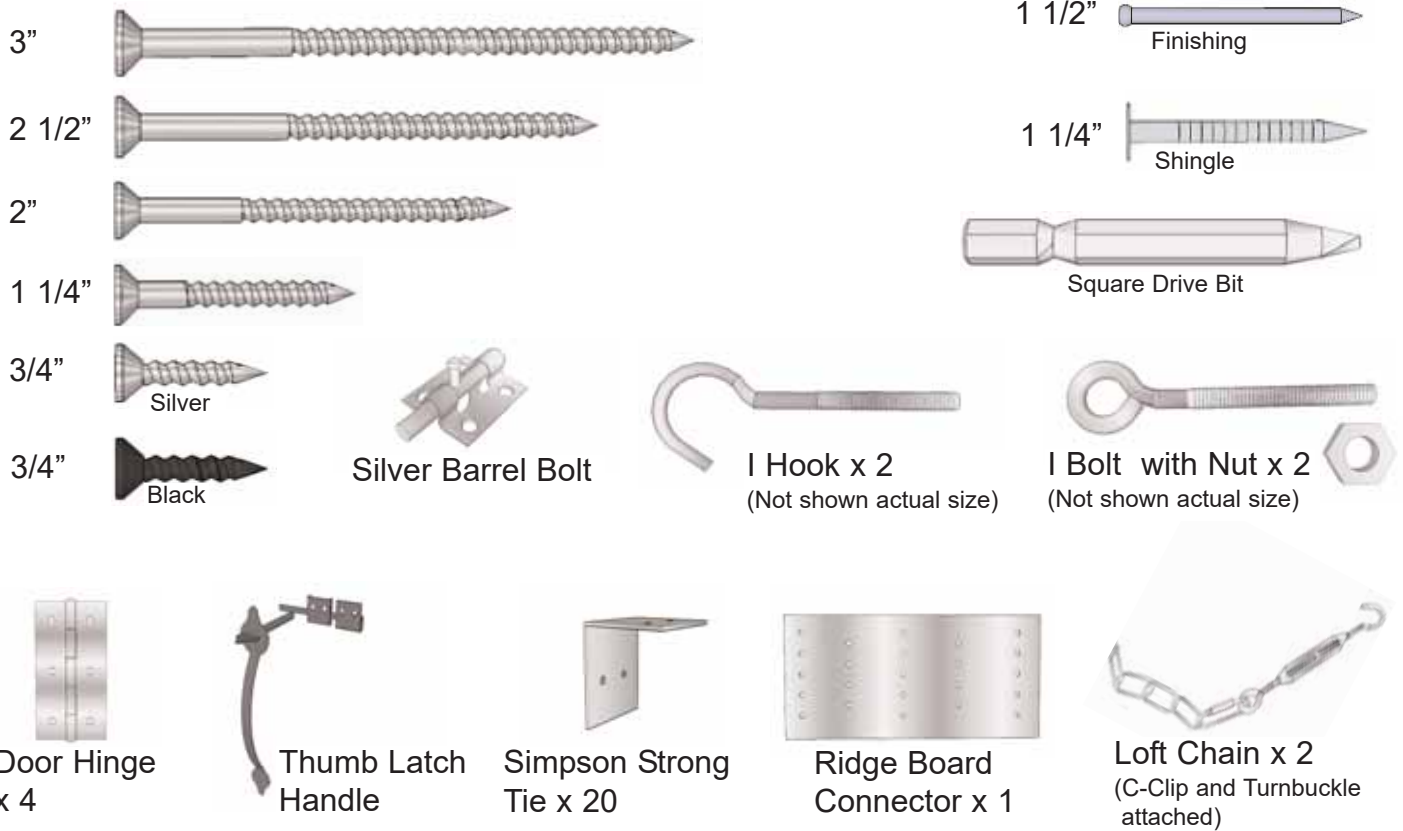

Tools Required (Not Provided)

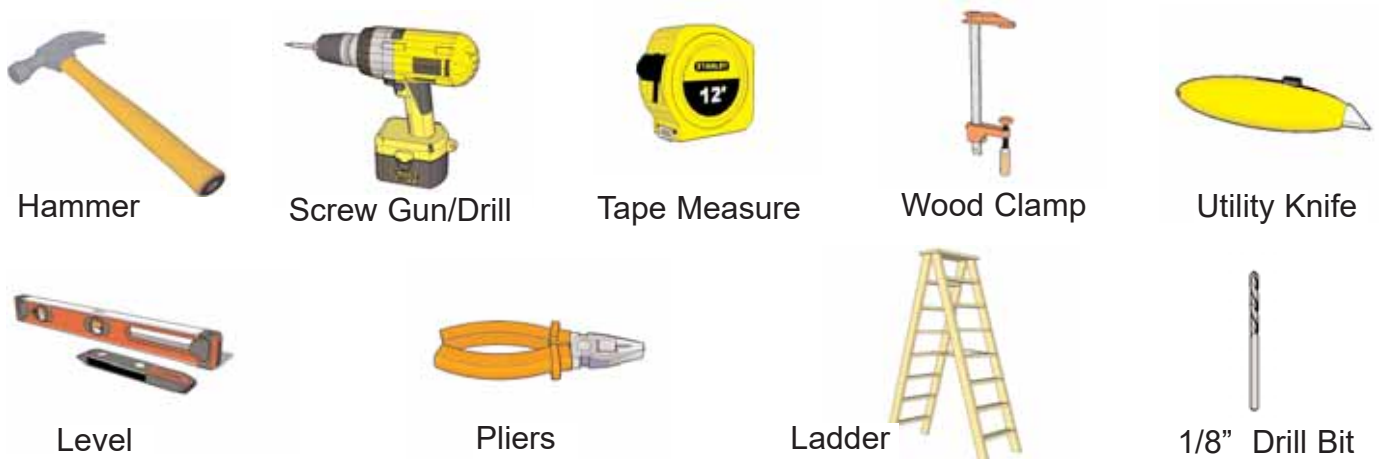

Safety Equipment Required (Not Provided)



A. Floor Section

Exploded view of all parts necessary to complete Floor Section. Identify all parts prior to starting.

Note, Floor Footprint is 110" wide x 105" deep.

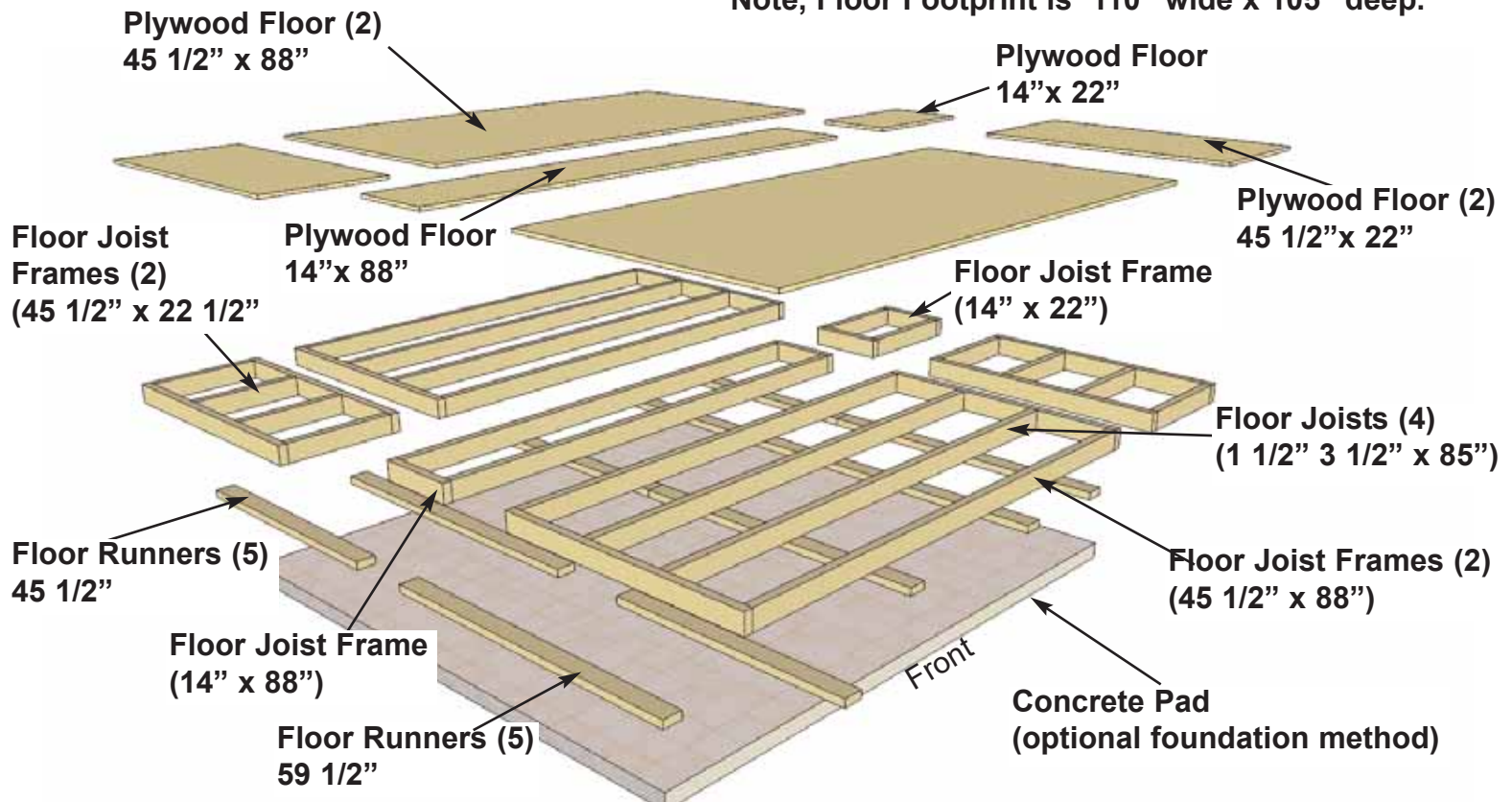

Flush with framing



1. Lay out **Larger Floor Joist Frame** and **2 Floor Joists** as illustrated above. Position Joists equally in Floor Joist Frame. Use **Small Floor Joist Frame** as a template to determine joist position. Position Joist so flush with framing.

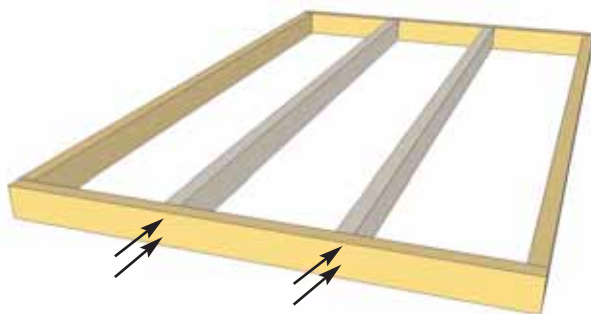

2. When correctly positioned, attach each Joist with 4 - 2 1/2" screws (2 per end).

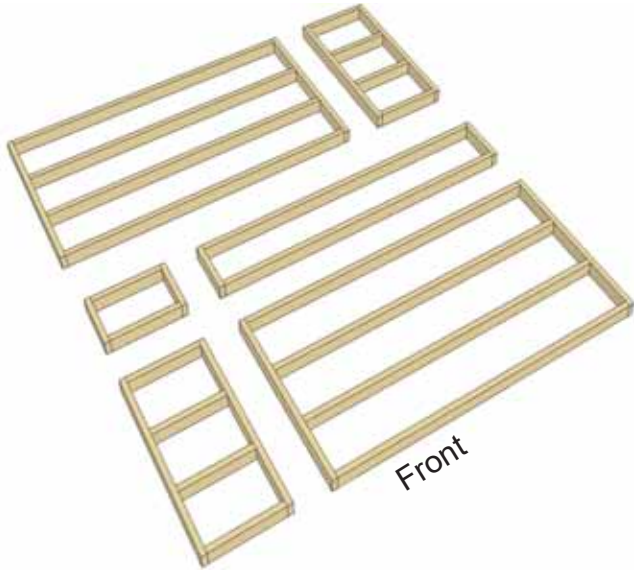

3. Lay out **Floor Joist Frames** as illustrated at left. The Footprint for the floor when attached together will be 110" wide x 105" deep.

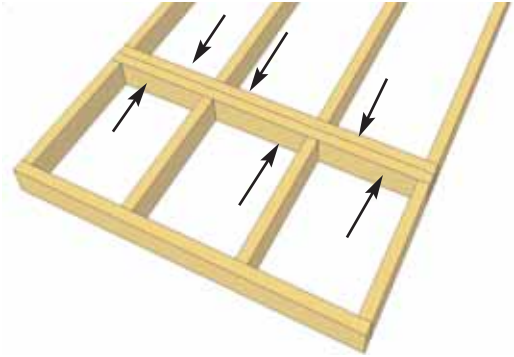

4. Attach each large and small floor joist frames together with 6 - 2.5" screws per section.

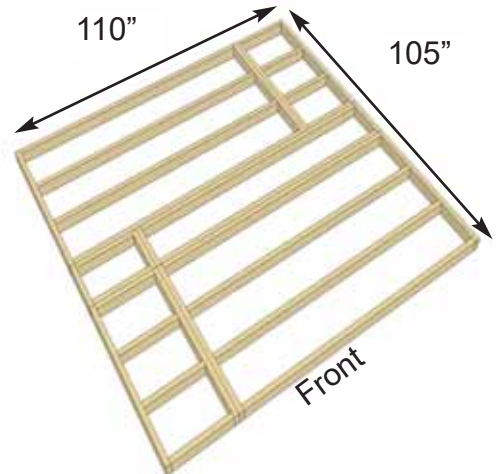
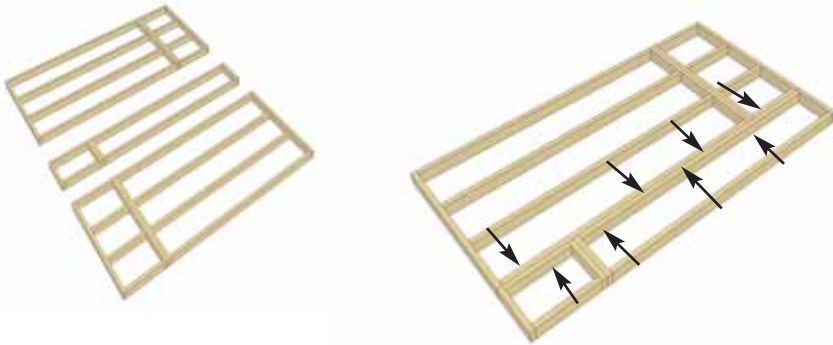

5. Complete all large and small frame attachments. Screw each completed section together with 8 - 2.5" screws.

6. When completed, your floor footprint should be 110" wide x 105" deep.

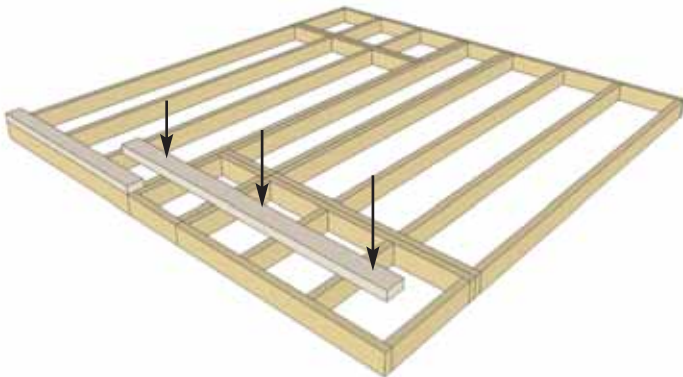

7. Attach **Floor Runners** to completed floor frame. There are 2 floor runners per 105" side and 5 completed runners in total. Use 6 - 2.5" screws per Runner.

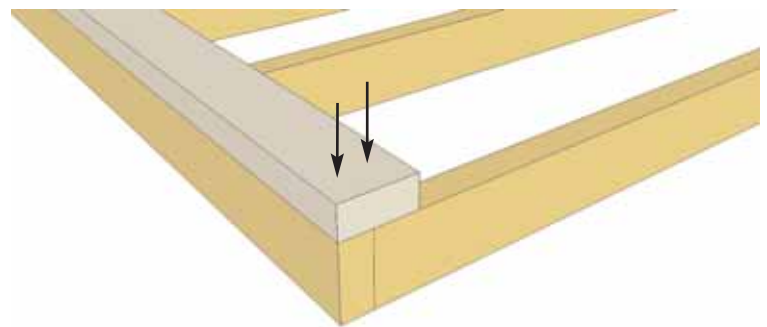

8. Make sure Runners are flush with outside and front and rear floor framing but not overhanging.



9. Complete all Floor Runners.

Foundations

Note: The floor will be flipped over and floor runners will sit on your foundation. It is important to note that having a level foundation is critical. Choosing a foundation will vary between regions. Typical foundations can be concrete pads or patio stones positioned underneath the floor runners.

11. Position **Plywood Floor** pieces (6) on top of completed floor joists. Plywood will sit flush with outside of floor joist frame. Plywood is cut slightly smaller than floor framing. Keep plywood seams tight.

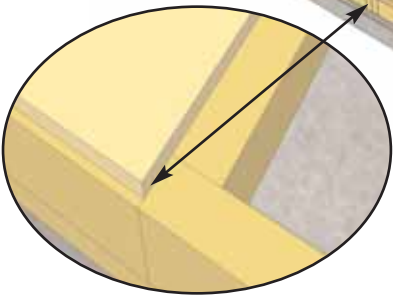
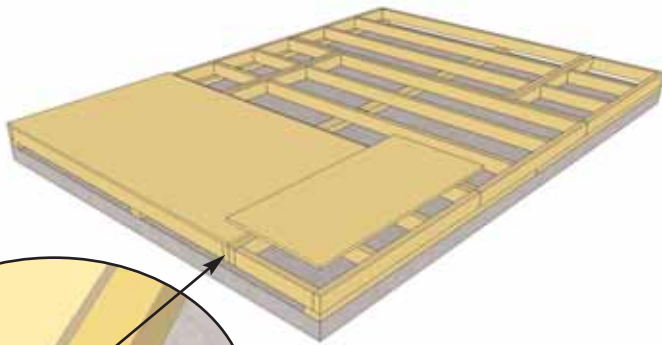

Hint: Use a chalk line to mark location of floor joists to determine screw placement.

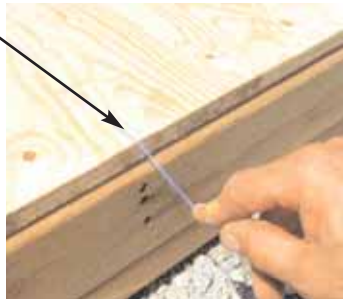

Concrete Slab Foundation

10. With Floor Runners attached, carefully flip the floor over and place on your foundation. **Caution-** you will need 2 people to assist you. Be careful when laying floor down not to bend or twist floor. When in place, level floor completely.

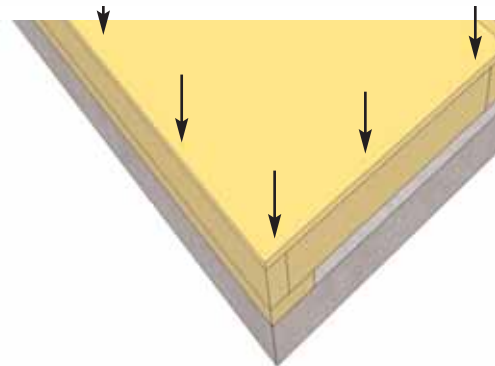
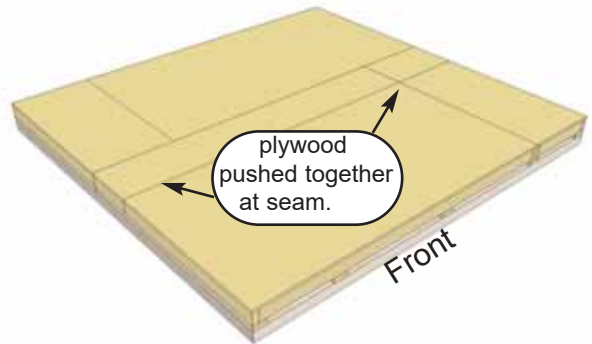

12. With Plywood positioned correctly on floor framing, attach with 1 1/4" screws. Use screws every 16".

B. Wall Section

Exploded view of all parts necessary to complete the Wall Section. Identify all parts prior to starting.

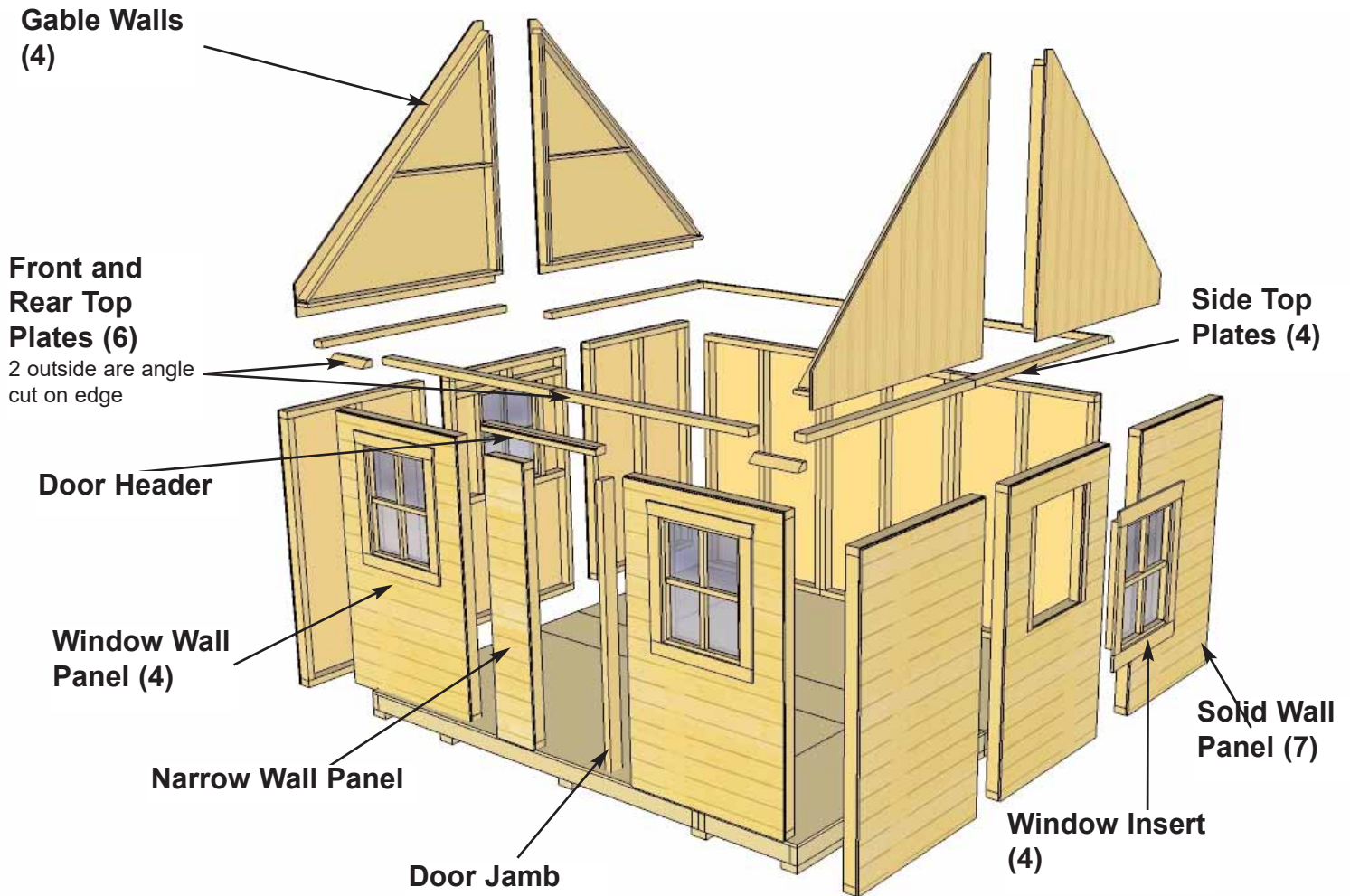

13. Lay out all the wall panels and become familiar with their location.

On Standard Kits, there is **4 Window Wall Panels, 7 Solid Wall Panels and 1 Narrow Wall Panels.**

Make sure to position panels right side up so water is directed away from and not into shed. Look at window wall panels to determine proper wall position to confirm.

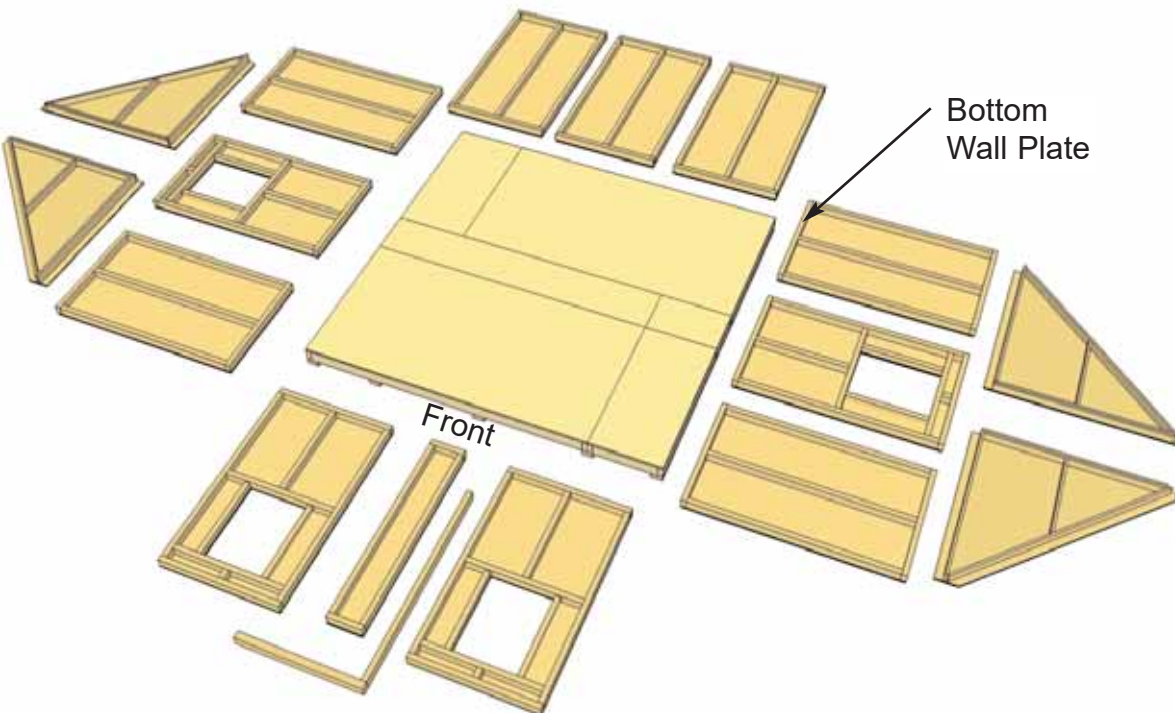

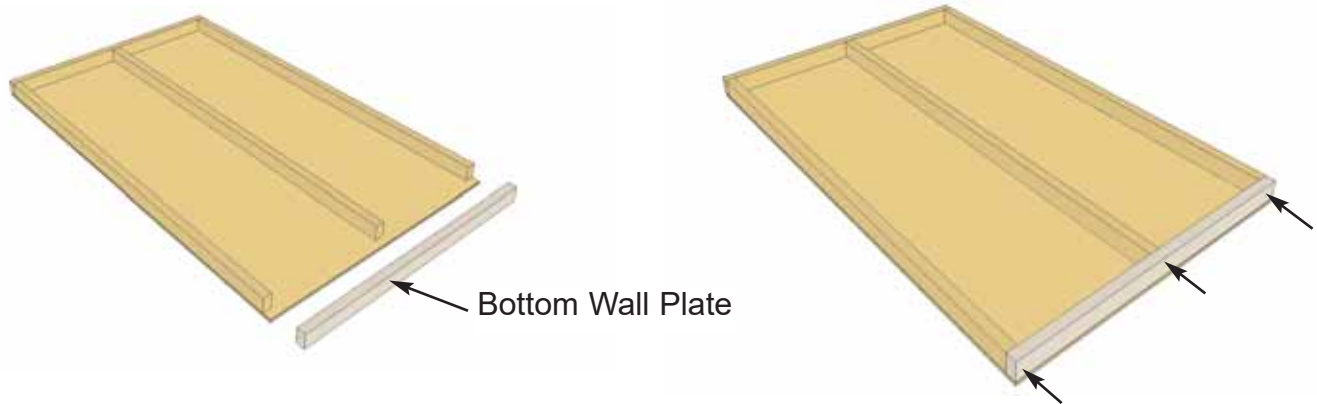

14. If Bottom Plate on some **Solid Walls** is not attached, start by carefully laying panel face down. Position and attach **Wall Plate** to bottom of wall studs of each wall panel with 3 - 2 1/2" screws. Position so plates are flush with framing. Note, some Bottom Wall Plates may already be attached to some Solid Walls.

15. Starting at Rear Corner, position a Solid Wall Panel on top of plywood floor. The Wall Panel bottom framing will sit flush with plywood. Wall siding will overhang the floor.

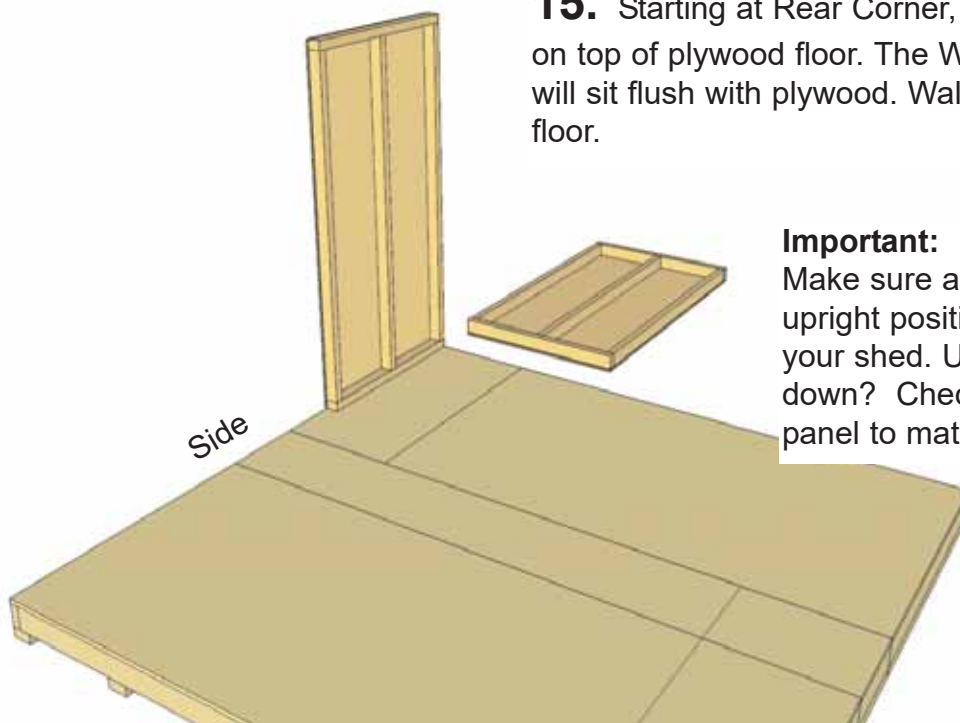

Important:

Make sure all walls are aligned in their upright position. If not, water may leak into your shed. Unsure if panel is facing up or down? Check siding on window wall panel to match alignment.

16. The side wall panels will sit flush at the end of the plywood floor with the rear wall panels sandwiched between them.

Note: Siding will overhang the floor by approx. 1/2"

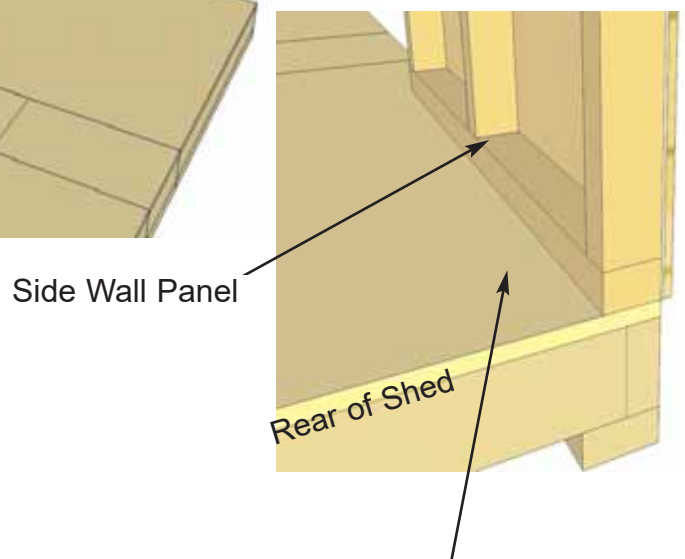

Outside 2x3 framing of wall panel is flush with outside of plywood when properly aligned.

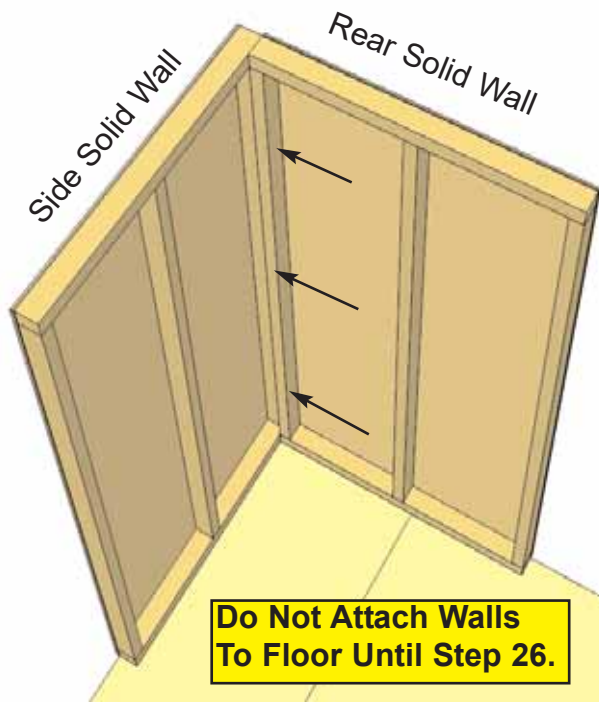

17. Position rear solid wall into place on plywood floor. Butt both vertical wall studs of side and rear walls together and attach with 3 - 2.5" screws. Screw at the bottom, middle and top of stud to secure properly.

Do Not Attach Walls To Floor Until Step 26.

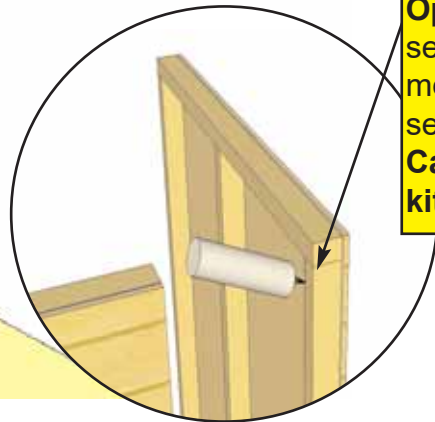

Optional - Caulking seams will help prevent moisture from entering at seam. Caulking not included in kit.

18. With the corner wall attachment complete, position remaining rear wall panel in place so bottom 2x3 wall framing is sitting flush with outside floor joists and plywood floor. Wall siding should overhang floor by approximately 1/2" When positioned correctly, attach both wall panel studs together as per **Step 17**.

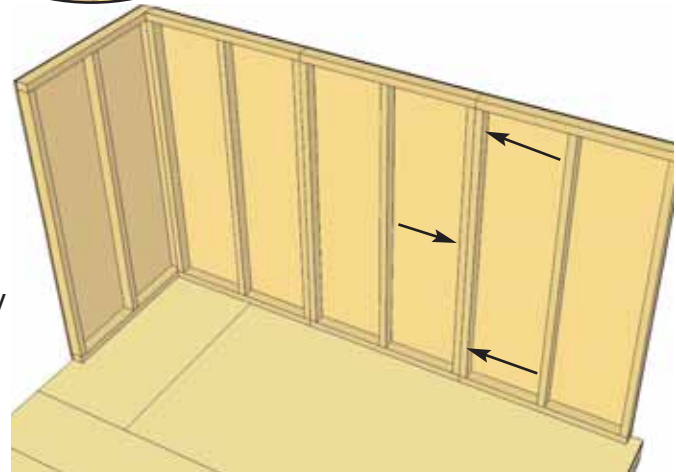
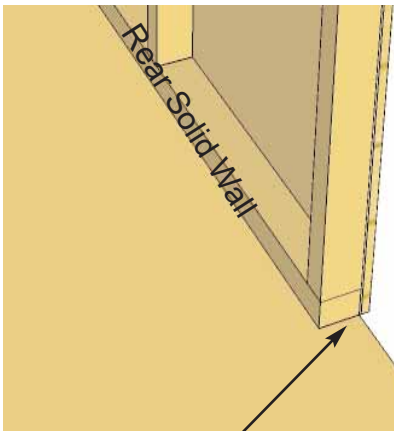

2x3 wall framing flush with outside of plywood.

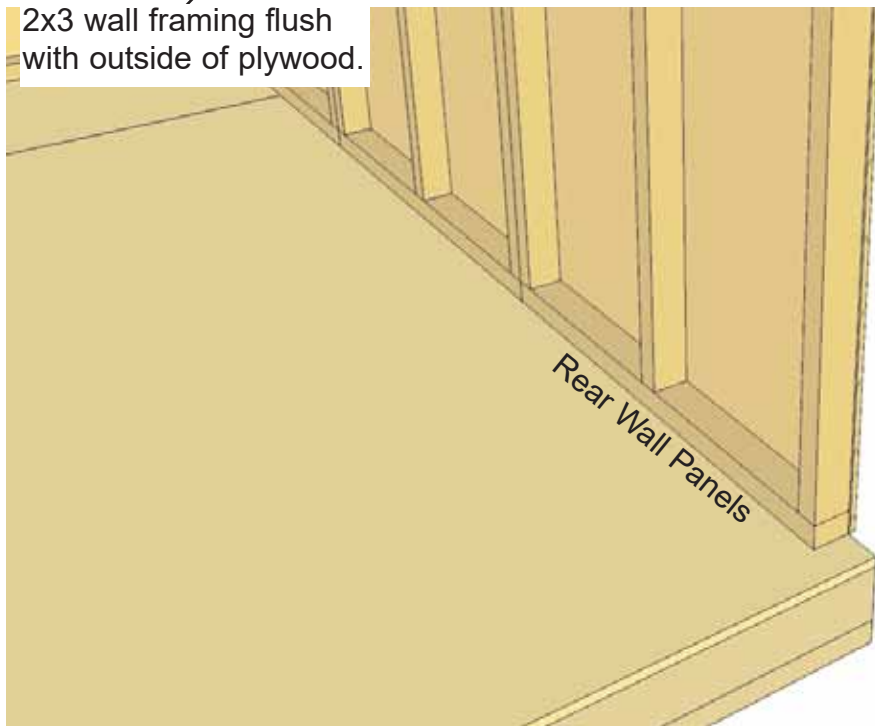

Be sure that rear wall panels fit between the side wall panels. (sandwiched)

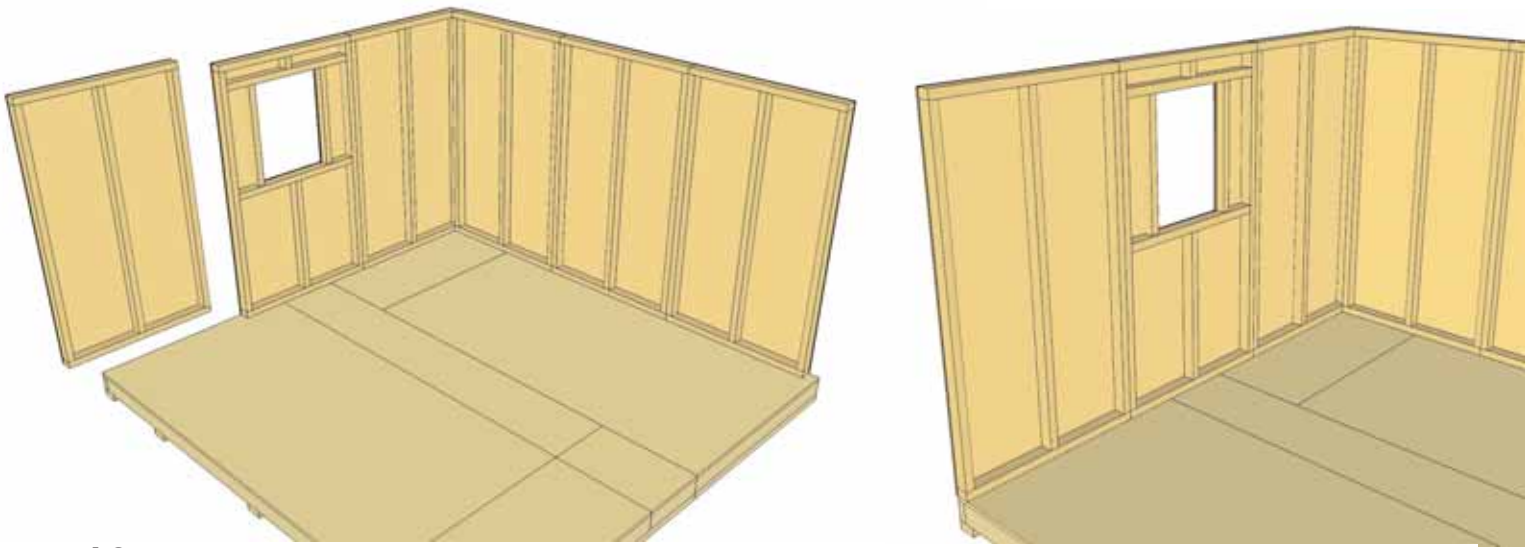

19. Start positioning and securing wall panels around your floor. Attach wall studs together as per **Step 17**.

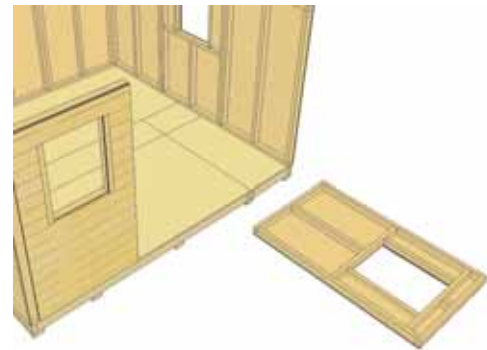
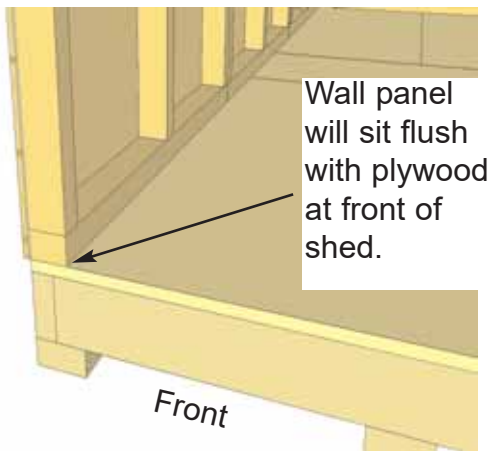

20. Complete all side and rear wall attachments. Attach as per **Step 17**.

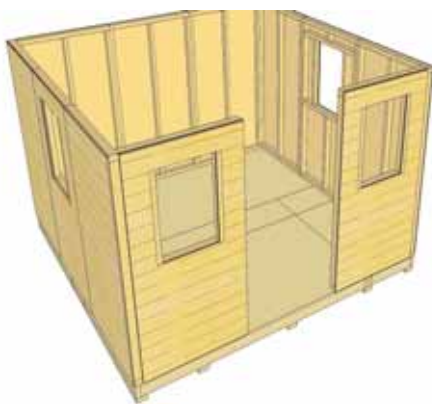

21. Place both Window Wall Panels in front and attach.

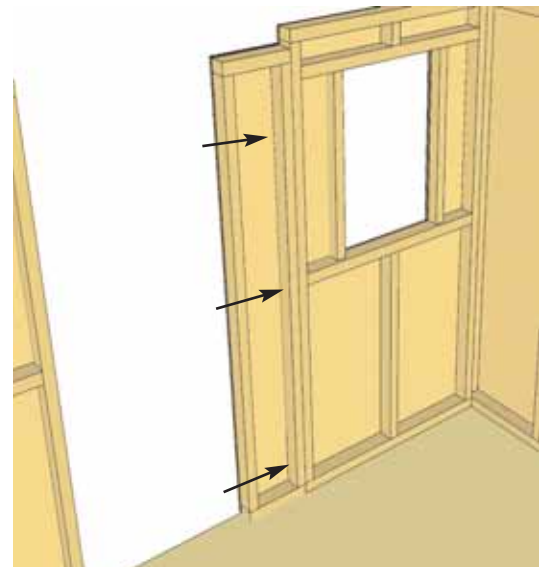
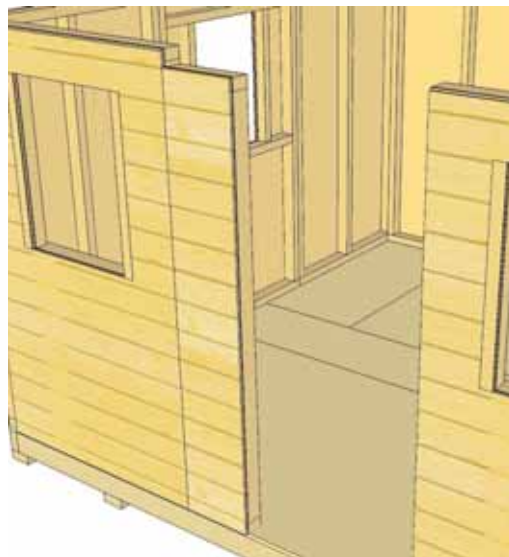

22. Position and attach Narrow Wall Panel to left side wall stud with 3 - 2.5" screws as per **Step 17**. **Note**, Narrow Wall is 58 1/2" high (1.5" shorter than wide walls).



23. Locate **Window Inserts** and **Window Trim Packages**. Before installing, run a bead of caulking around window opening perimeter. Position window in cavity and secure with 8 - 1 1/4" screws. Position Window Trim around window doing a dry run first and attach with 4 - 1 1/2" finishing nails per piece. **Trim Sizes = 1x 24 1/16" = top / 3 x 23" = Sides & Bottom.**

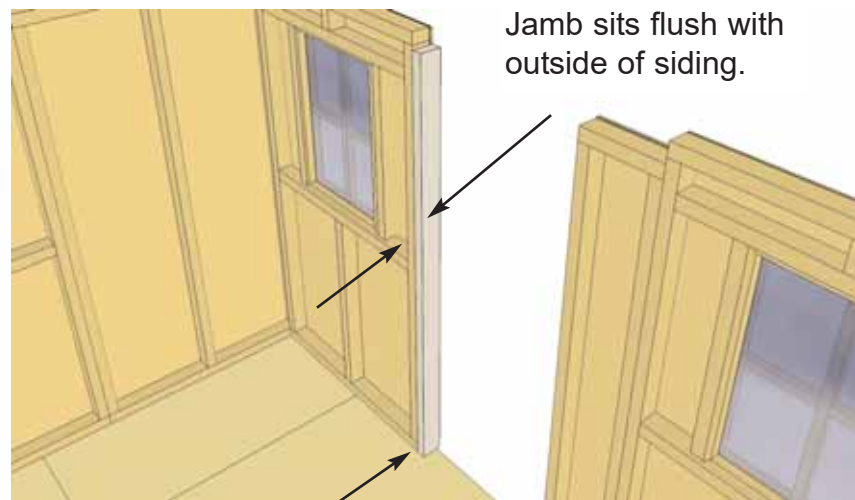

Jamb sits flush with outside of siding.

24. Locate Vertical Door Jamb and position flush against right wall panel stud. The Jamb is 3" wide and will sit flush to outside of wall siding. When positioned correctly, secure Jamb using 4 - 2.5" screws.

Header is 1 1/2' thick x 3" wide.

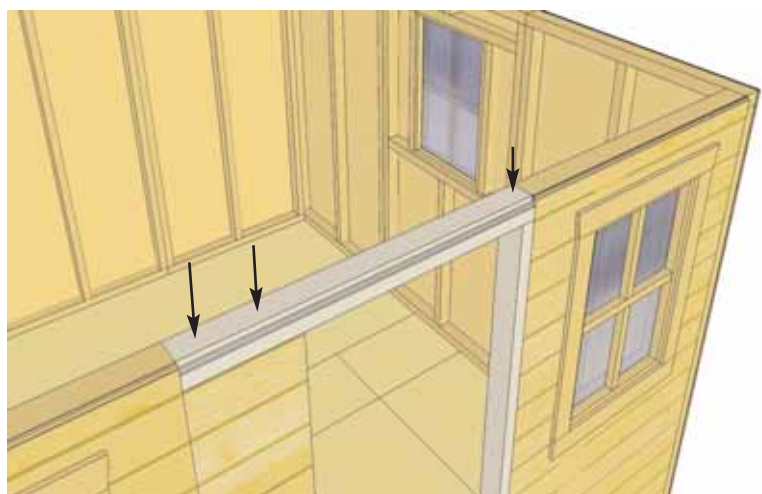
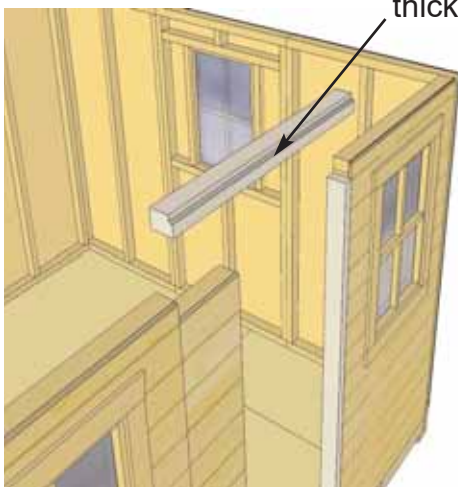

25. Position and attach the Door Header to Door Jamb and Narrow Wall Panel top framing. Header should sit flush with Door Jamb and Outside of Narrow Wall Panel Siding. Attach with 3 - 2.5" screws.

Optional - Caulking seams will help prevent moisture from entering at seam.
Caulking not included in kit.

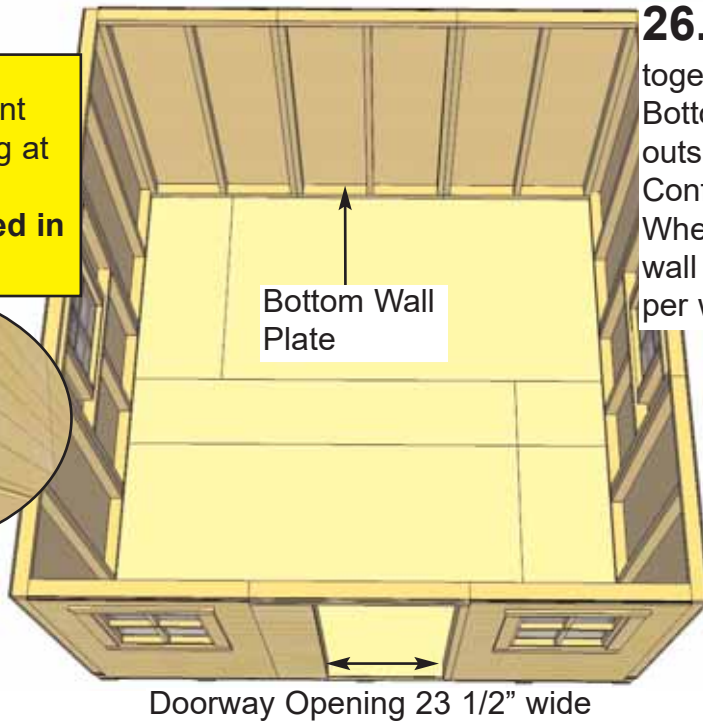
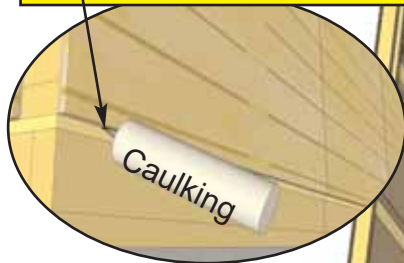

26. When all walls are attached together, check alignment with the floor. Bottom wall framing should sit flush with outside of floor joists and plywood floor. Confirm doorway opening is 23 1/2" wide. When positioned correctly, fasten bottom wall plates to floor using 4 - 2.5" screws per wall panel.



Angle screws into perimeter Floor Joists.

27. Position **Rear Top Plates** on top of wall studs so it is flush on the inside with 2x3 wall framing. There are 2 pieces of Rear Top Plates angle cut down the edge. Attach by screwing down into top wall framing with 4 - 2 1/2" screws per piece.

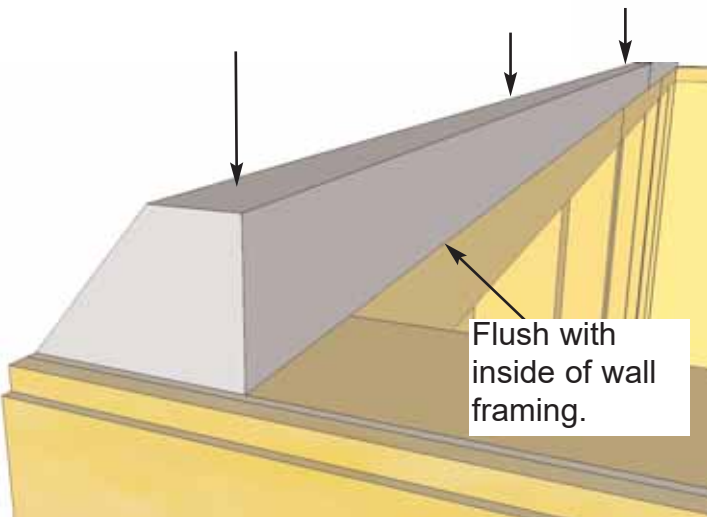
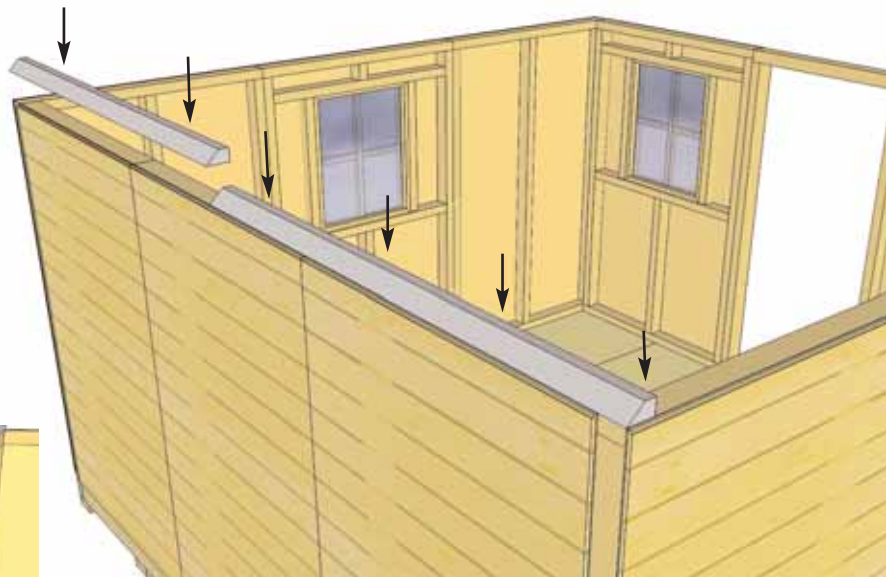

Flush with inside of wall framing.

28. Next, attach the **Side Top Plates** (2 per side). The side top plates are square cut. Once again, position top plate on wall plate so it is flush with inside of wall plate. Side plate should be tight with end of Rear Top Plate.

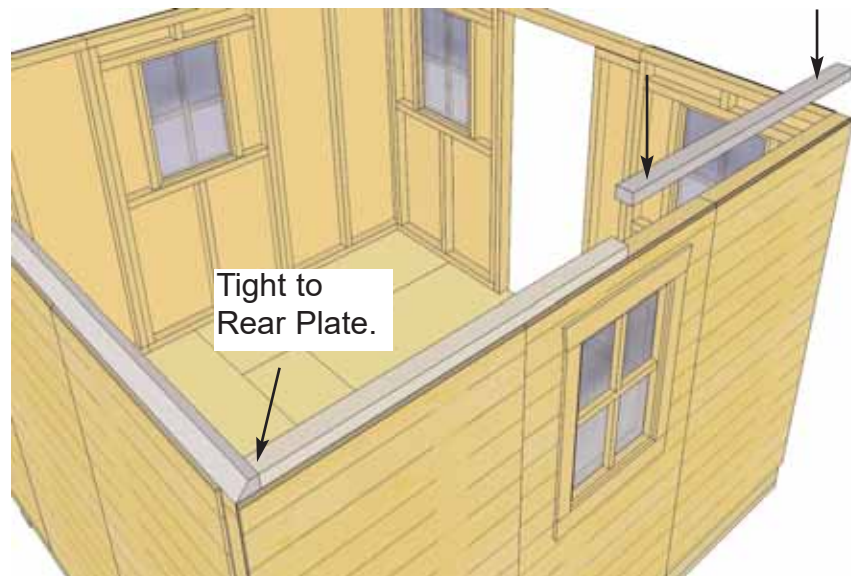

Tight to Rear Plate.

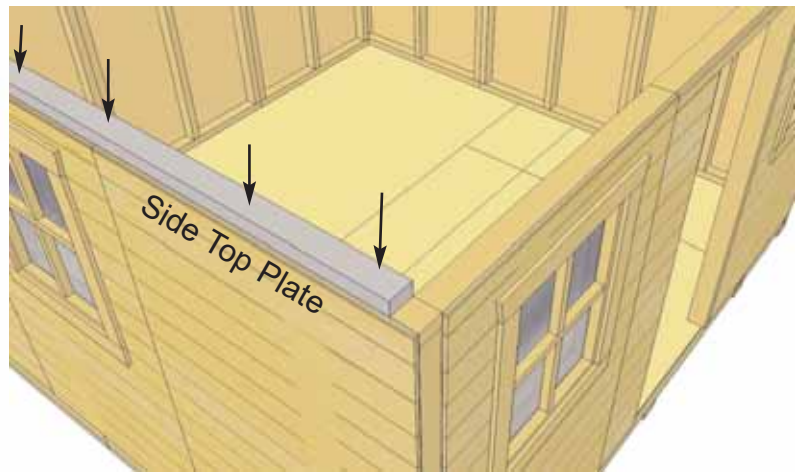
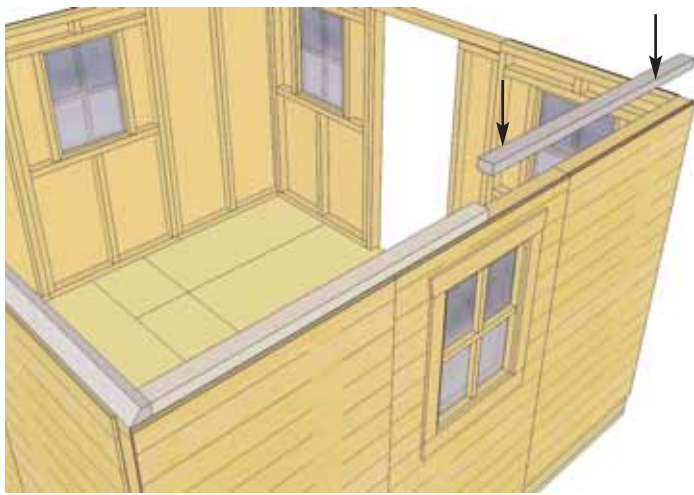

28a. When Side Top Plates are correctly positioned, secure with 4 - 2 1/2" screws per piece.

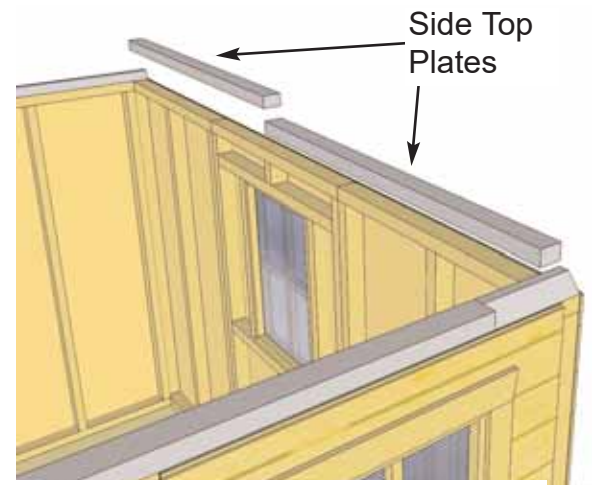
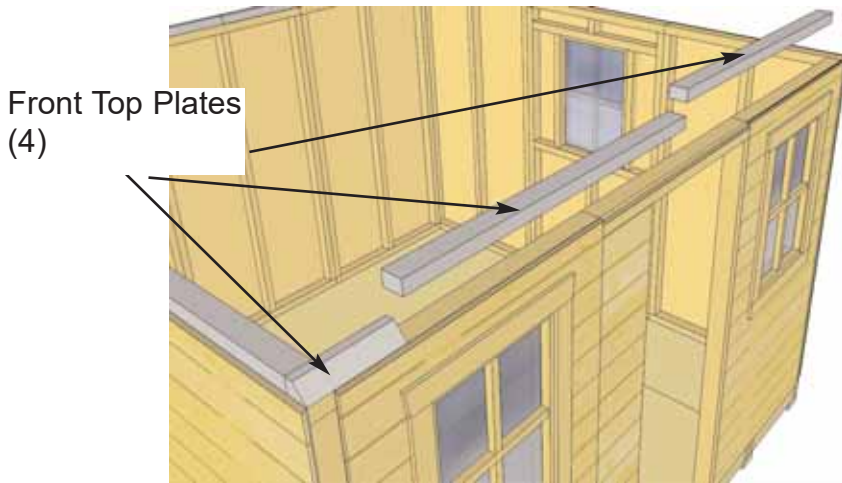

29. There are 4 Front Top Plates. Two Front Corner 10" long (45 degree angle cut on edge) and 2 Front 45" square cut pieces. Position as per **Step 28**. Use 2 - 2 1/2" screws for Corner Pieces and 4 screws per middle piece. Complete remaining Side Top Plates.

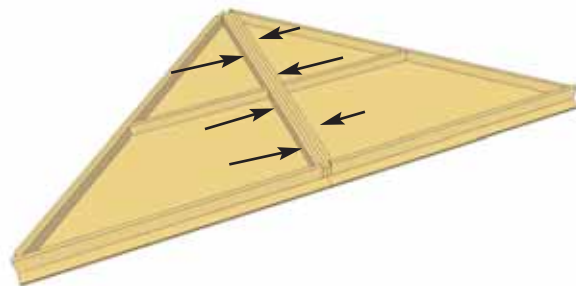
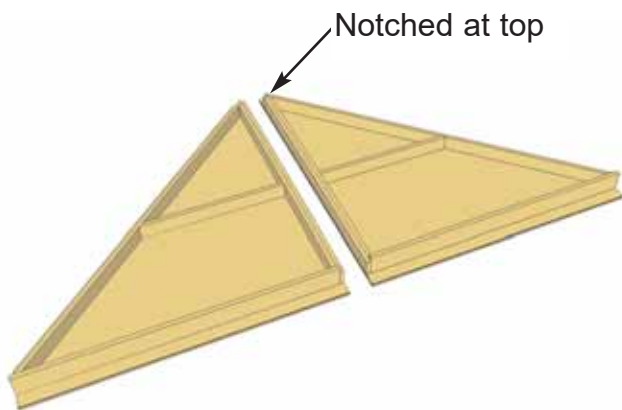

30. . Locate Gable 1/2 Walls for both sides of the shed. Screw center wall framing of each piece together with 6 - 2 1/2" screws.

Note, prior to attaching, check from front (siding side) to confirm siding lines up reasonably well. Try each combination prior to attaching together to get the best fit.

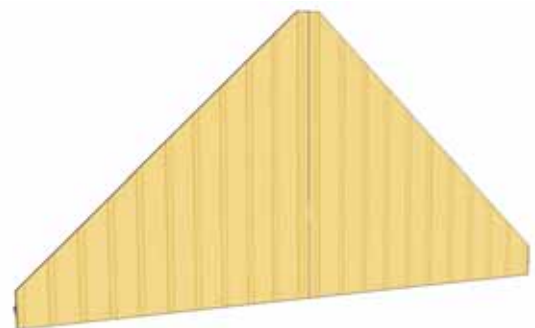

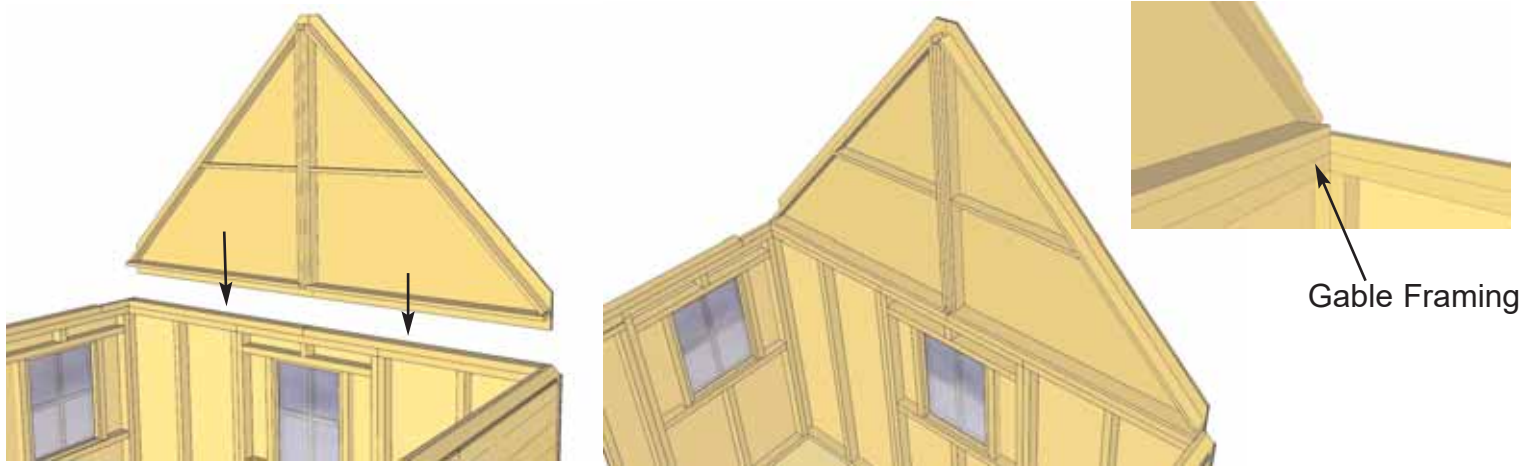

31. Lift up a completed gable section and place on top of Side Wall Top Plate. The gable framing should sit flush with the inside of the top plate.

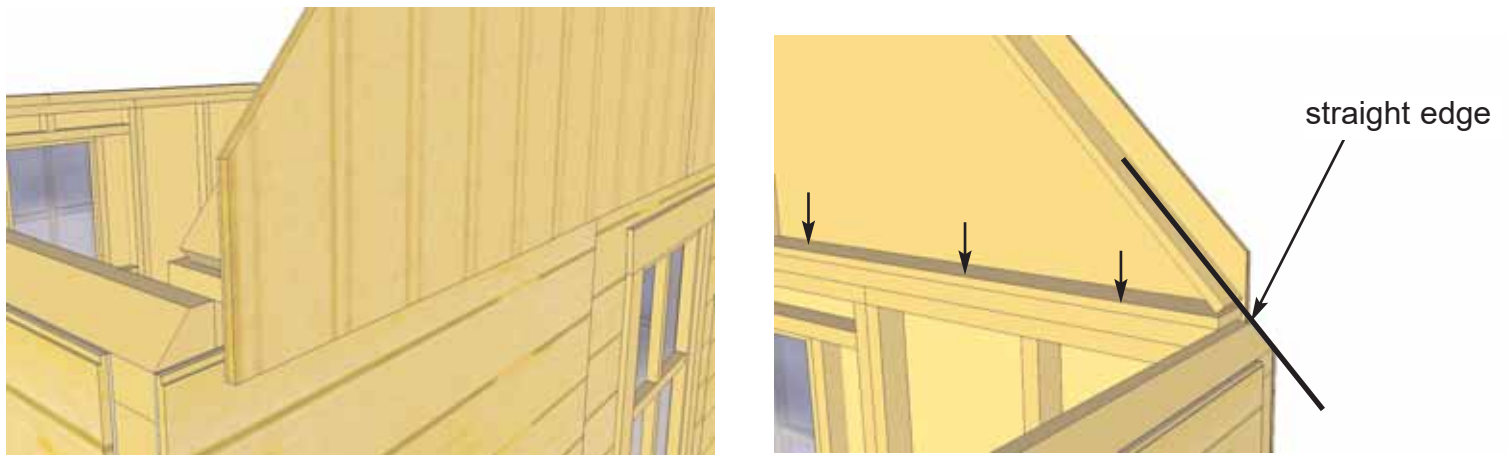

32. The gable should be centered sideways (left to right) on the top plate. **Hint:** use a straight edge to check the angle of the gable framing and top plate. Both angles should line up. Adjust gable accordingly. When positioned correctly, attach to walls and top plate with 8 - 2" screws. Screw from gable framing down into Top Plate and Wall. (See illustration above).

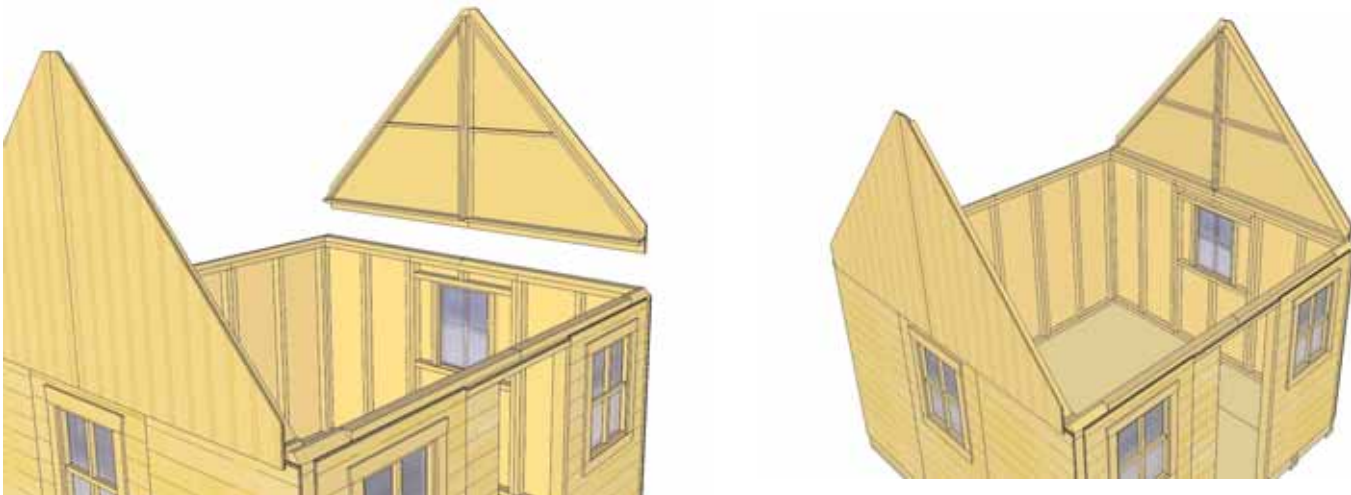

33. Complete positioning and attachment of other front gable as per **Step 32.**

C. Rafter and Roof Section

Exploded view of all parts necessary to complete the Roof Section. Identify all parts prior to starting. (Roof Filler Shingles and Roof Flashing Missing)

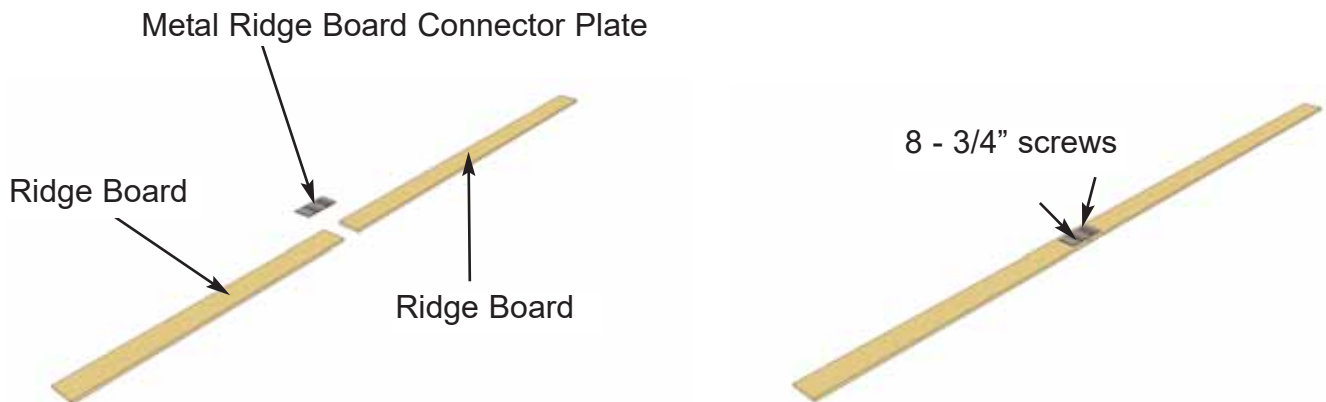
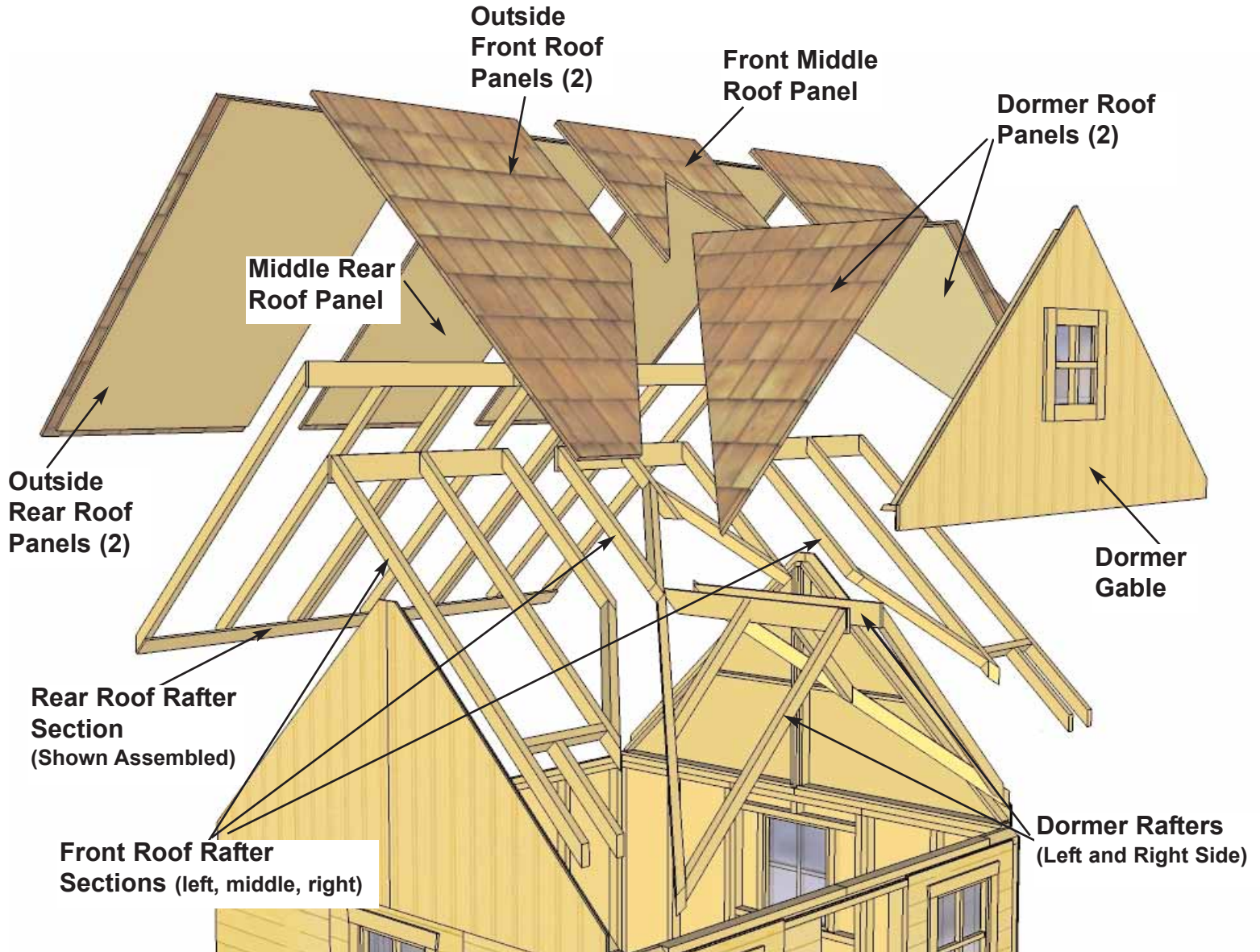

34. Begin Rafter Assembly with Rear Rafter Section. Locate 3/4" x 4 1/2" x 63 1/2" & 48" **Ridge Boards** and attach together with **Metal Ridge Board Connector Plate** using 8 - 3/4" screws.

35. Locate 9 Rafters, 2 Soffits and completed Ridge Board. Lay out on level ground as shown to right. Note, completed rafter section will be flipped over in **Step 38**.

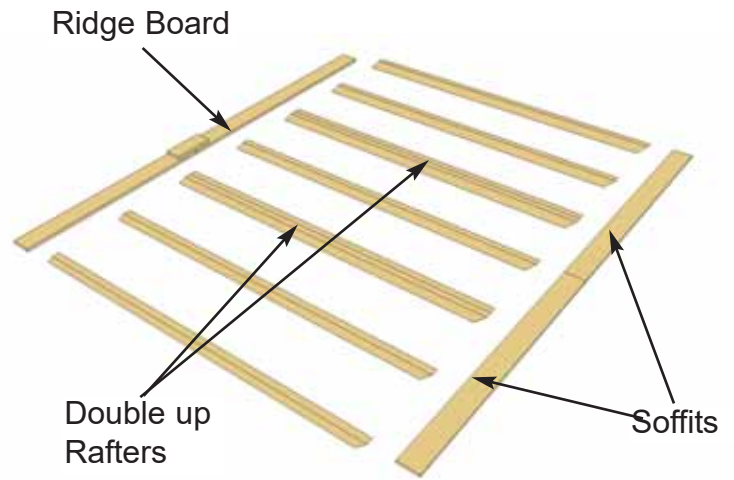

36. Attach completed Ridge Board to ends of both outside rafters with 2 - 2" screws per end. Measure and position interior Rafters as illustrated below. When positioned correctly, attach Ridge Board to remaining rafters with 2 - 2" screws /rafter end.

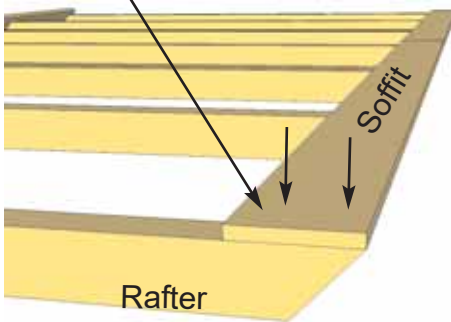
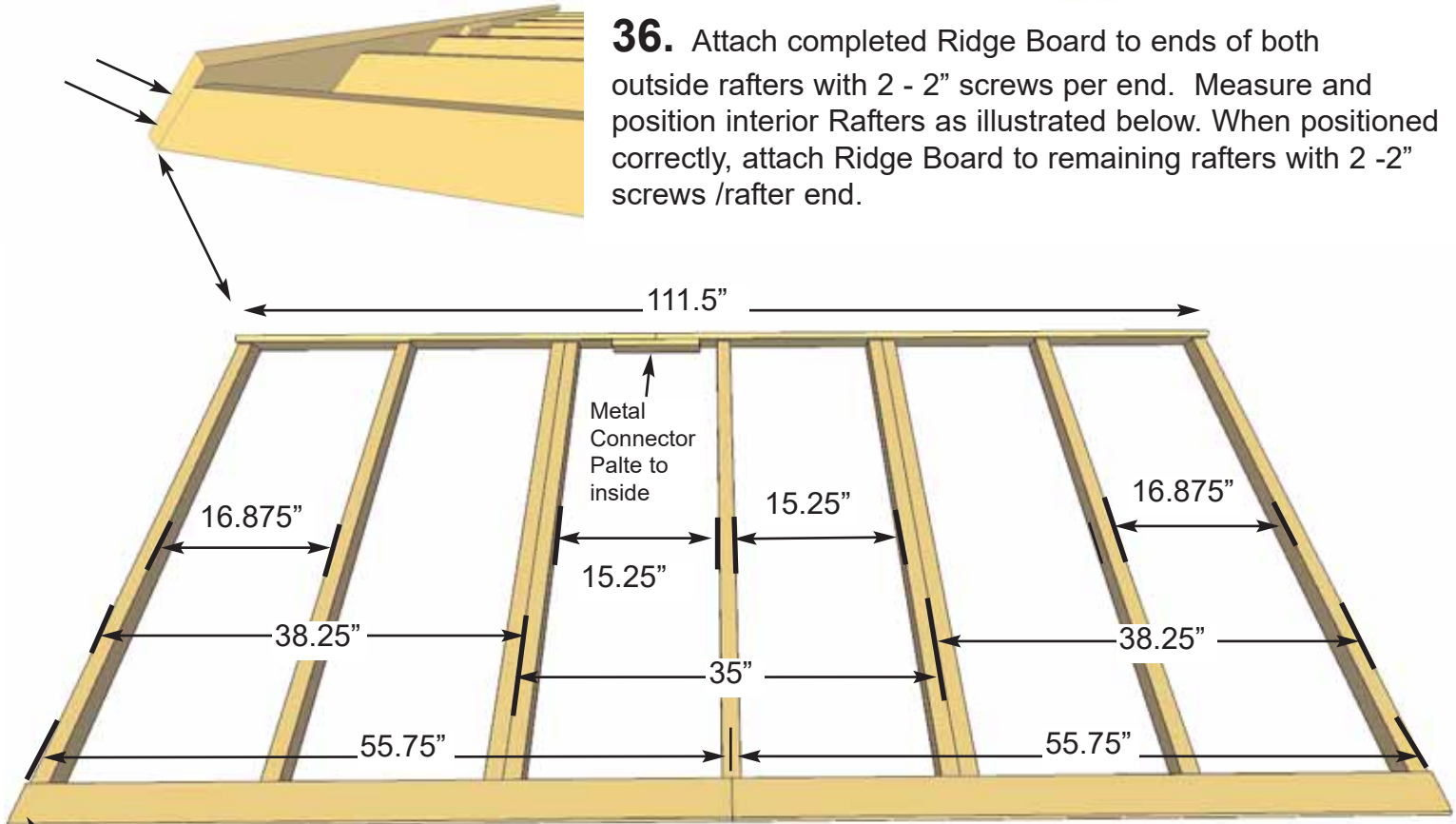

37. Attach end of a 55 3/4" long Soffit Board flush to ends of outside rafters with 2 - 1 1/4" screws per rafter end. Drill pilot hole in Soffit ends to prevent splitting. Complete both outside rafter / Soffit connections first. Measure and position interior Rafters as illustrated above. When positioned correctly, attach Soffits to remaining rafters with 2 - 1 1/4" screws /rafter. Flip completed rafter section over.

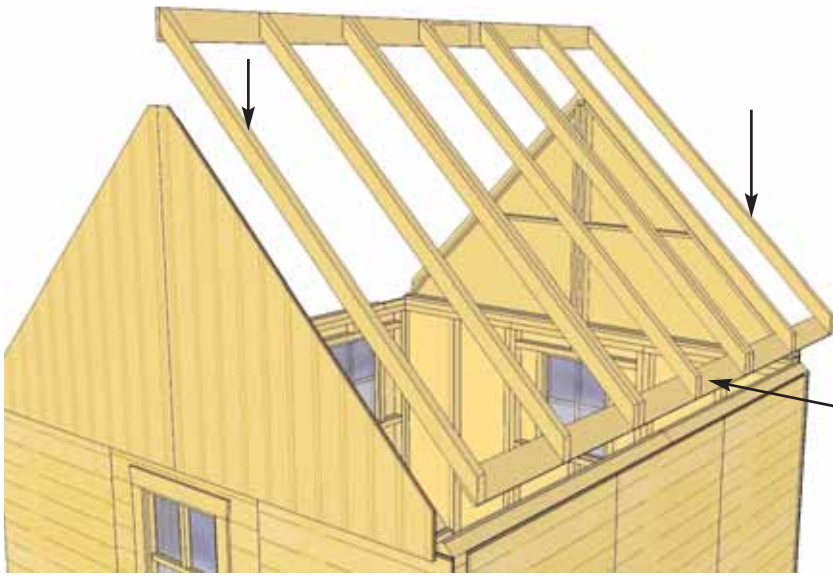

38. Position Rear Rafter Section on end gable. (Make sure Soffit is facing down).

Soffit



Soffit should sit flush against wall panel.

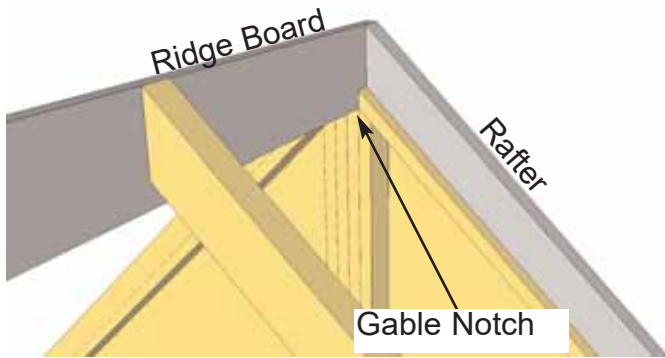

39. Slide Rafter Section up on gable framing until bottom of Ridge Board slips into gable notch.

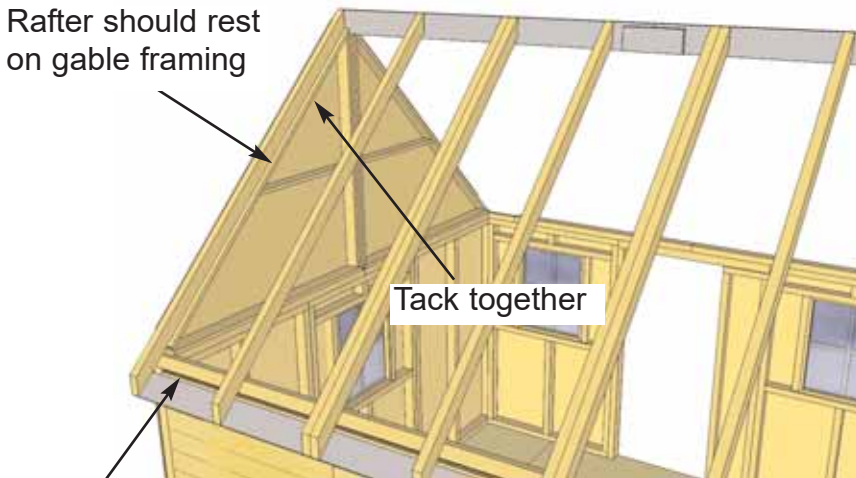

Soffit should sit flush against wall panel.

40. When Rafter Section is positioned correctly on gable framing on both sides, tack in place to hold position with 2" screws..



Ridge Board
Overhand facing up.

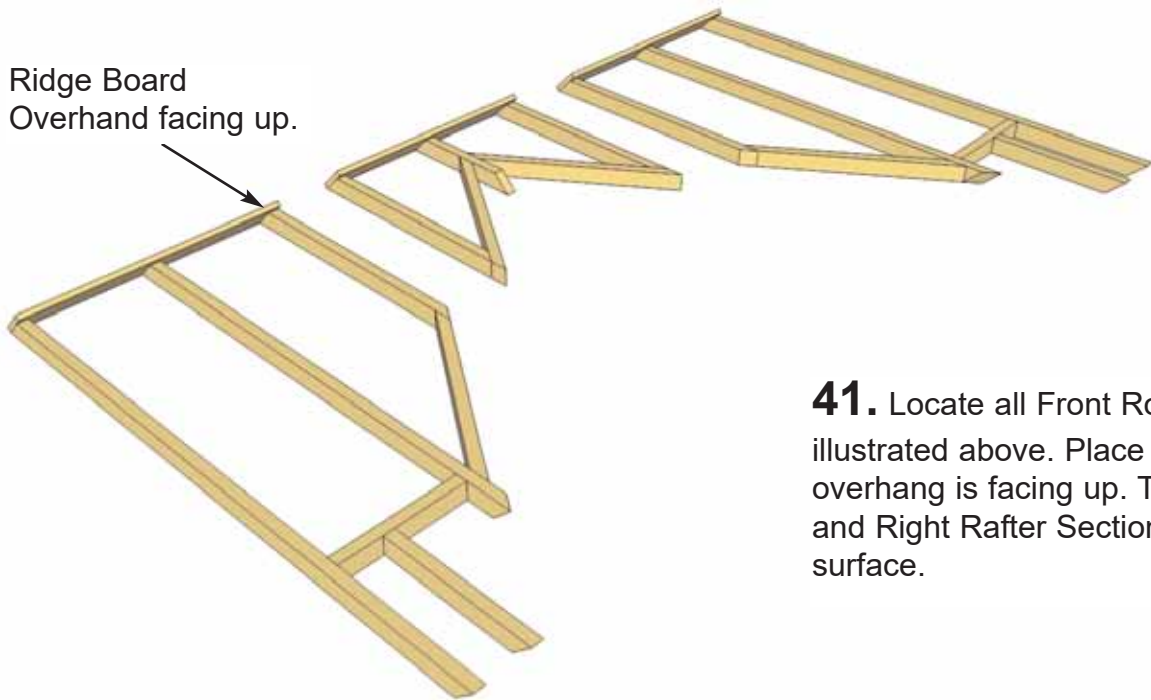

41. Locate all Front Roof Rafter Sections as illustrated above. Place so Ridge Board overhang is facing up. There is a Left, Middle and Right Rafter Section. Place on a flat level surface.

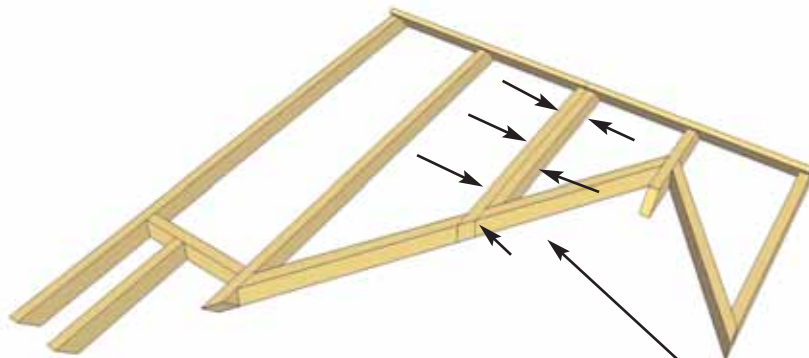

42. Position Outside and Middle Rafter Sections together so Ridge Boards and connecting rafters are flush with each other. Attach together with 6 - 2 1/2" screws.

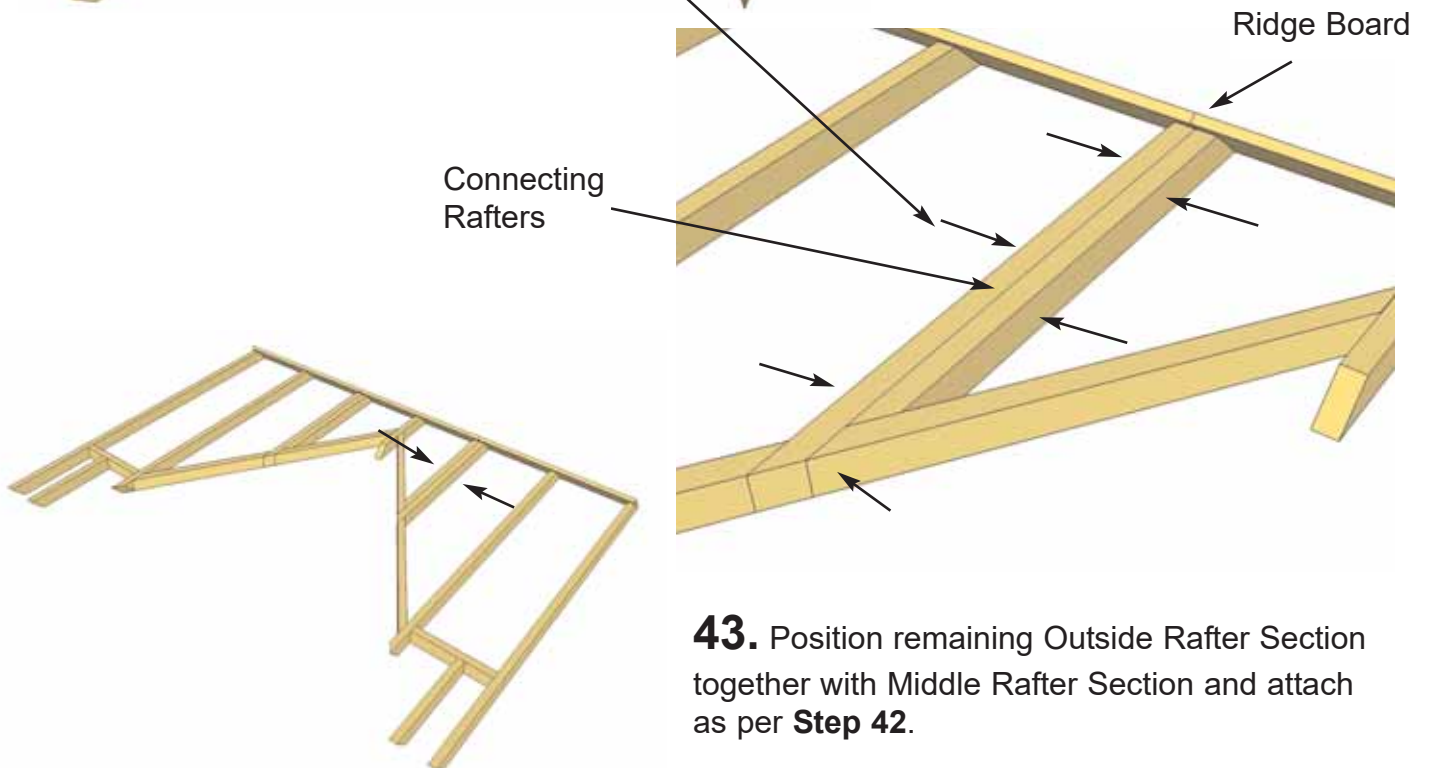

43. Position remaining Outside Rafter Section together with Middle Rafter Section and attach as per **Step 42**.

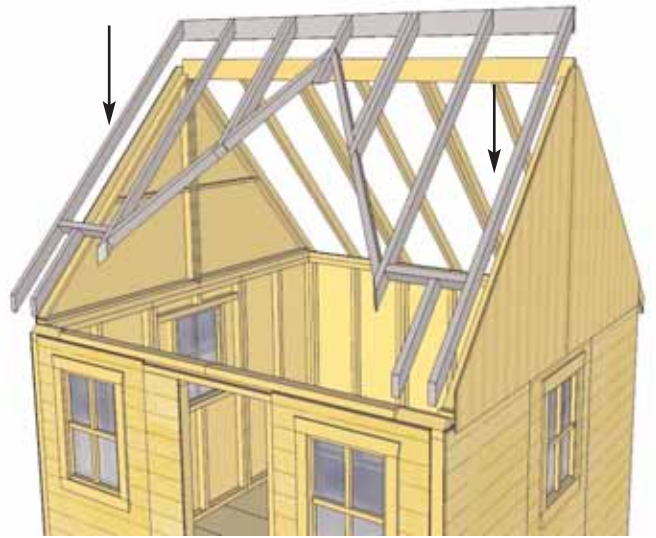

44. Carefully flip completed Front Rafter Section over and position on gable framing.

45. Position Front Rafter Section on gable wall framing. When correctly aligned, ridge board will slide into gable notch at top. Outside rafter will sit on gable framing.

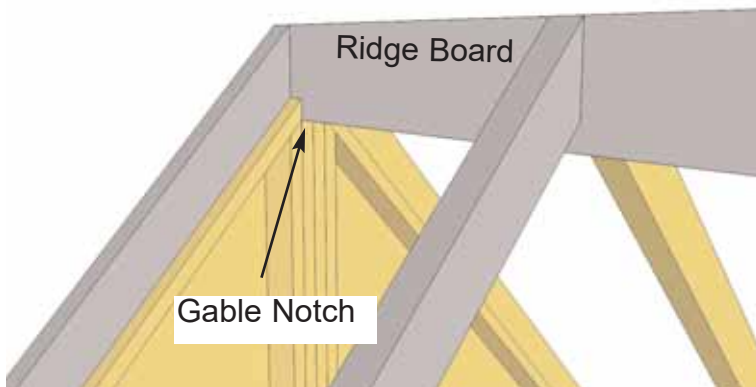
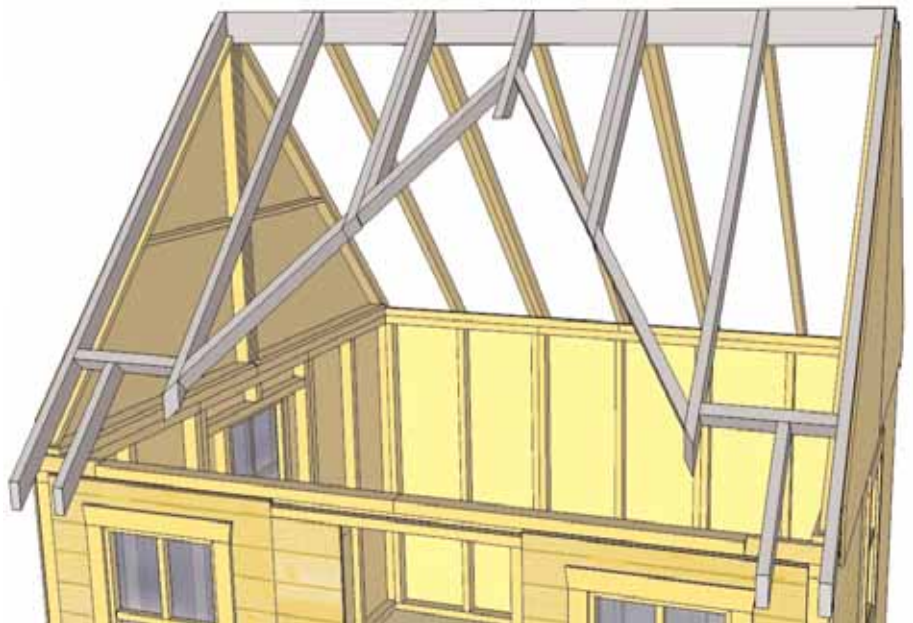

46. Ridge Board will sit in Gable Notch when Front Rafter Section is correctly aligned.



47. At the peak, align Ridge Boards so they are flush together and secure them with 12 - 1 1/4" screws. **Important-** if there is a gap between Ridge Boards, try pushing side walls closer together from outside. Walls should be 100" apart at top from inside of wall plate to wall plate.

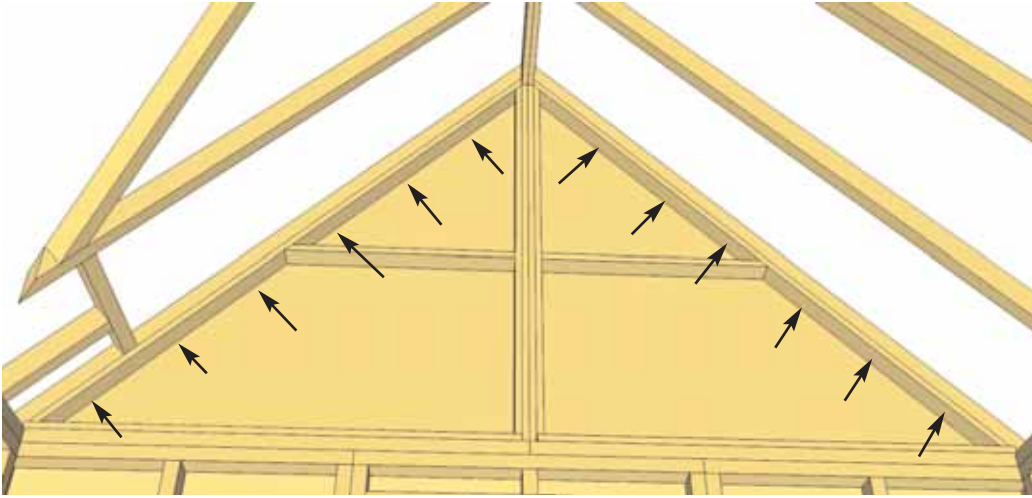

48. With both Rafter Ridge Boards connected. Completely secure Gable framing to both outside rafters with 12 - 2" screws per gable side.

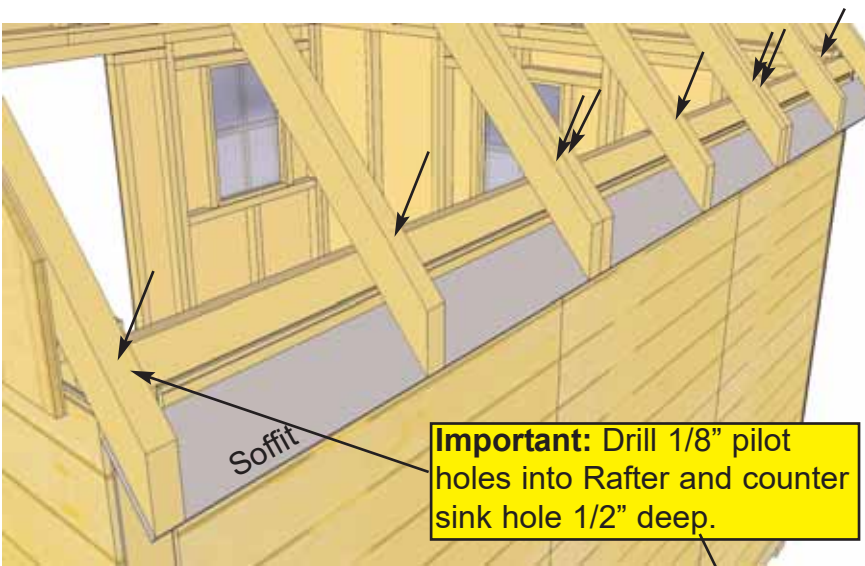

49. To further secure Rear Rafter Section, screw rafters down to rear walls near ends using 1 - 3" screw per rafter. Screw down into rafter on an angle so screw goes through Top Plate and Wall Plate.

Pilot hole Rafters with a 1/8" drill bit prior to attaching rafters with 3" screws.

Important: Drill 1/8" pilot holes into Rafter and counter sink hole 1/2" deep.

50. In the front, secure both outside rafters down to front walls near the ends using 1 - 3" screw per rafter. Complete both sides.

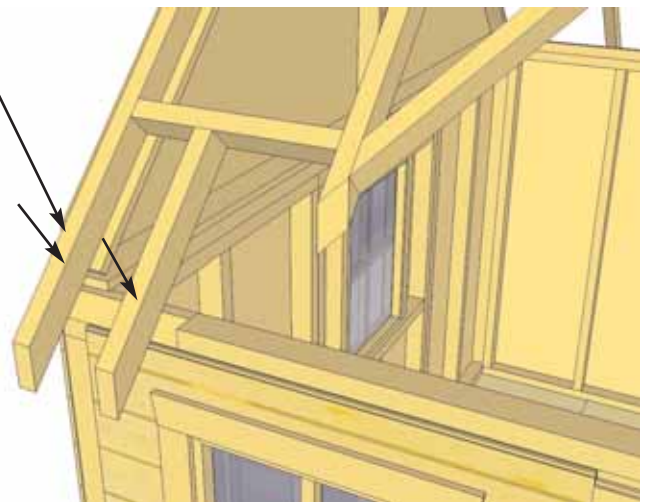

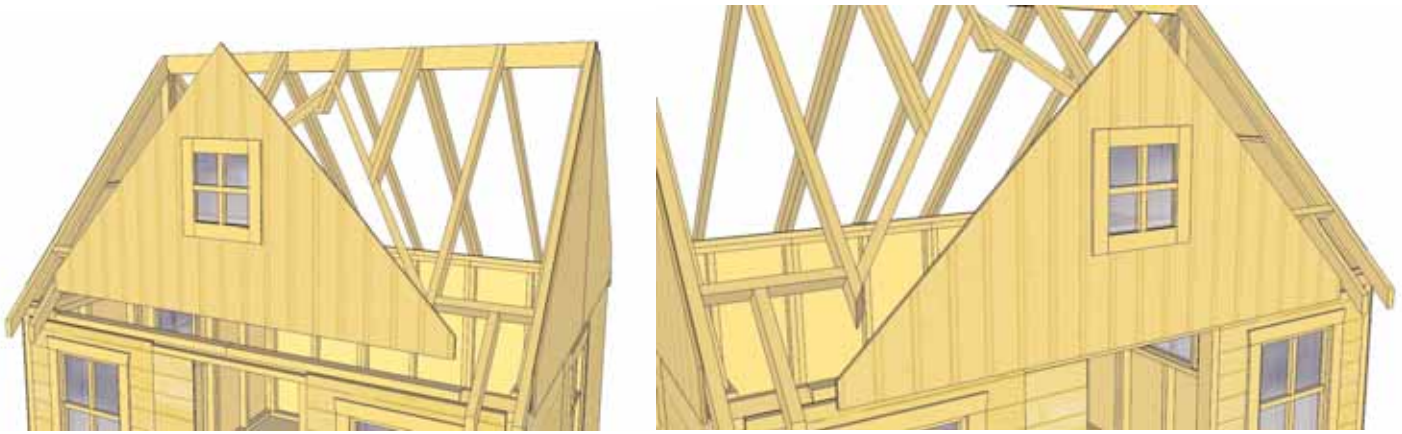

51. Lift up **Dormer Gable** and place equally from side to side on Front Top Wall Plate. Bottom Dormer Gable framing should sit flush with top plate from the inside. From the outside, Dormer Gable Siding will slightly overhang wall siding.

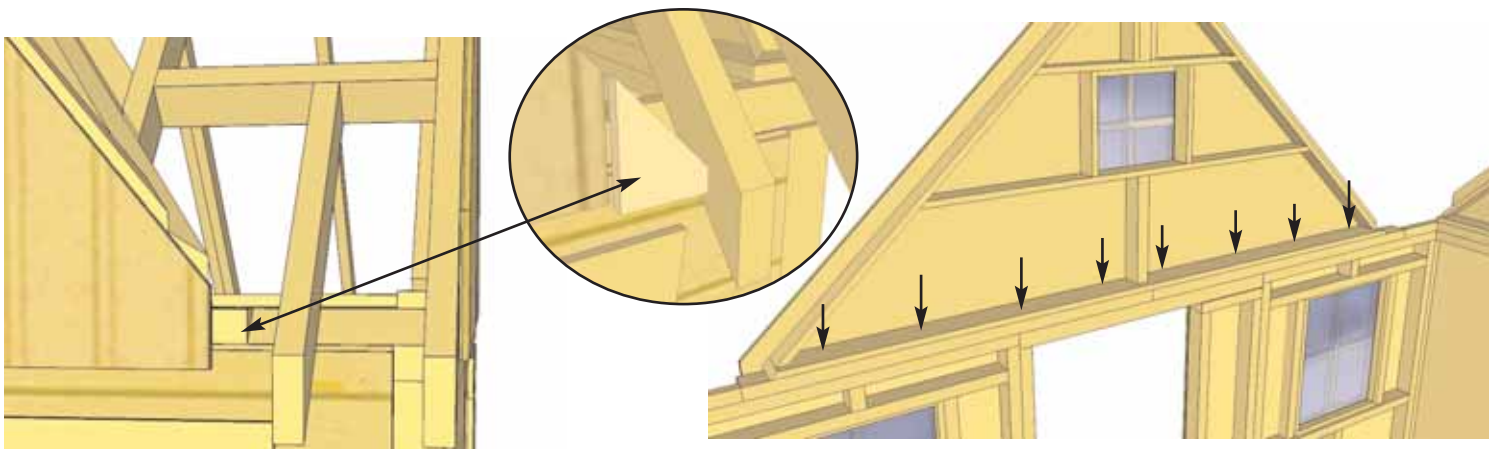

52. When correctly positioned, secure Dormer Gable frame to Top Plate with 8 - 2" screws. 2 Triangular Corner Gable Trims are included to trim out gap where Dormer Siding and Rafter meet. Use 2 - 1 1/4 finishing nails to secure each piece.

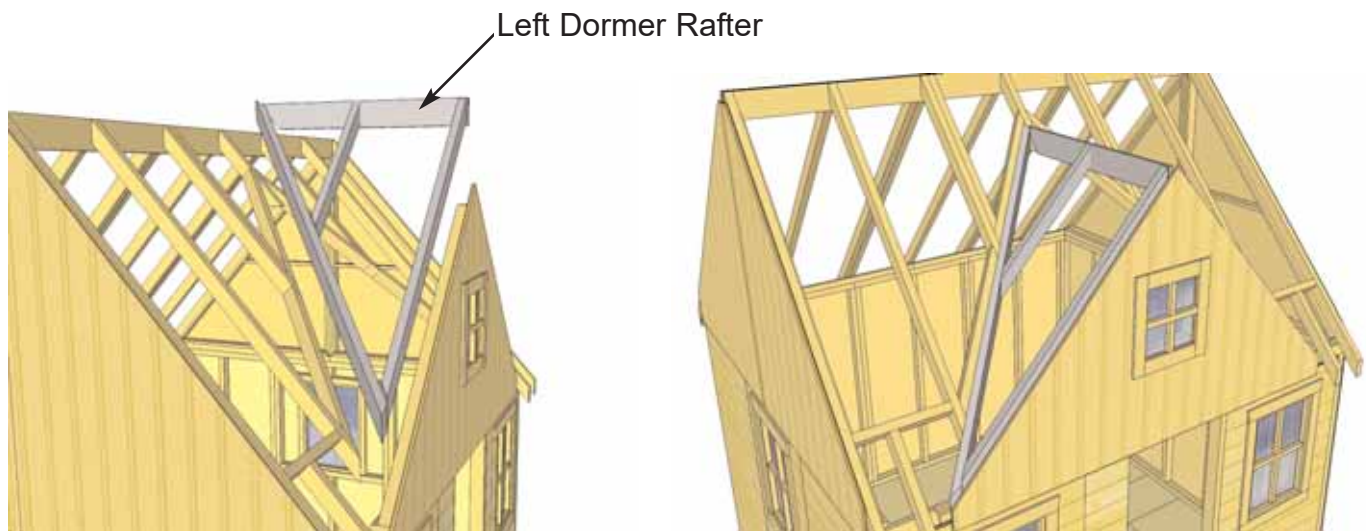

53. Locate Left **Dormer Rafter** Section and place on Dormer Gable framing.

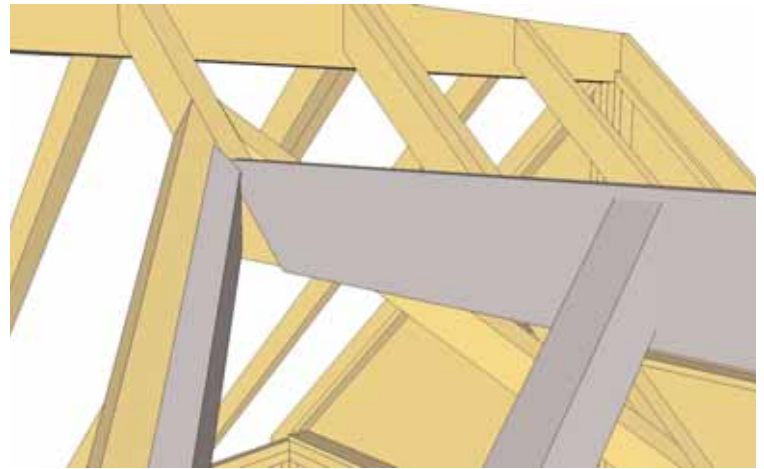
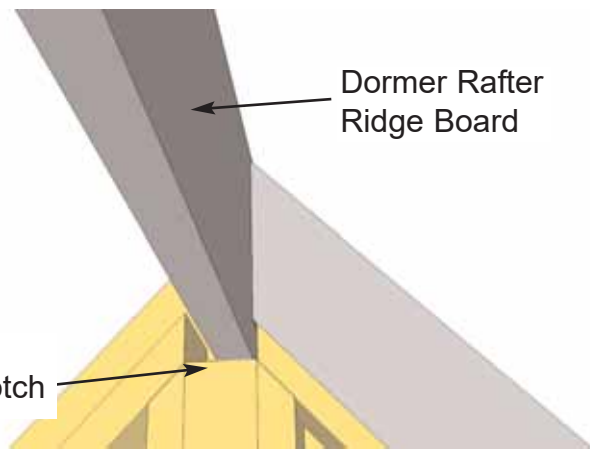

54. Place Dormer Rafter Ridge Board in Gable Notch and rafter on Dormer Gable framing. On opposite end, angle cut rafter will sit on Front Middle Rafter end.

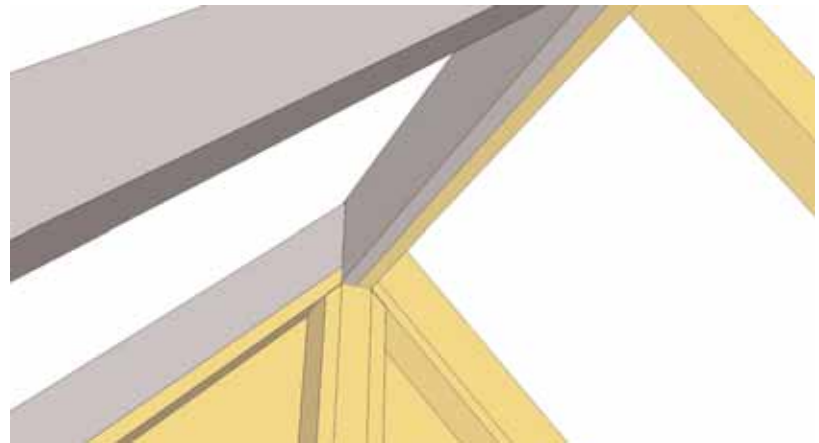
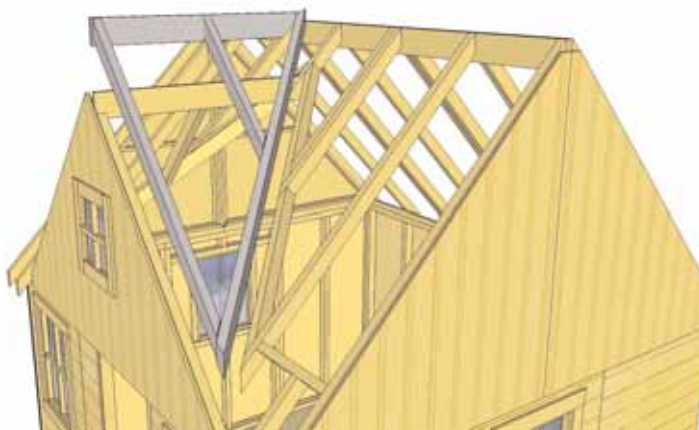

55. Place Right Dormer Rafter on Dormer Gable framing. Position Dormer Rafter Ridge Board in Gable Notch as per left side.

Level Dormer Ridge Boards

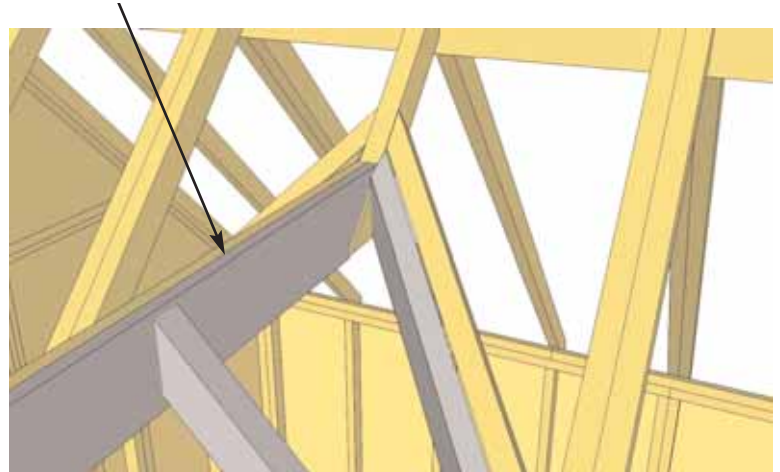
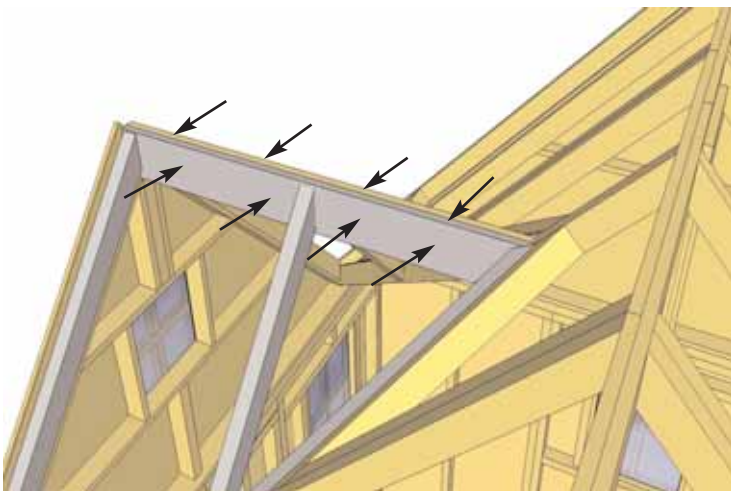

56. At the peak, align Ridge Boards so they are flush together and secure them with 8 - 1 1/4" screws. Set your Level on Dormer Ridge Board and adjust accordingly. (Angle cut ends of Dormer Ridge Board can move up or down on Front Middle Rafter to adjust to level.)

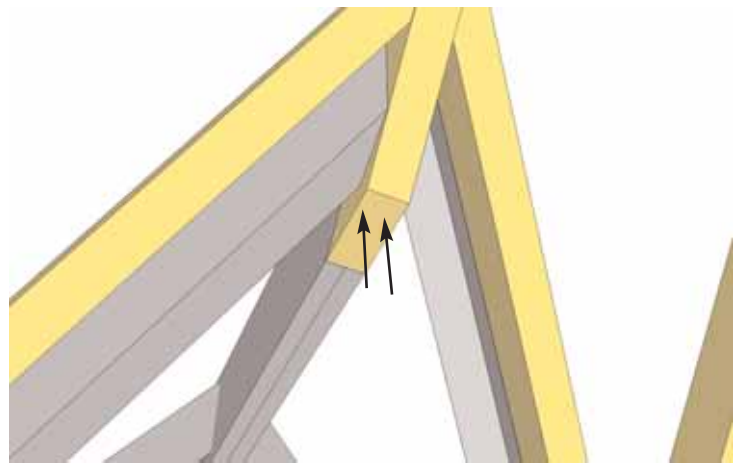
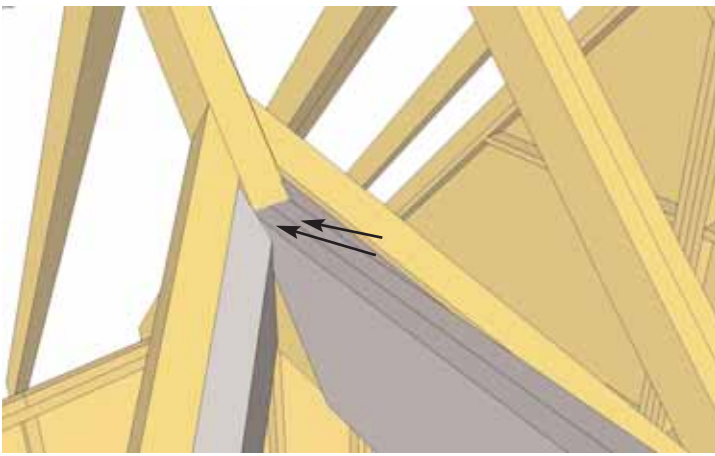

57. With ridge boards positioned correctly, attach at angle end of Ridge Board into Front Middle Rafter with 2 - 2 1/2" screws. From the bottom, further secure by toe-nailing 2 - 2 1/2" screw on angle from Front Middle Rafter into Ridge Boards. (Drill 1/8" pilot hole to prevent splitting)

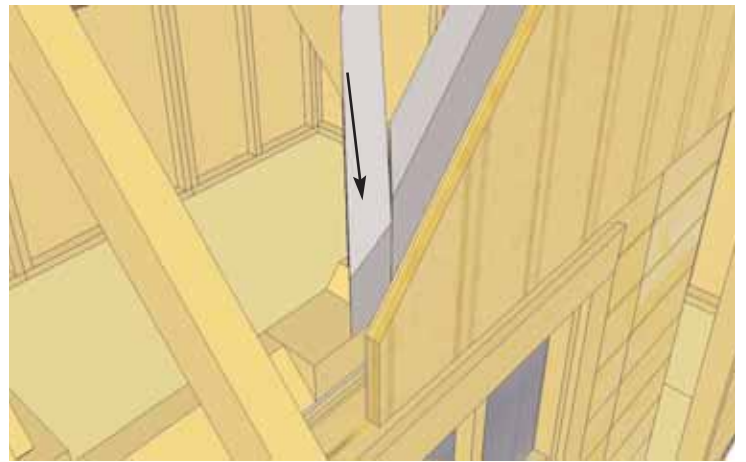
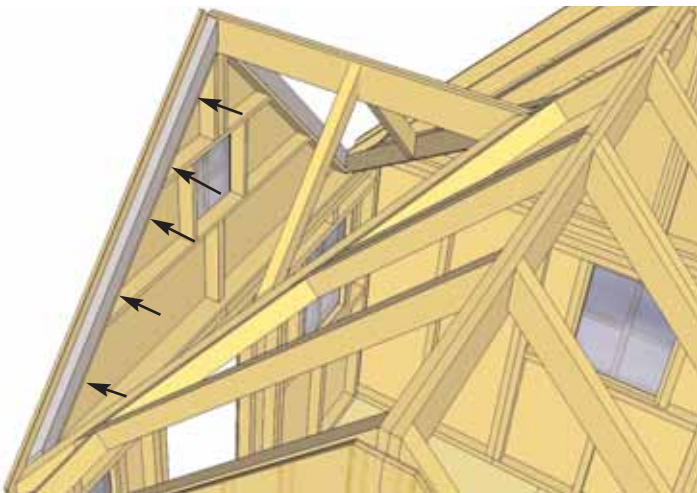

58. Secure Dormer Rafters to Dormer Gable Framing with 10 - 2" screws. (5 per side). At bottom end of Dormer Rafter, further secure rafter to Top Wall Plate with 1 - 4" screw. Complete both sides.

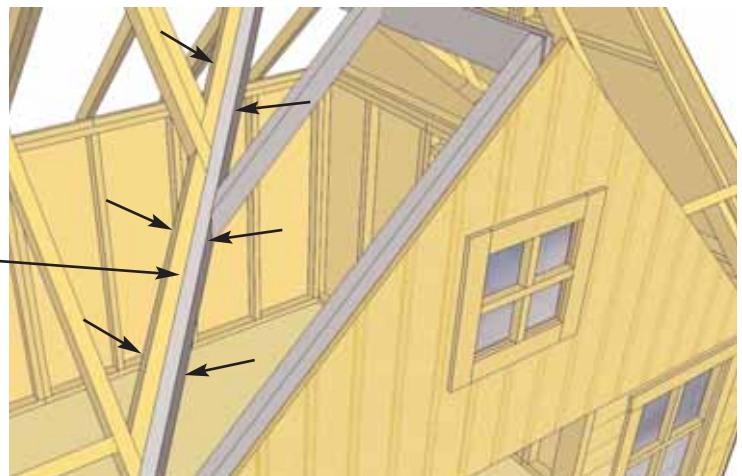
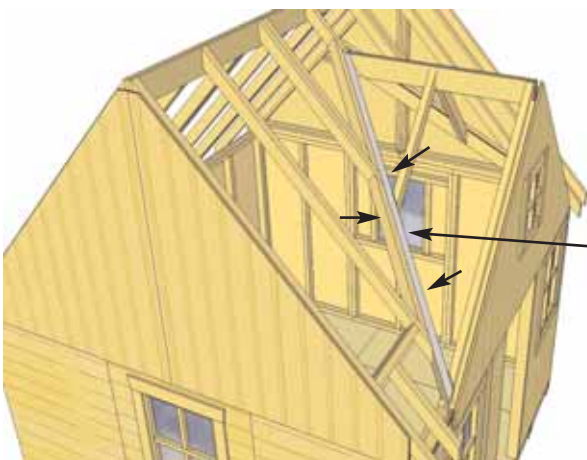

59. In dormer valley, completely secure Dormer Rafters to Front Rafter Section with with 6 - 2 1/2" screws per side.

Note, a slight gap may occur where rafters meet



60. Locate both Rolls of Flex Flashing and lay out in dormer valley. Position so it covers valley rafters near Dormer Gable and secure with 2 - finishing nails. At top, slightly fold over Dormer Ridge Boards and trim excess flashing if required. Attach with 2 - finishing nails. Complete both sides.



Plywood flush with end of rafters.

61. Locate Outside Rear Roof Panel. Outside panels will have shingles overhanging plywood roof sheathing on outside and plywood flush to inside. With your helper, place rear roof rafters so plywood sheathing is flush with end of rafter.

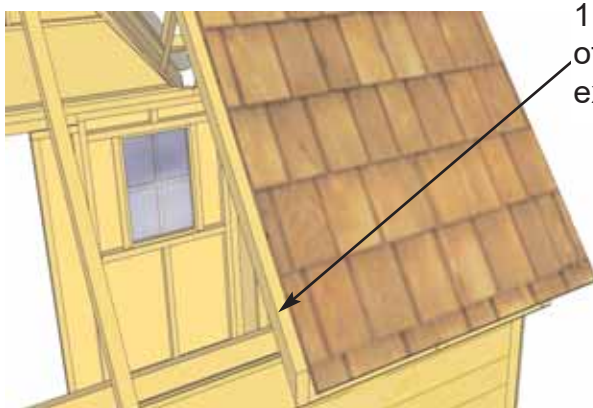

1 1/4"
of Rafter
exposed.



62. Place Outside Roof Panel so it sits on 3rd rafter from the outside (doubled up rafter). From the outside, screw down through bottom row of shingles into rafter with 1 - 2.5" screw.
Note, only secure with 1 screw on bottom left row of shingles at this point.

Important: Drill 1/8" pilot holes in each Rafter (3 per Rafter) and counter sink holes 1/2" deep
Note, from outside, push roof panel down when securing.

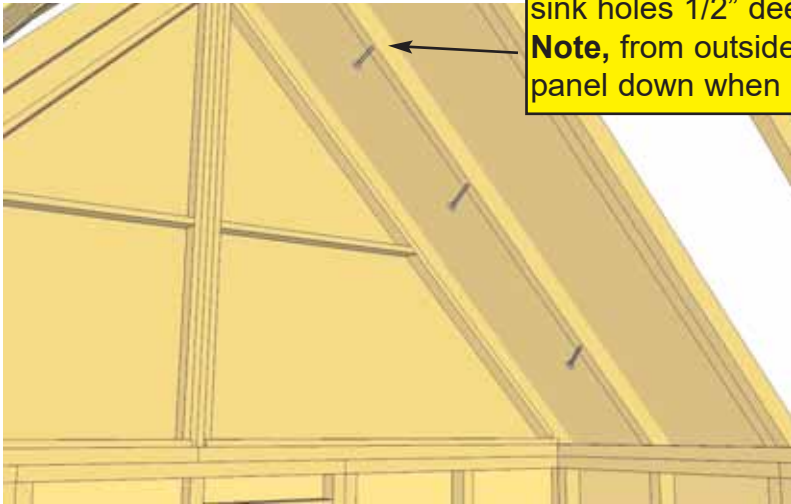

63. From the inside, further secure Roof Panel to rafter using 3 - 2.5" screws. Screw from rafter into plywood sheathing. Drill pilot holes in Rafter first.

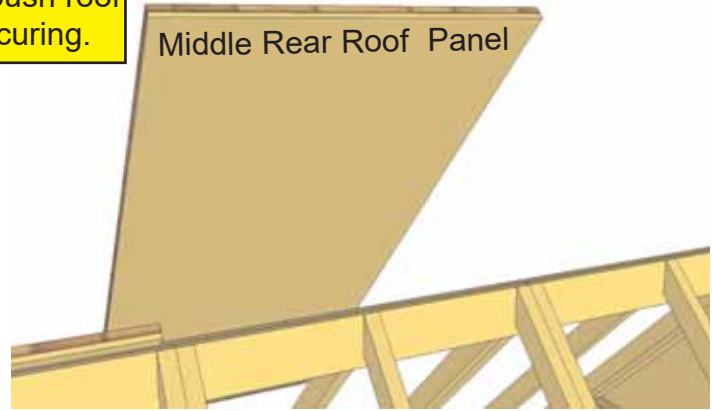

64. Locate Middle Rear Roof Panel. This panel has plywood flush with shingles on both sides.



65. Place **Middle Rear Panel** on Rafters and position as per **Step 61 - 62**. Screw down through bottom row of shingles on both sides into rafters with 2 - 2.5" screws. Further secure panel from inside as per **Step 63**.

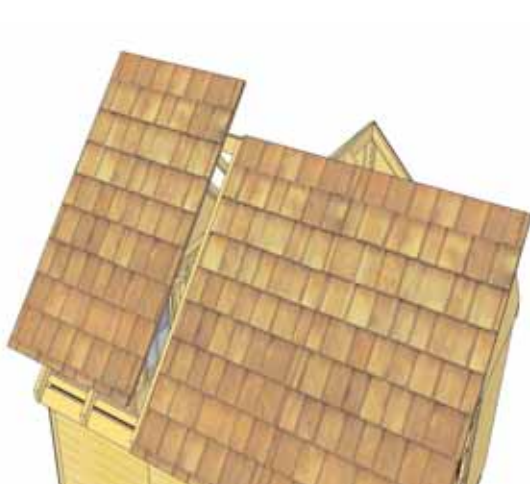

66. Place remaining Outside Roof Panel on rafters as per **Steps 61- 63**.



67. From the outside, screw down through bottom row of shingles into rafter with 1 - 2.5" screw. Secure from inside as per **Step 63**.



68. Carefully lift and place Front Left Roof Panel on front rafters.



Attach with 1 - 2.5" screw to temporarily secure roof.

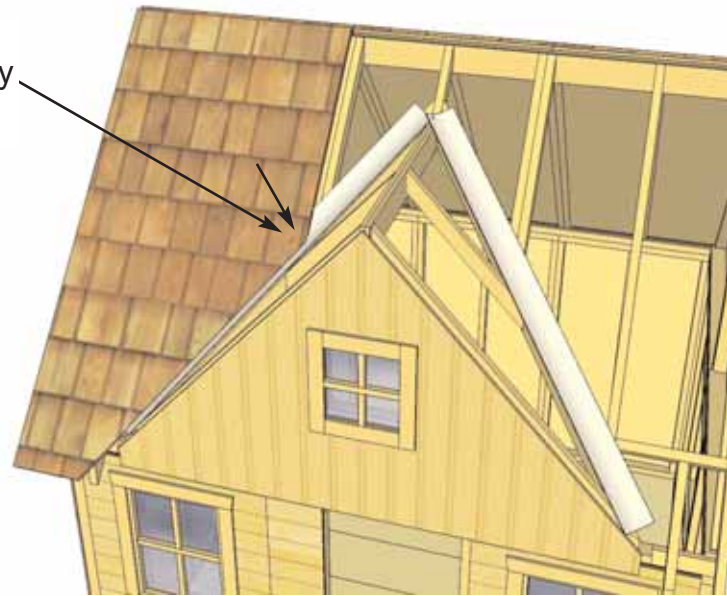

69. Position Roof Panel so plywood roof sheathing is flush with end of rafter. Make sure Front and Rear Roof Panels are overhanging Side Gables equally. Screw Roof Panel approx. 38" up (where Filler Shingle will cover) into rafter with 1 - 2.5" screw.

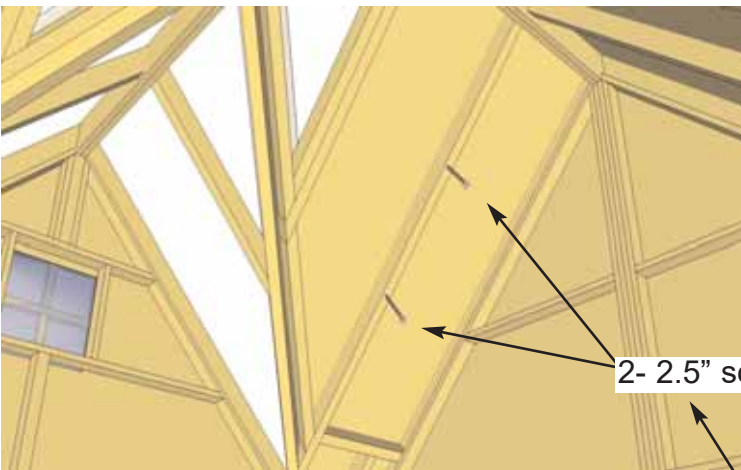

2- 2.5" screws

70. From the inside, further secure Roof Panel to rafter using 2 - 2.5" screws. Screw from rafter into plywood sheathing. Drill 1/8" pilot holes in Rafters prior to securing with screws.



71. Carefully lift and place Front Middle Roof Panel on rafters.

Important: Drill 1/8" pilot holes into Rafter and counter sink holes 1/2" deep.

Important: Drill 1/8" pilot holes into Rafter and counter sink hole 1/2" deep.

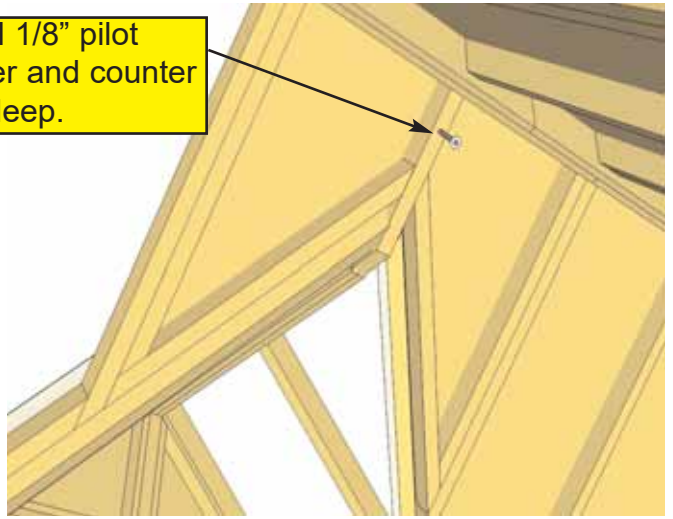
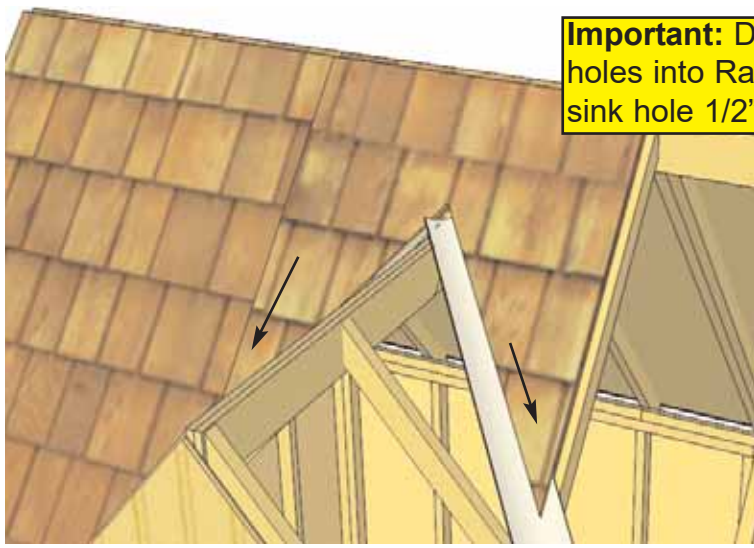

72. Screw down through bottom angle cut row of shingles on both sides into rafters with 2 - 2.5" screws. Further secure panel from inside with 1 - 2.5" screw from mid rafter into roof sheathing.



73. Lift and place Right Side Front Roof Panel on rafters. Position on rafters as per **Step 69**.

Important: Drill 1/8" pilot holes into Rafter and counter sink holes 1/2" deep.

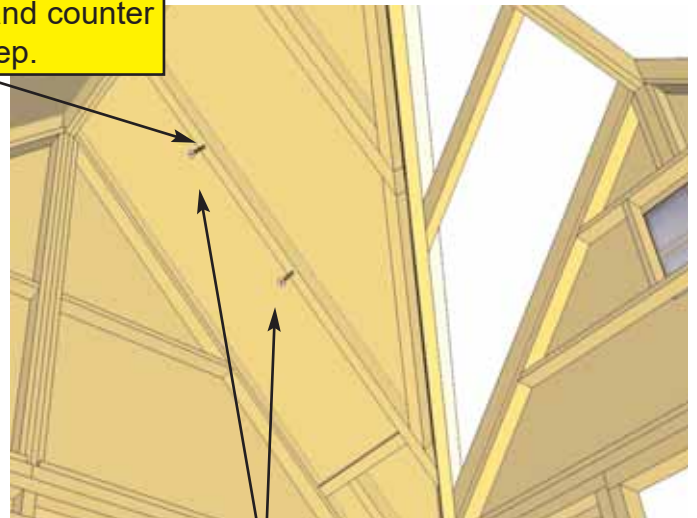

2 - 2.5" screws

74. Secure Roof to Rafters as per **Steps 69-70**.
Drill 1/8" pilots in rafters prior to securing.



75. Roof **Filler Shingles** are included to cover seams where Roof Panels come together. Starting at the bottom rear side of playhouse, slide the first 16" long shingle in until flush with other bottom shingles. **DO NOT ATTACH UNTIL STEP 76.**



Attach above the exposure line.
Exposure Line



76. Screw first Filler Shingle down to rafters using 1 - 2.5" screw per panel. Make sure to screw into rafter.

77. Slide in another filler shingle and attach as per **Step 76.** On your last row of shingles, the filler shingle is 7" long. Attach to roof with 2 - 1 1/4" shingle nails per shingle.



78. Insert Front Filler Shingles where seam of Middle and Side Roofs come together. Attach shingles as per **Step 76.** Complete both sides.



79. Locate Left Dormer Roof Panel and place on Dormer Rafters.

Roof overhanging
Dormer Gable

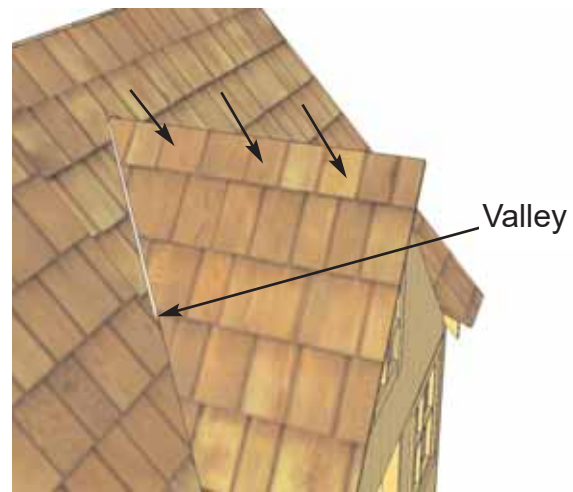
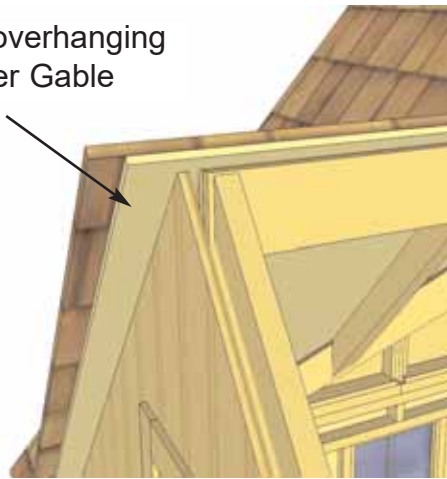

80. Position Dormer Roof Panel so diagonal end sits snug in roof valley. Roof shingles will overhang Dormer Gable. Panel should not be placed past center of Dormer Ridge Board. When correctly positioned, attach Roof panel to Ridge Board 2" down from top with 3 - 2.5" screws.

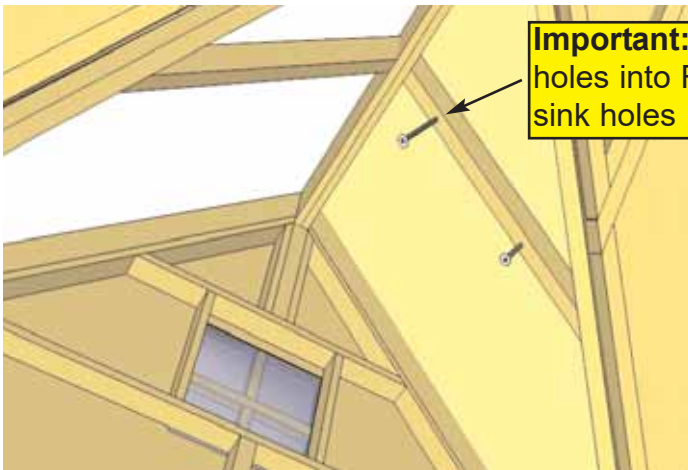

Important: Drill 1/8" pilot holes into Rafter and counter sink holes 1/2" deep.

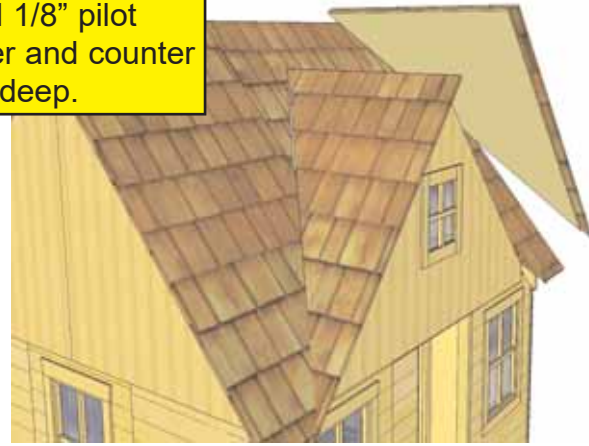

81. From the inside, further secure Dormer Roof Panel to Dormer Rafter using 2 - 2.5" screws. Screw from rafter into plywood sheathing. Lift and place Right Dormer Roof Panel into position.



82. Align and attach from the outside as per **Step 80**. Make sure both roof panels have the same overhang over Dormer Gable Prior to attaching.



83. Attach Dormer Roof Panel to Dormer Rafter from the inside as per Step 81.

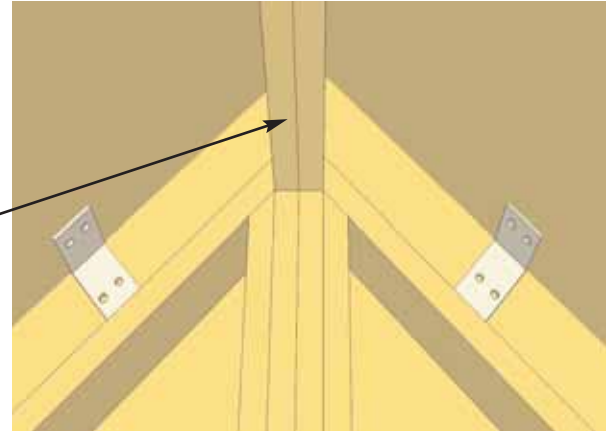
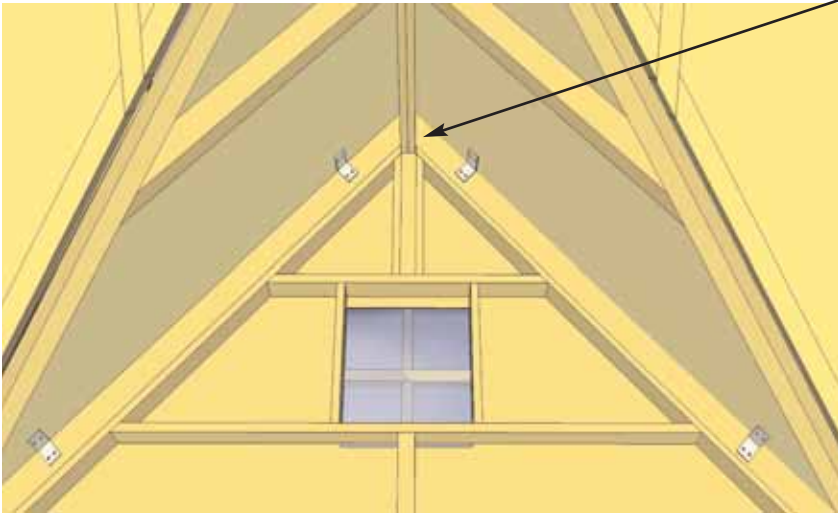

84. To further secure Roof Panels, position 2 Simpson Strong ties on outside Dormer Rafters and plywood roof sheathing. Secure each with 4 - 1 1/4" screws. There are 4 Ties for Dormer Gable.



85. To fully secure Outside Roof Panels to Gable, position 3 Simpson Strong ties on outside Rafters and plywood roof sheathing. Secure each with 4 - 1 1/4" screws. There are 6 Ties per Gable side.

D. Miscellaneous Section

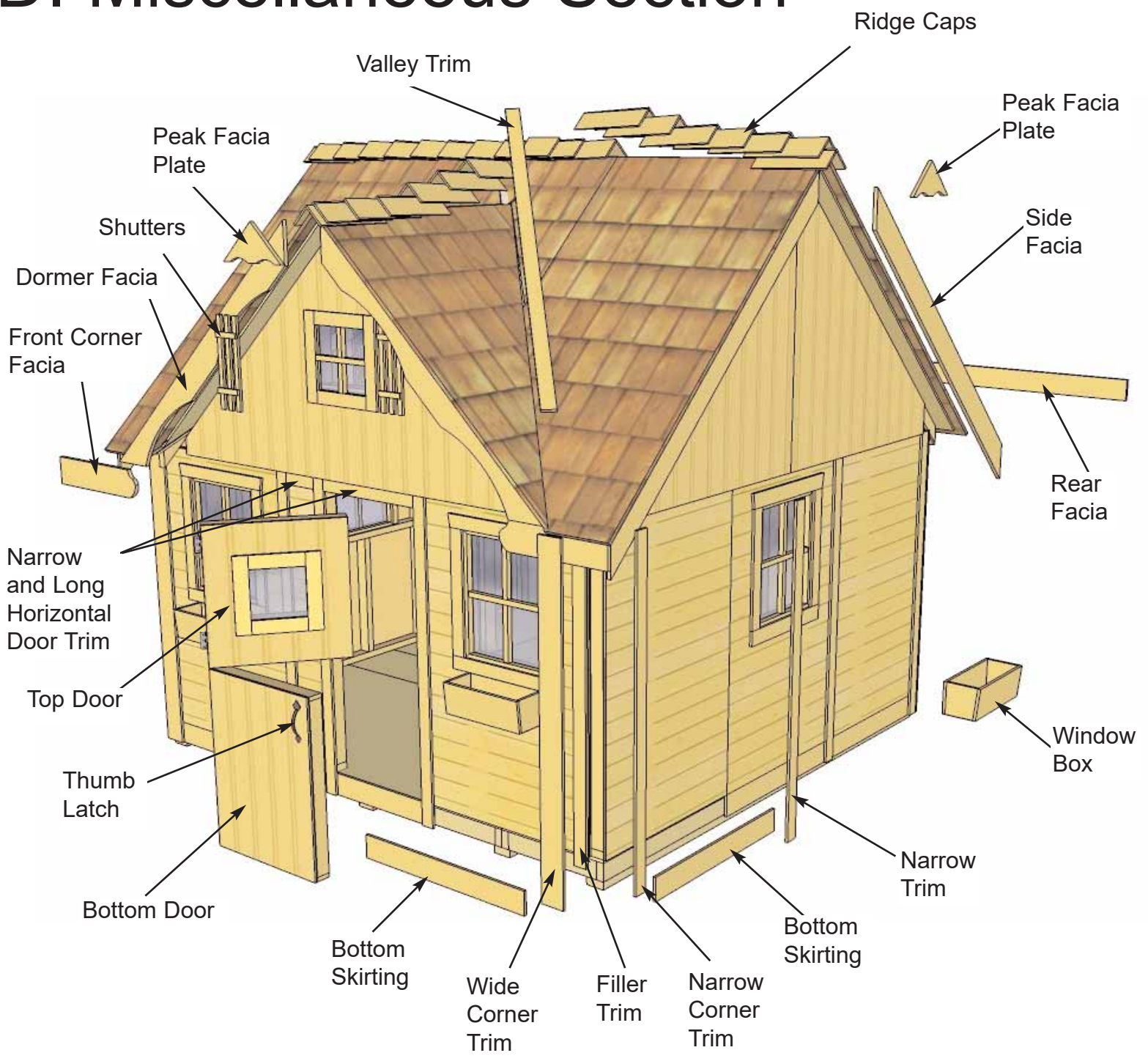

86. Attach **Front Corner Soffits** (8 3/8" long) to outside rafters. Use 4 - 1 1/2" finishing nails per side.

87. Attach **Bottom Skirting**

around the base of the playhouse. Skirting will hide floor framing. The side skirting pieces will meet together in the center. Gaps on outside will be covered by Wide Trim pieces later. Start with front and right side skirting pieces first and attach with 4 - 1 1/2" finishing nails per piece.

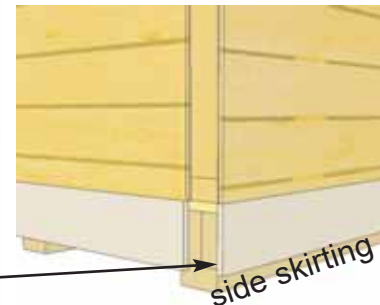
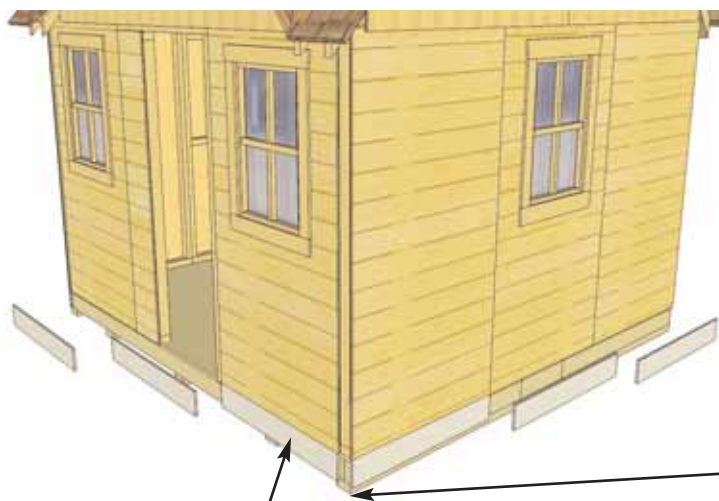

3 pieces of Bottom Skirting for front and rear.

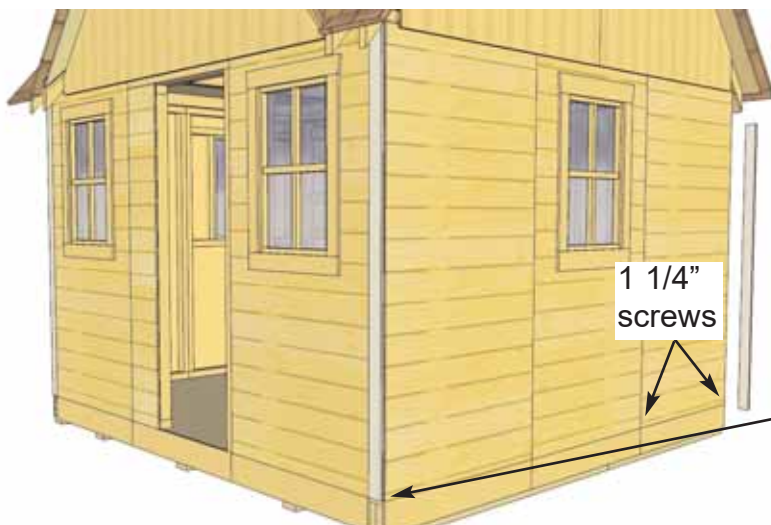

1 1/4" screws

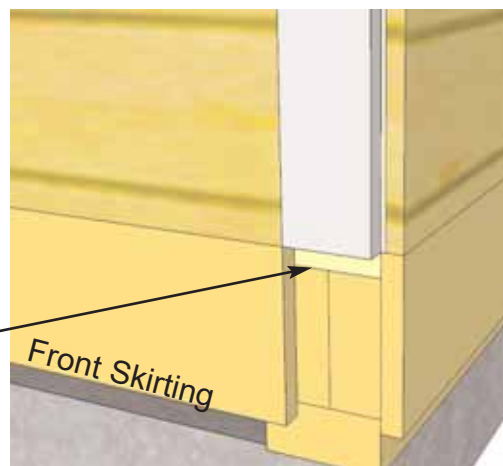

88. Attach **Filler Trims** (nailing strips) to each corner front wall. Align Filler Trims so they sit flush with top of Bottom Skirting. Hammer with 6 - 1 1/2" finishing nails per trim. Attach additional 1 1/4" screws on bottom edge of Solid Walls from wall siding into bottom wall plate to further secure bottom siding to framing.

Note, Corner Trim will cover screws in **Steps 89 & 90**. Drill pilot holes in siding to prevent splitting.

Note, Corner Trim will cover screws in **Steps 89 & 90**. Drill pilot holes in siding to prevent splitting.

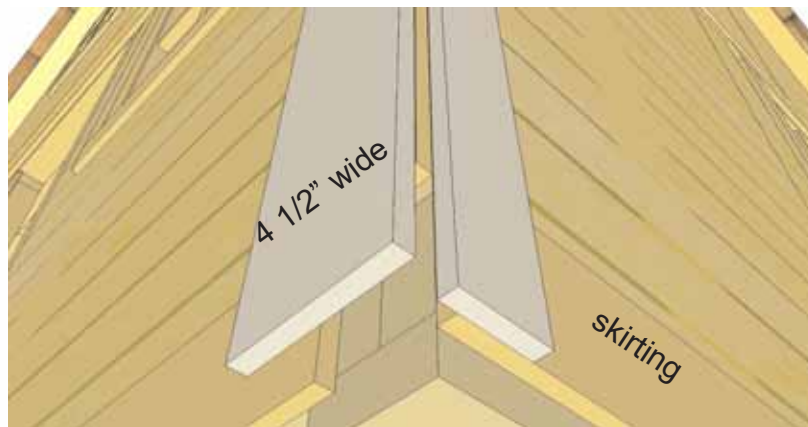

89. Attach **Wide Corner Trim and **Narrow Corner Trim** in each corner. Wide Trims are 4 1/2" wide. Narrow Trims are 2 1/2" wide. Butt Wide Trim against the back of a Narrow Corner Trim as shown in **Step 89**.**

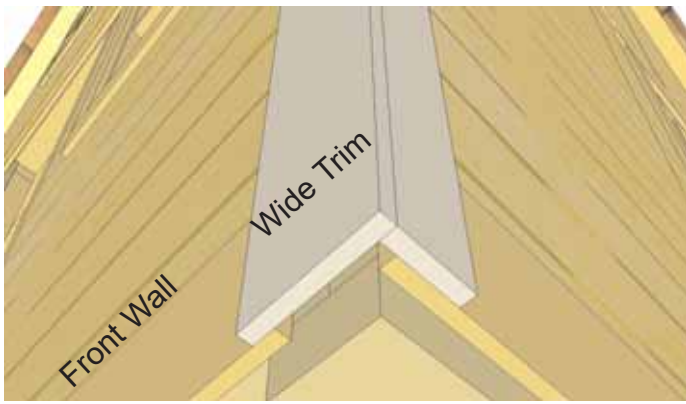

90. Position Trim flush with Bottom Skirting. At the top, trim will sit tight to bottom of Soffit. (Soffit not shown). When correctly aligned, attach with 6 - 1 1/2" finishing nails per piece.

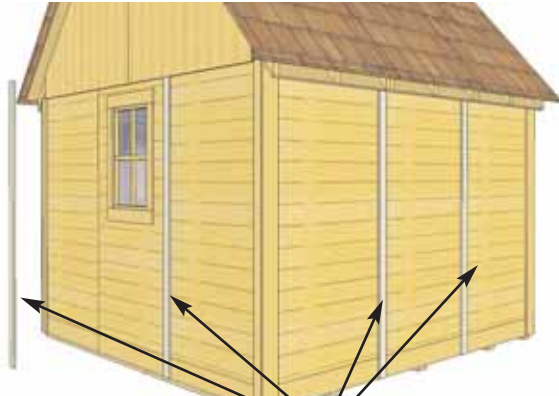

Side & Rear Wall Narrow Trim

91. Attach **Side and Rear Wall Narrow Trim (2 1/2" wide)** where wall panels come together and leave a seam. Position trim equally on wall seam and flush at bottom of Bottom Skirting. Use 6 - 1 1/2" finishing nails per piece to secure. Attach both

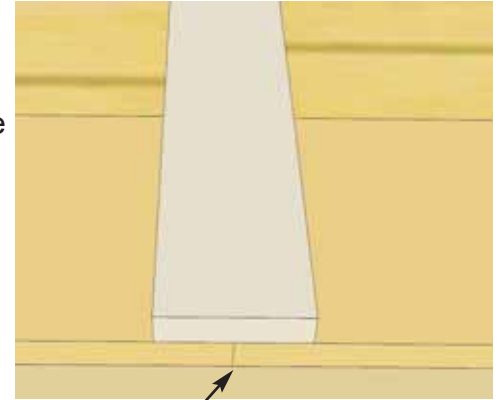

Wall Seam

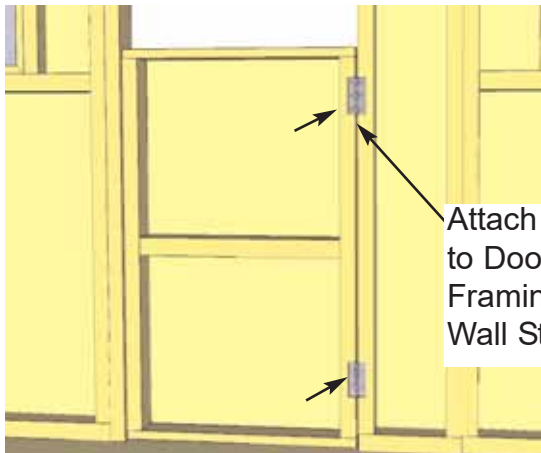

Attach Hinges to Door Framing and Wall Stud.



92. Position the Bottom Door Panel in door opening. Framing of door should be flush with wall Stud. Leave a 3/8" gap between floor and bottom door. Attach hinges with 3/4" Silver Screws for Door Hinges when correctly positioned. Follow same procedure for Top Door leaving 1/4" gap between doors. **Note**, to attach door hardware, follow instructions found in hardware kit. The bottom door has precut slot to accommodate the door handle thumb latch.



A. Line up Handle with hole. Attach with 3/4" screws.



B. Insert Thumb Piece through door hole.

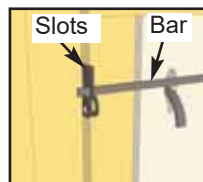

C. Line Slots and Bar. Mark location on Door and frame.

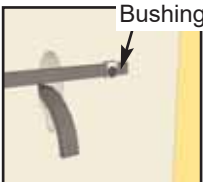

D. Attach Bar and Bushing with 3/4" screw.



E. Attach Large Slot with 2- 3/4" screws.

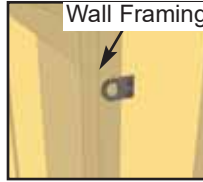

F. Attach Small Slot with 2- 3/4" screws to wall frame.

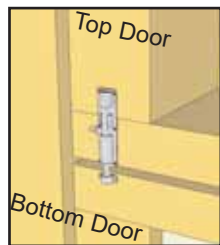

G. Attach Barrel Bolt to Top and Bottom Doors with 3/4" silver screws.

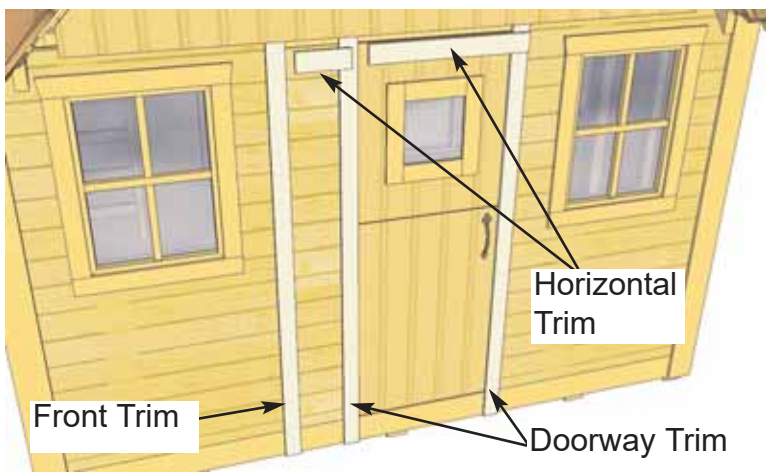

93. Position **Doorway Narrow Trims** (2 1/2" wide) over door seam. Use Horizontal Door Trim to assist with trim placement. Attach each Narrow Trim with 6 - 1 1/4" finishing nails. Attach Front Narrow Trim where seam of narrow wall and window wall come together. Attach both **Horizontal Door Trim** and **Horizontal Narrow Wall Trim** with 4 and 2 - 1 1/2" finishing nails to complete.



94. Attach **Side Facia** (angle cut on ends) to end of plywood roof sheathing. Line Facia up to form a peak and attach with 5 - 1 1/4" screws per piece. End of Facia should be aligned flush with end of rafter. Gap where facia boards come together at peak will be covered in **Step 95**. Do a dry run using the Corner and Rear Facia to help you correctly position Side Facia. Complete both sides.

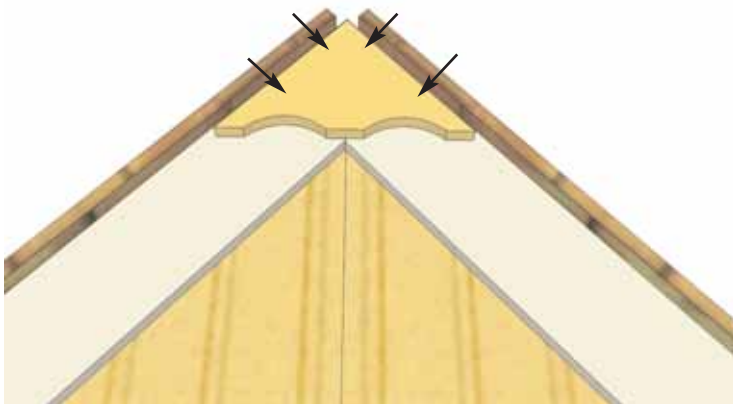

95. Attach Peak Plates to Facia with 4 - finishing nails. Complete both sides.

96. Attach Rear Facia to rafter ends with 5 - 1 1/4" screws.



97. Complete positioning and attachments of both Rear Fascia pieces. To cover seam where Fascia's meet, attach a Fascia Detail Plate with 4 - 1 1/2" finishing nails.

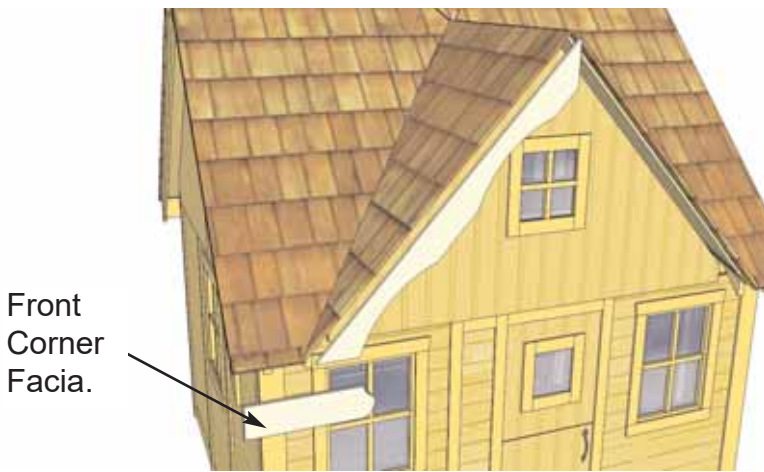

98. Locate both Dormer and Front Corner Fascia pieces. Position and secure Dormer Fascia to the end of the Dormer Roof plywood roof sheathing. Use Front Corner Fascia to assist you in setting up both Fascia pieces. When correctly aligned, attach Dormer Fascia with 5 - 1 1/4" screws.



99. Attach Front Corner Fascia with 2- 1 1/4" screws. Complete remaining fascia pieces as per Step 98.



100. Attach Peak Plate to Dormer Fascia as per Step 95.

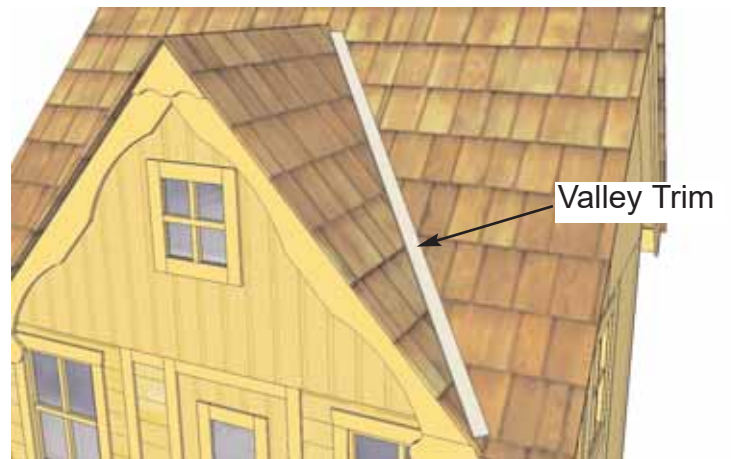

101. Position Valley Trim where Front and Dormer Roof Panels meet. Attach with 3- 2 1/2" screws per piece. Complete both sided.

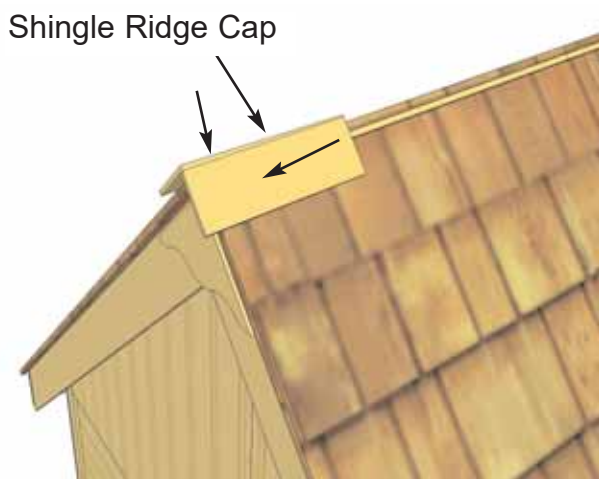

102. Place First Roof Ridge Cap on roof peak overhanging shingles by approximately 1". Attach with 2 - 1 1/4" shingle nails. Place 2nd Cap recessed 1" from 1st Cap and attach 9" from end with 2 - shingle nails. (There are left/right Ridge Caps, alternate each Ridge Cap as you proceed).

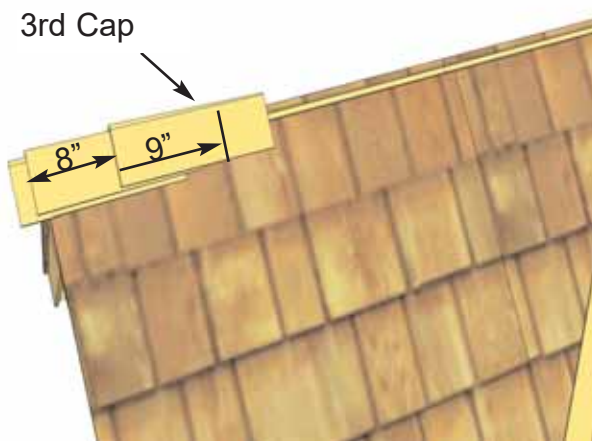
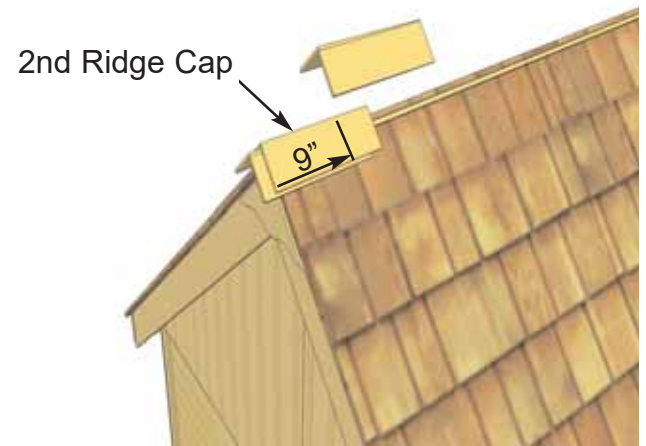

103. Attach 3rd cap as per Step 102. Complete approximately half of roof following same procedure. Start from opposite side and complete remaining half working toward the center.

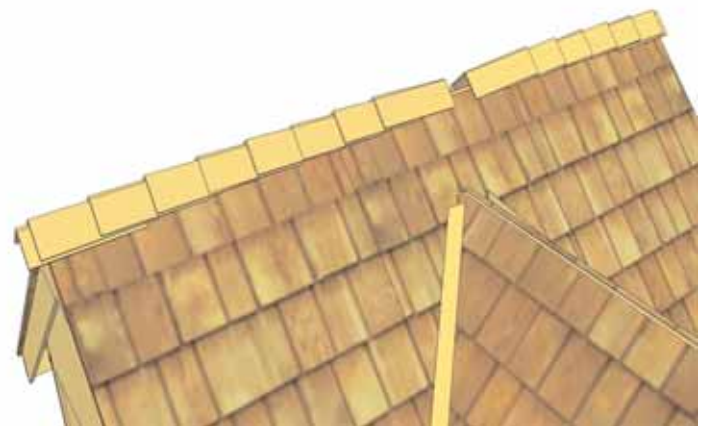

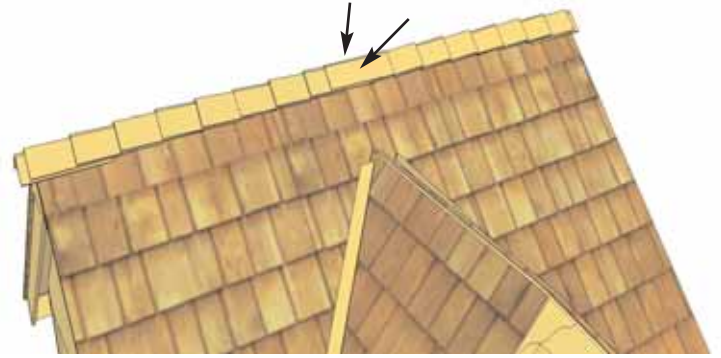
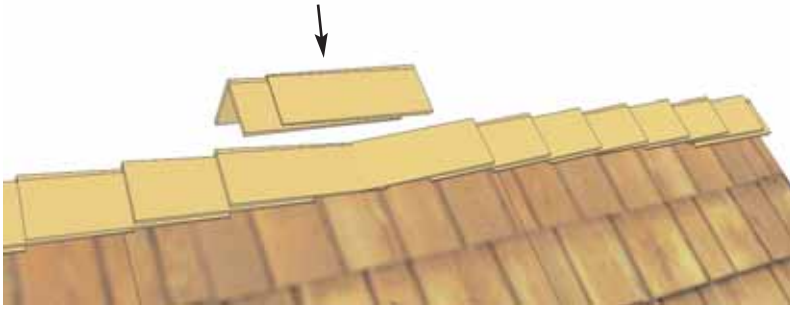

104. At center, place Ridge caps and attach with 4 - shingle nails.

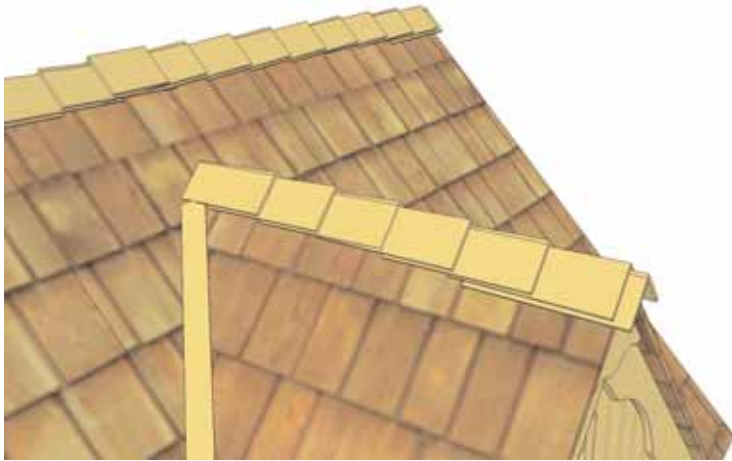

105. Complete Ridge Caps for Dormer Roof as per **Steps 102-103**.

106. Attach Dormer Window Shutters with 2 - 1 1/4" screws per shutter.

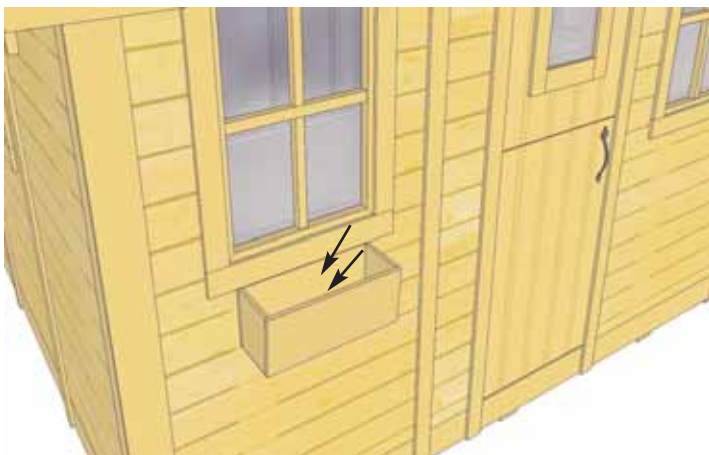

107. Assemble **Flower Box Kit** with Assembly Instructions included. Position completed Flower Box below bottom of window trim and secure with 2 - 2" screws per box. Screw from inside of box into the center wall stud. Attach second screw 2" underneath first screw and once again into the wall stud.

E. Loft Section

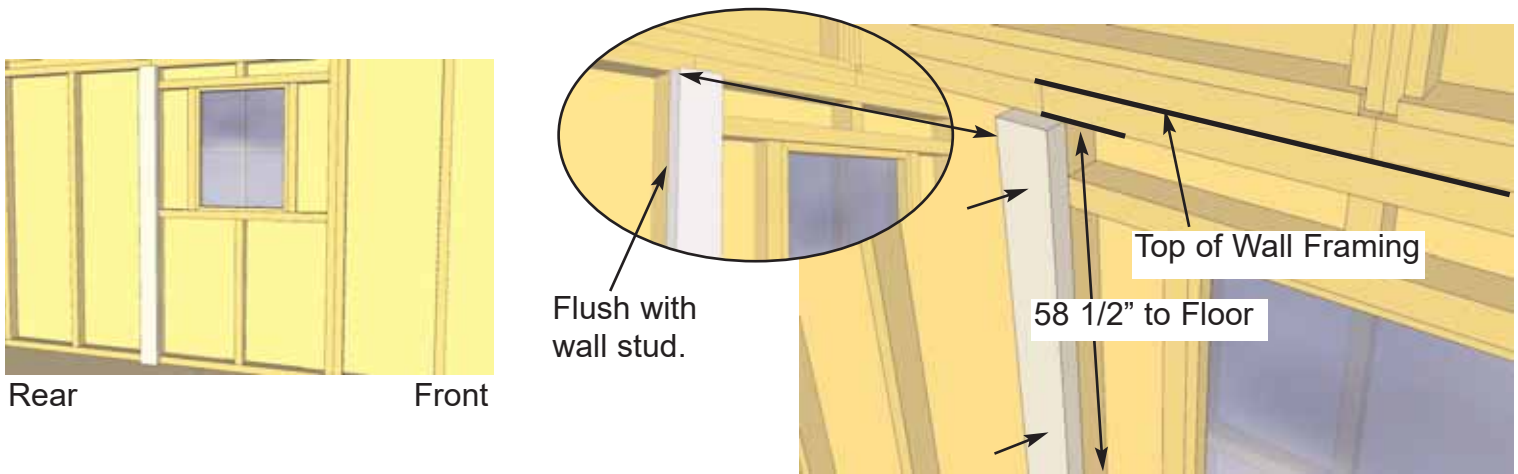

108. Locate both Loft Floor Support Posts (58 1/2" long). Position flush on wall stud. Attach with 4 - 2 1/2" screws per Post.

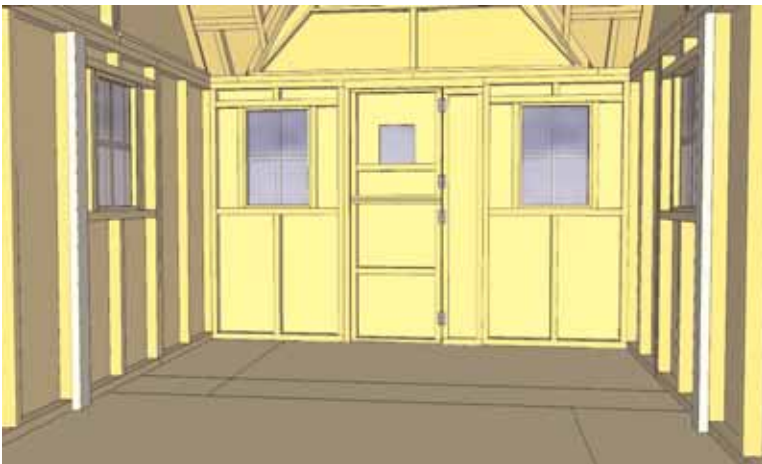

109. Complete attachments of both Loft Floor Supports as per **Step 108**.

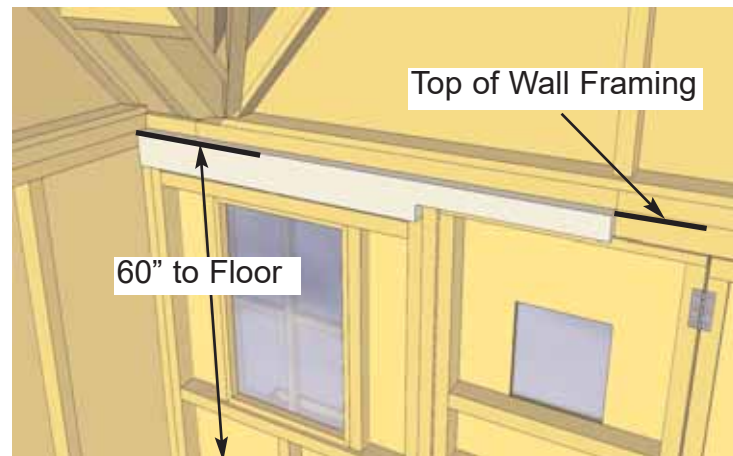

110. Locate Front Support Joists (Notched for Doorway) and attach 60" from floor to top of plate with 8 - 2 1/2" screws



111. Complete attachments of both Front Support Joists as per **Step 110**.

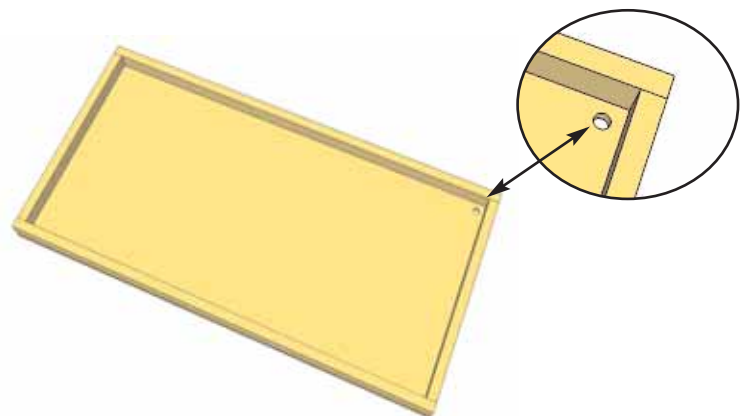

112. Locate Loft Floor with hole drilled in one corner.

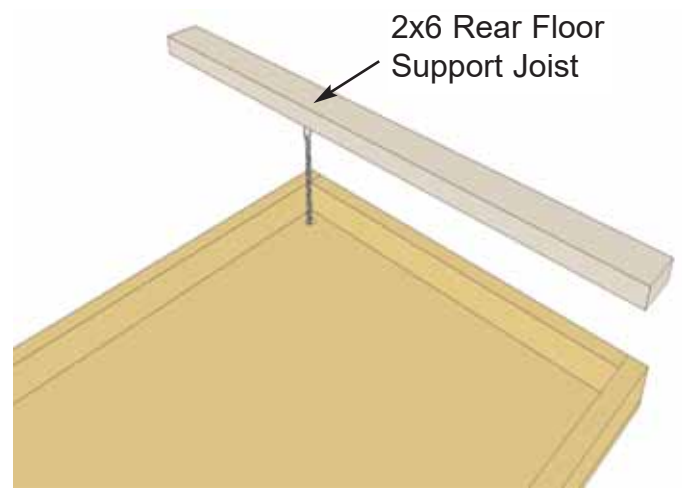
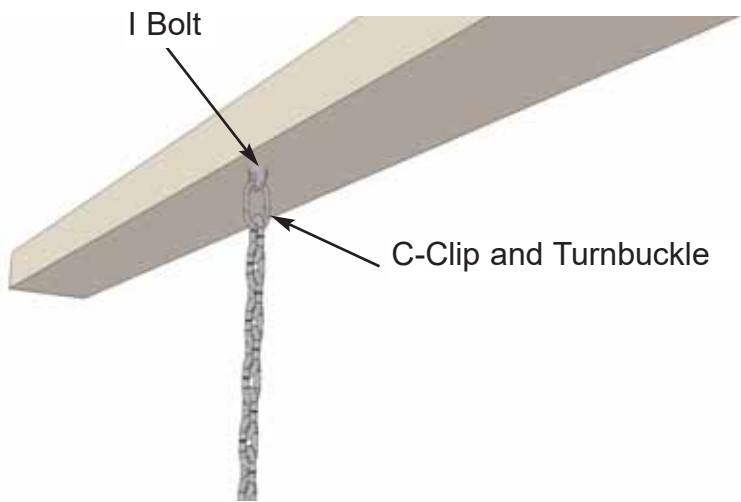

113. Locate Rear Support Joists (Pre-drilled holes in 1 end) and Loft Chains with C-Clip and Turnbuckle already attached. Slide I Bolt through hole and tighten with bolt to Joist. Attach C-Clip to I Bolt and pull Chain through hole in Loft Floor.

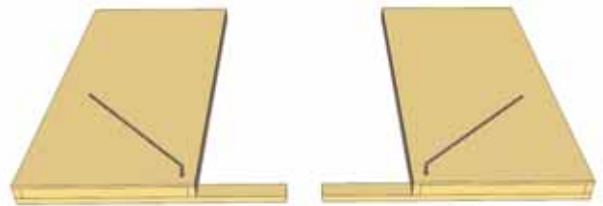
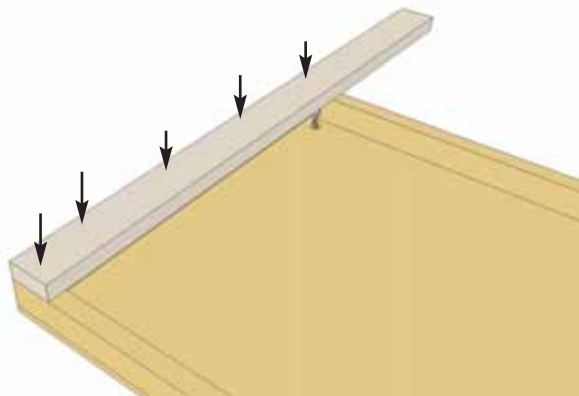

114. Attach Rear Support Joist to outside framing of Loft Floor with 2 1/2" screws. Complete both outside Loft Floors now.



115. Lift one Outside Loft Floor Section up and place on Front Support Joist and Loft Support Post.



116. Make sure Loft Floor is sitting on Front Support Joist and Loft Post.

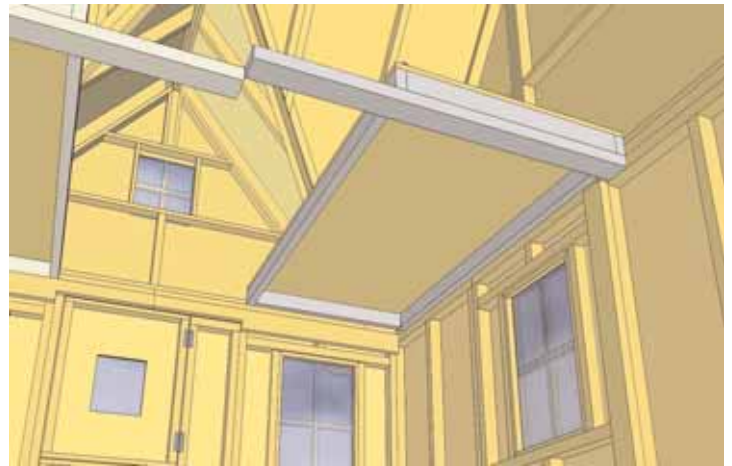
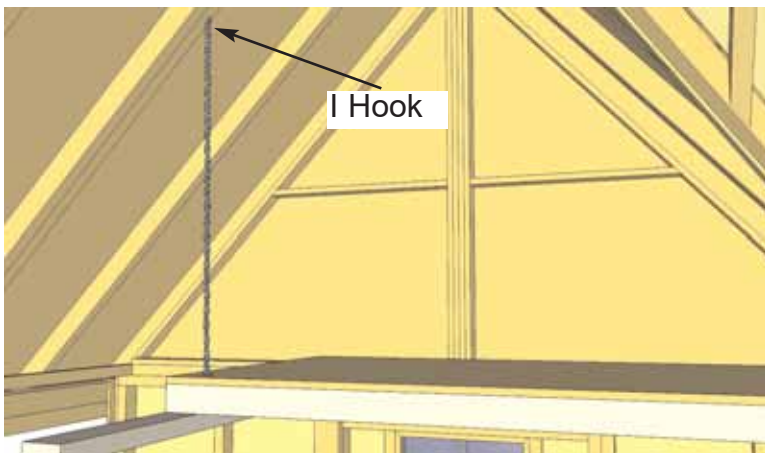

117. Locate I-Hook and screw into Roof Rafter above Loft Floor. Position Chain on I Hook. Position 2nd Outside Loft Floor on Front Support Joists and Loft Post as per **Step 116**.

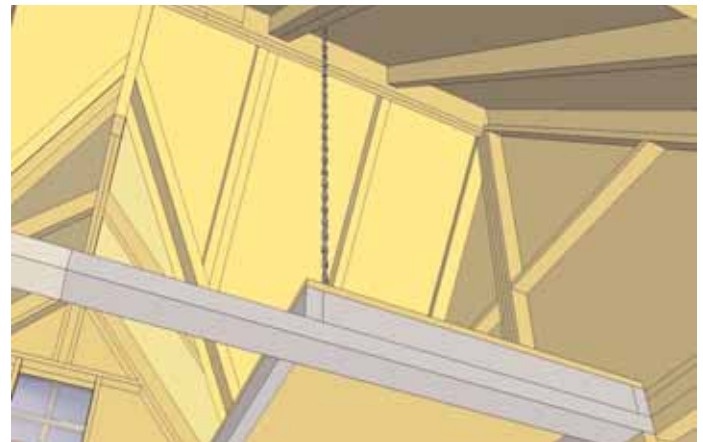

118. With 2nd Outside Loft correctly in place, screw I-Hook into Roof Rafter above and position Chain on I Hook as per **Step 117**.

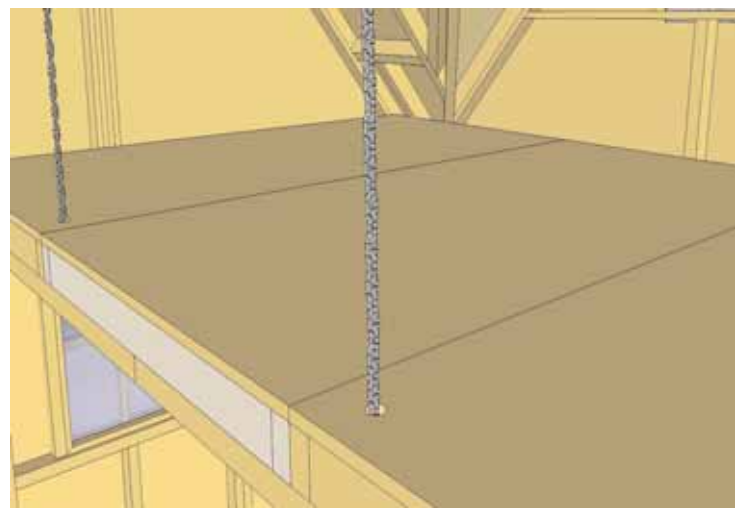

119. Locate Middle Loft Floor (No Hole Drilled in Floor) and position between Outside Loft Floor Sections. Use Level and adjust Loft Floor by adjusting Chain Turnbuckle.



120. With Loft Floor correctly aligned and positioned, attach all framings together with several 2 1/2" screws. Attach Rear Floor Joists to Middle Loft Floor Section with 4 additional 2 1/2" screws.

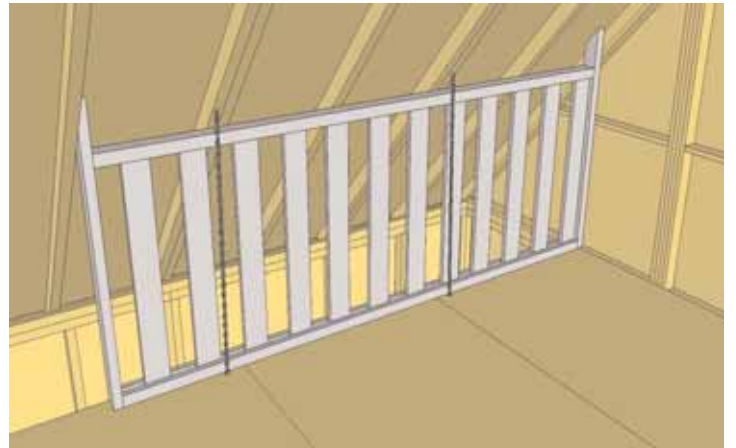

121. Lift and place Safety Railing on Loft Floor. Decide what side you prefer Ladder placement and position Railing accordingly.

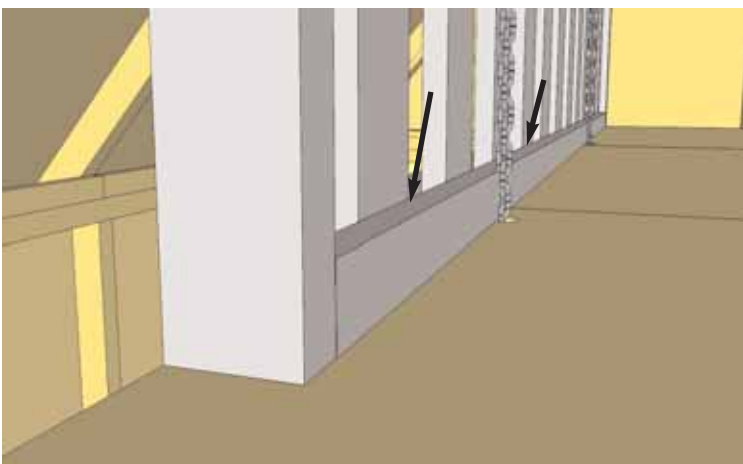

122. Attach bottom of Railing to Loft Floor with 6 - 2 1/2" screws. Attach Railing Post to Gable Framing with 2 - 2 1/2 screws.

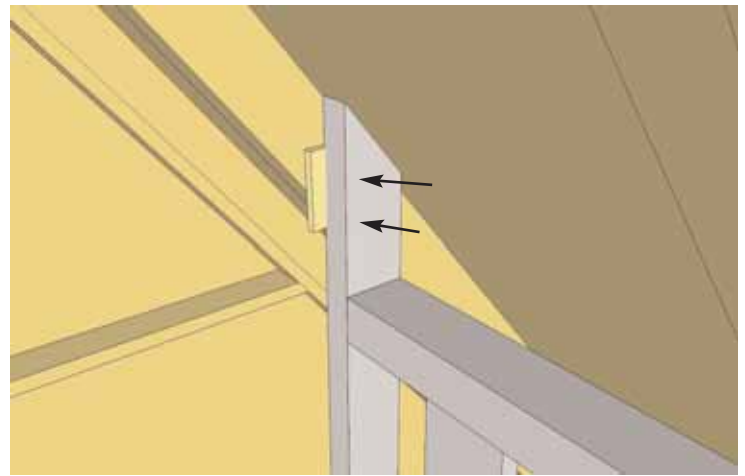

123. On the Ladder side, attach Railing Post to Rafter with 2- 2 1/2" screws. If a gap exists between Rafter and Railing Post, use shim first to fill in the gap and then secure to Post to Rafter.



Completed Safety Railing



124. Locate Ladder and position inside the playhouse in loft opening.

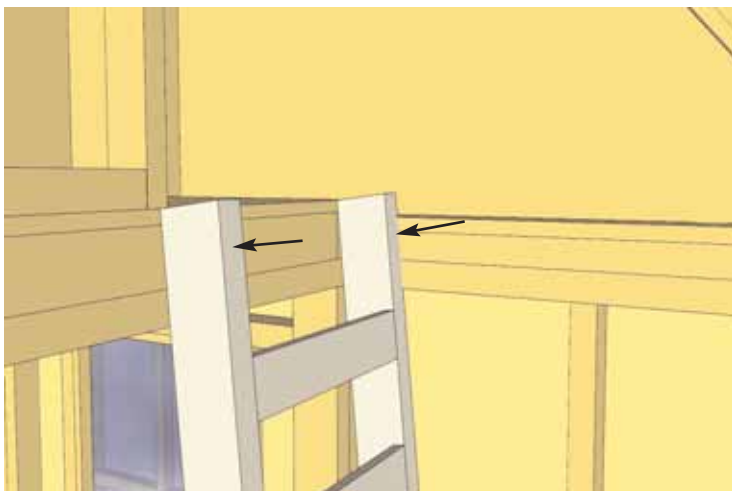

125. Using 2 - 4" screws, attach the top of the Ladder to Loft Floor. Attach bottom of Ladder to main Floor with 2 - 2 1/2" screws. Be sure to pilot holes the Ladder before securing any screws.

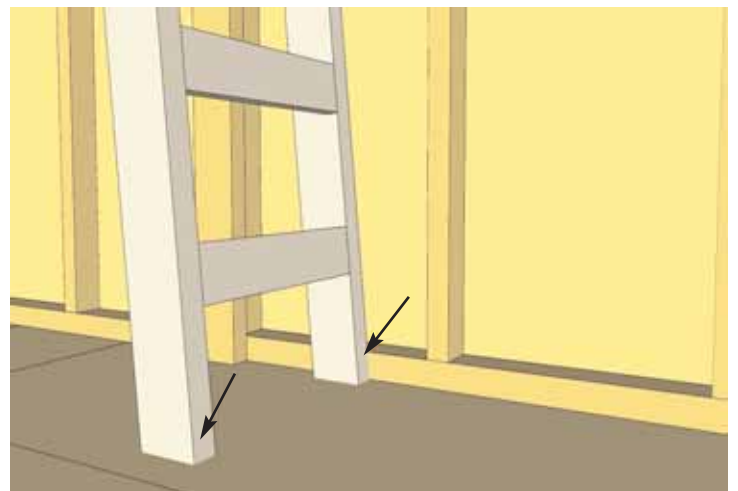



We hope your experience constructing our building has been both positive and rewarding.

We value your feedback and would like to hear back from you on how well we are doing in the following areas:

- 1. Customer Service**
- 2. On Time Shipping**
- 3. Motor Freight Delivery**
- 4. Quality of Materials**
- 5. Assembly Manual**
- 6. Overall Satisfaction.**

Please call, write or email us at:

Outdoor Living Today

Canadian Address
9393 287th Street
Maple Ridge, British Columbia
Canada V2W 1L1

United States Address
P.O. Box 96
Sumas, Washington
USA 98295



The materials contained in this Assembly Manual may be downloaded or copied provided that ALL copies retain the copyright and any other proprietary notices contained on the materials. No material may be modified, edited or taken out of context such that its use creates a false or misleading statement or impression as to the positions, statements or actions.