



8x8 Garden in a Box Greenhouse Cover Assembly Manual

Thank you for purchasing a
8x8 Garden in a Box Greenhouse
Cover. Please take the time to identify
all the parts prior to assembly.

Version #2.0
July 19, 2019



In colder climates, please remove your Garden in a Box
Plastic Cover during the winter months and store in
included bag in a dry warm location.

Do not leave cover on during any large snow storms or
extreme weather phenomenon such as hurricanes,
tornadoes or heavy wind storms.

Cover can easily be taken off in minutes if such weather
patterns are forecast in your area.

We recommend once a year in the early spring to check
that all fasteners are snug and to tighten if loose.

Plastic cover can be cleaned with a mild soap and a cloth.











**Customer agrees to hold Outdoor Living Today
and any Authorized Dealers free of any liability
for improper installation, maintenance and
repair.**

In the event of a missing or broken piece, call the Outdoor Living Today Customer Support Line @ 1-888-658-1658 within 30 days of the delivery of your purchase. It is our commitment to you to courier replacement parts, free of charge, within 10 business days of this notification. Replacement parts will not be provided free of charge after the 30 day grace period.

All structures purchased from Outdoor Living Today are covered for a period of one year for defects in manufacturing and workmanship. Costs incurred for customer installations are not included.

Failure to use supplied parts included in this kit could result in poor product performance and may void your warranty. Please contact Outdoor Living Today's Customer Toll Free Line if you plan to deviate from our written instructions.

Thank you for purchasing our 8x8 Garden in a Box with Greenhouse Cover. Please take the time to identify all the parts prior to assembly.

Part 1		x 10
Part 2		x 5
Part 3		x 10
Part 4		x 5
Part 5		x 5
Part 6		x 8
Part 7		x 2
Part 8		x 2
Part 9		x 3
Part 10		x 2
Part 11		x 3

Hardware

& Miscellaneous

44 x S2 - 1 1/4" Screws



2 x M6x60



23 x M6x55



8 x M6x35



1 x BR1 - Square Drive Bit



20 x Y34 - Pipe Clamps



36 x Screw Caps



18 x Velcro Patches - Male



18 x Velcro Patches - Female

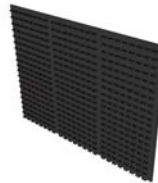

Storage Bag



Greenhouse Cover

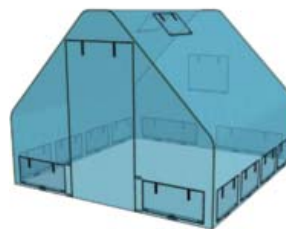

Tools Required

(Not Provided)



Screw Gun/Drill



Pliers



Phillips Screwdriver

Exploded View

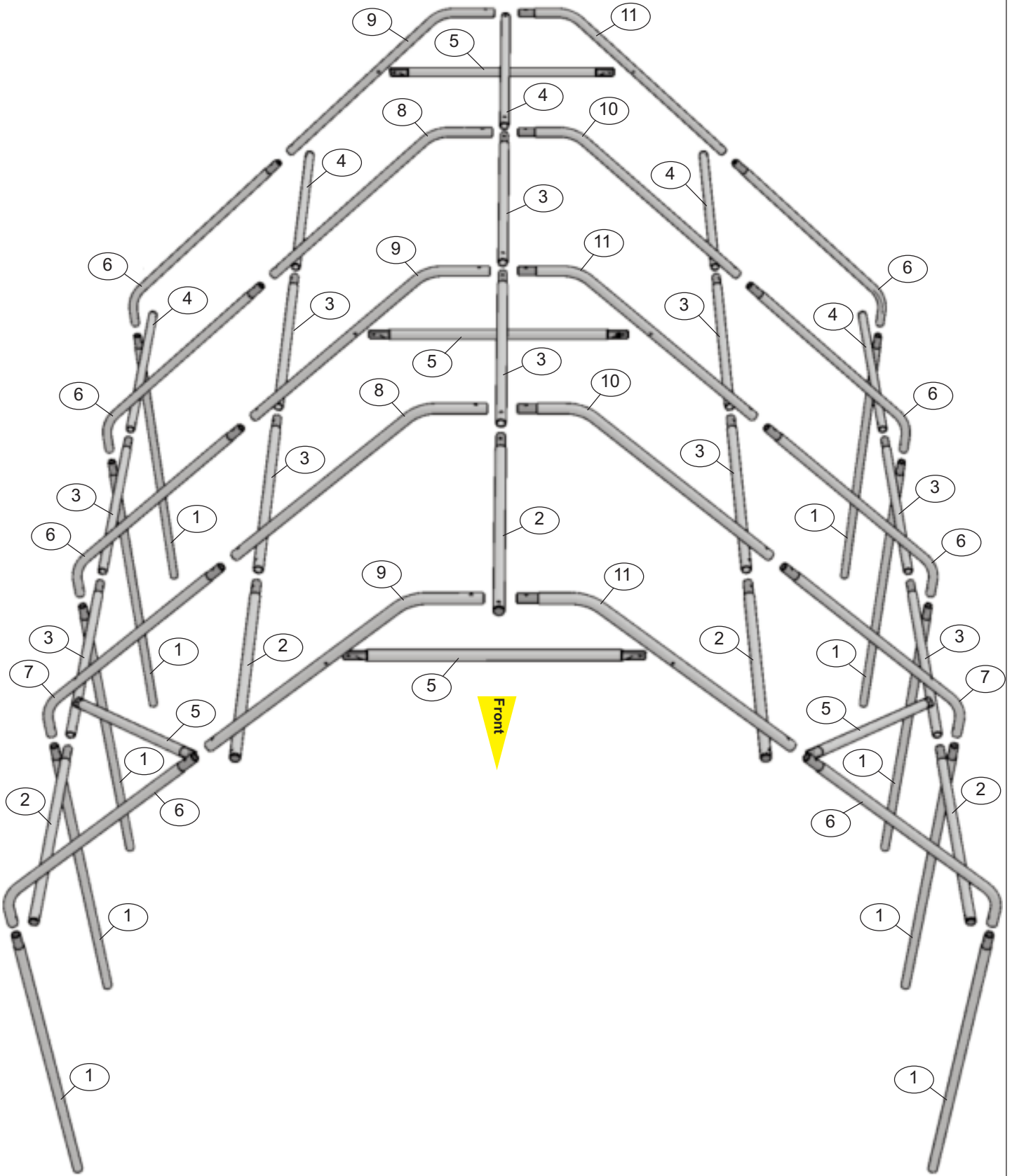

Step 1	Parts & Hardware	
	1 x Part 4	1 x Part 11
	1 x Part 9	1 x M6x55

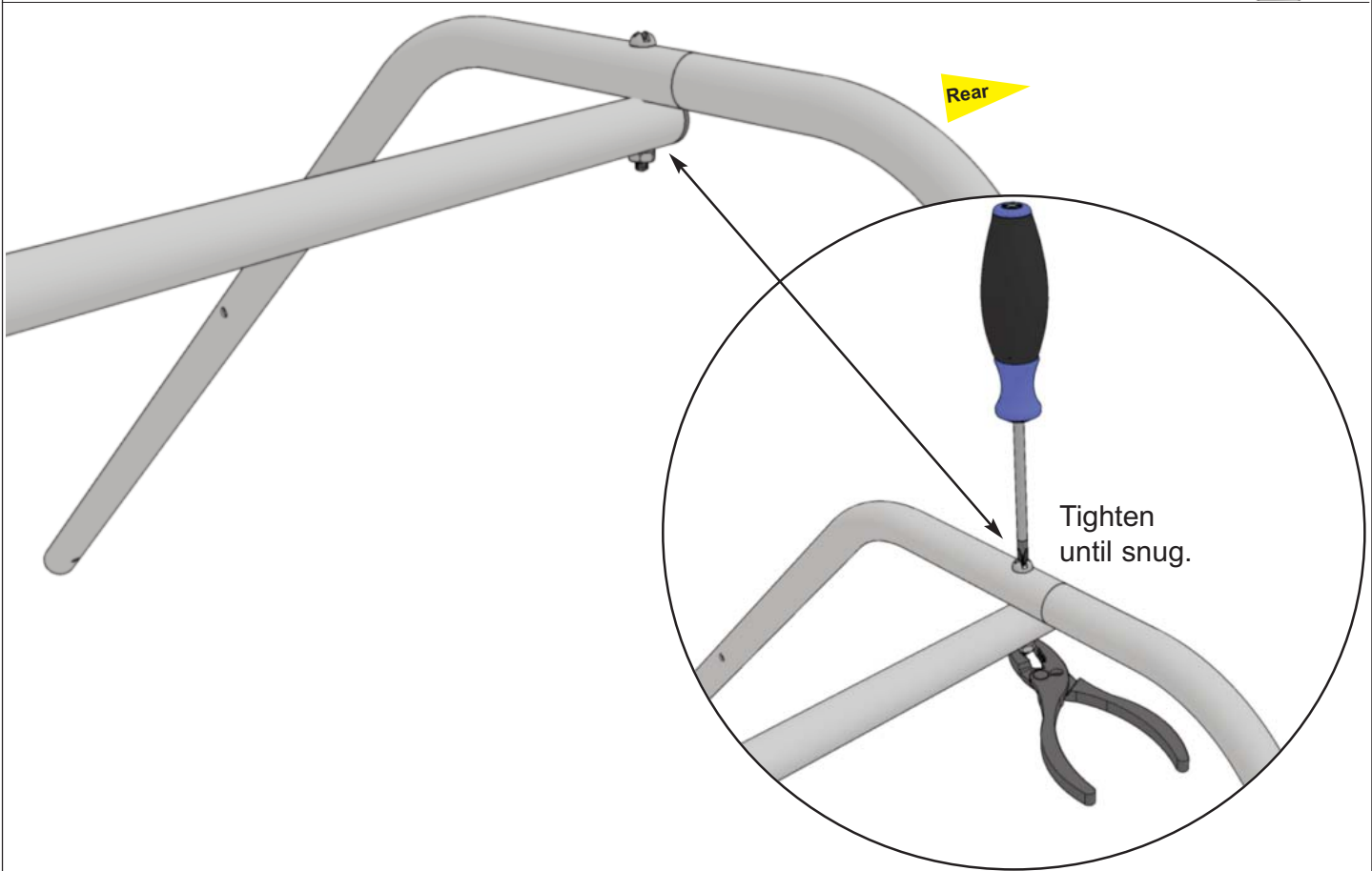
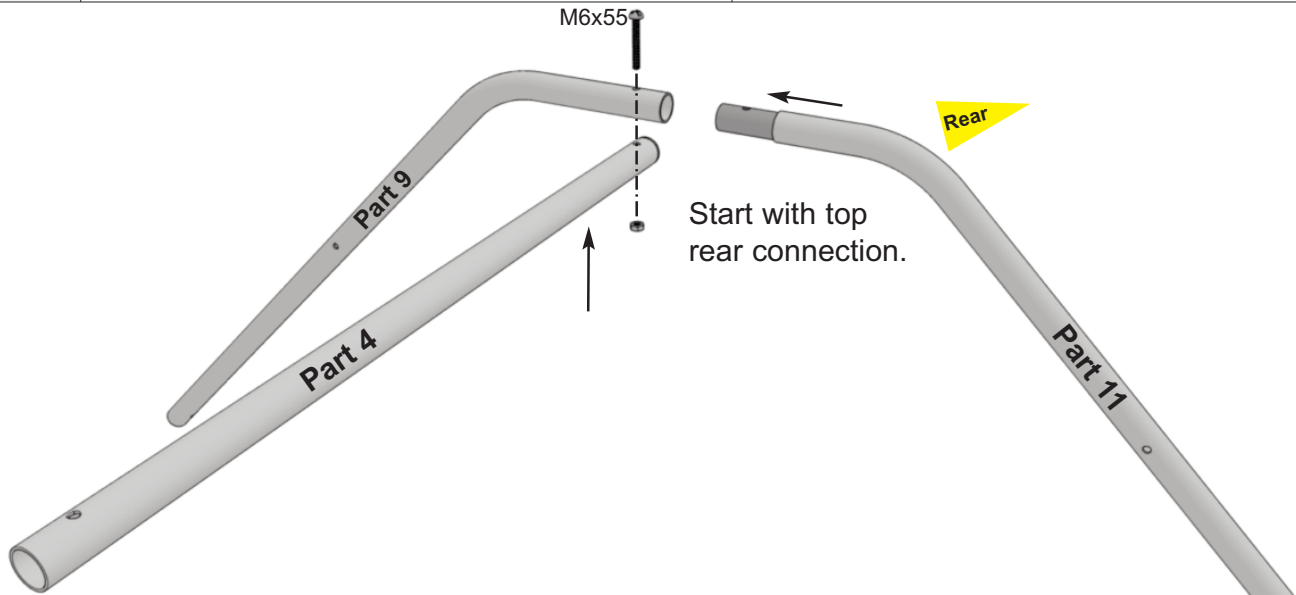

Step

2

Parts & Hardware

1 x Part 5



2 x M6x35

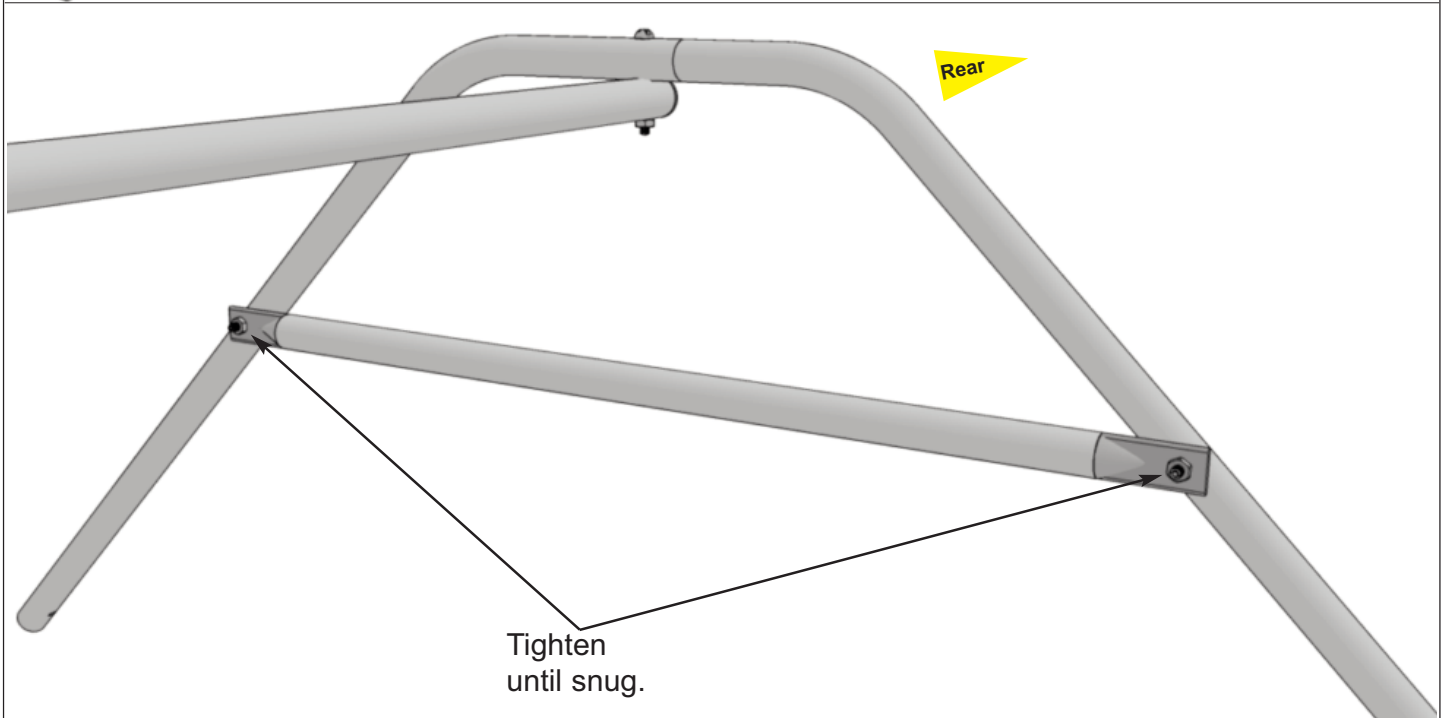
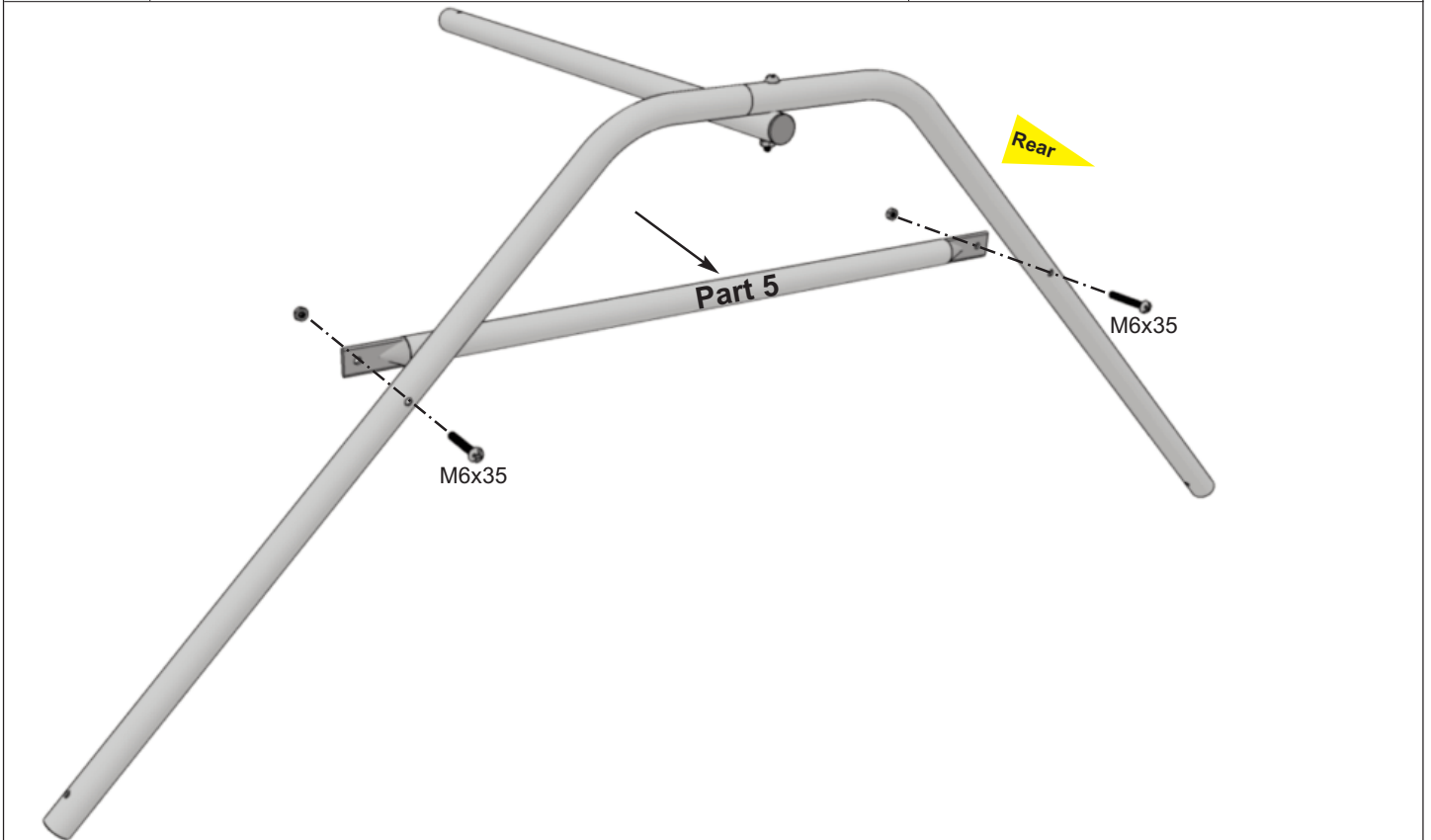

Step 3	Parts & Hardware	
	1 x Part 3	1 x Part 10
	1 x Part 8	1 x M6x55

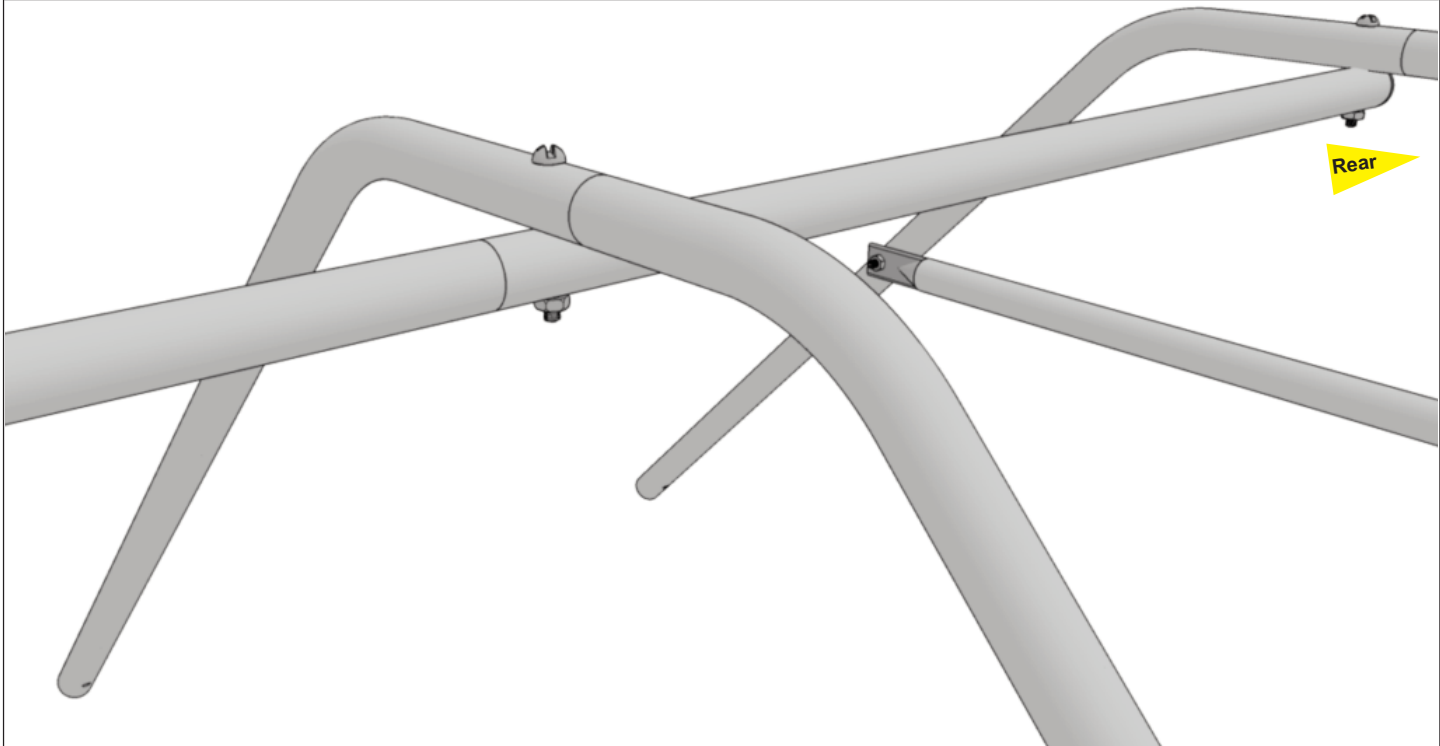
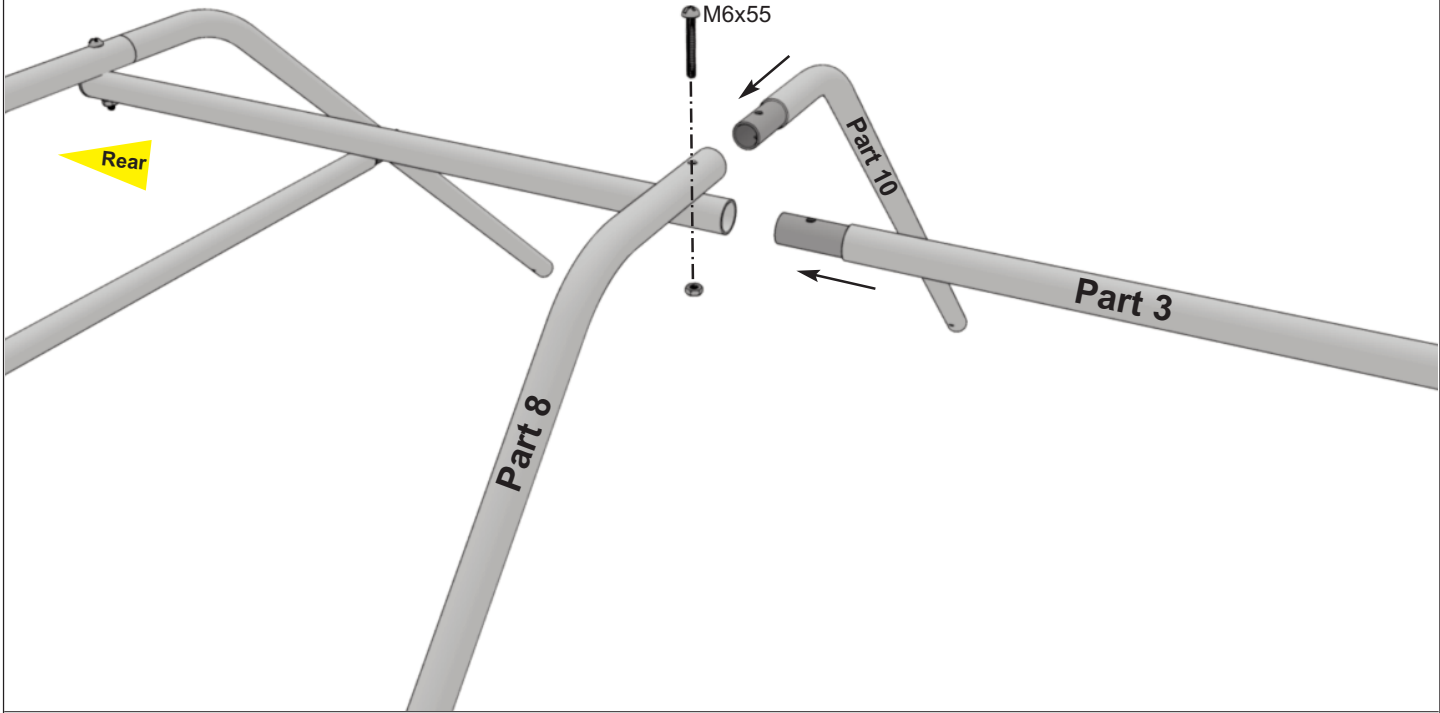

Step		Parts & Hardware			
		4	1 x Part 8	1 x Part 10	
1 x Part 2	1 x Part 3				
2 x Part 9	2 x Part 11				
11 x Screw Caps	4 x M6x35		3 x M6x55	2 x Part 5	

Front

Rear

Insert screw caps into the head of each screw to prevent the Greenhouse Cover from ripping in the future.

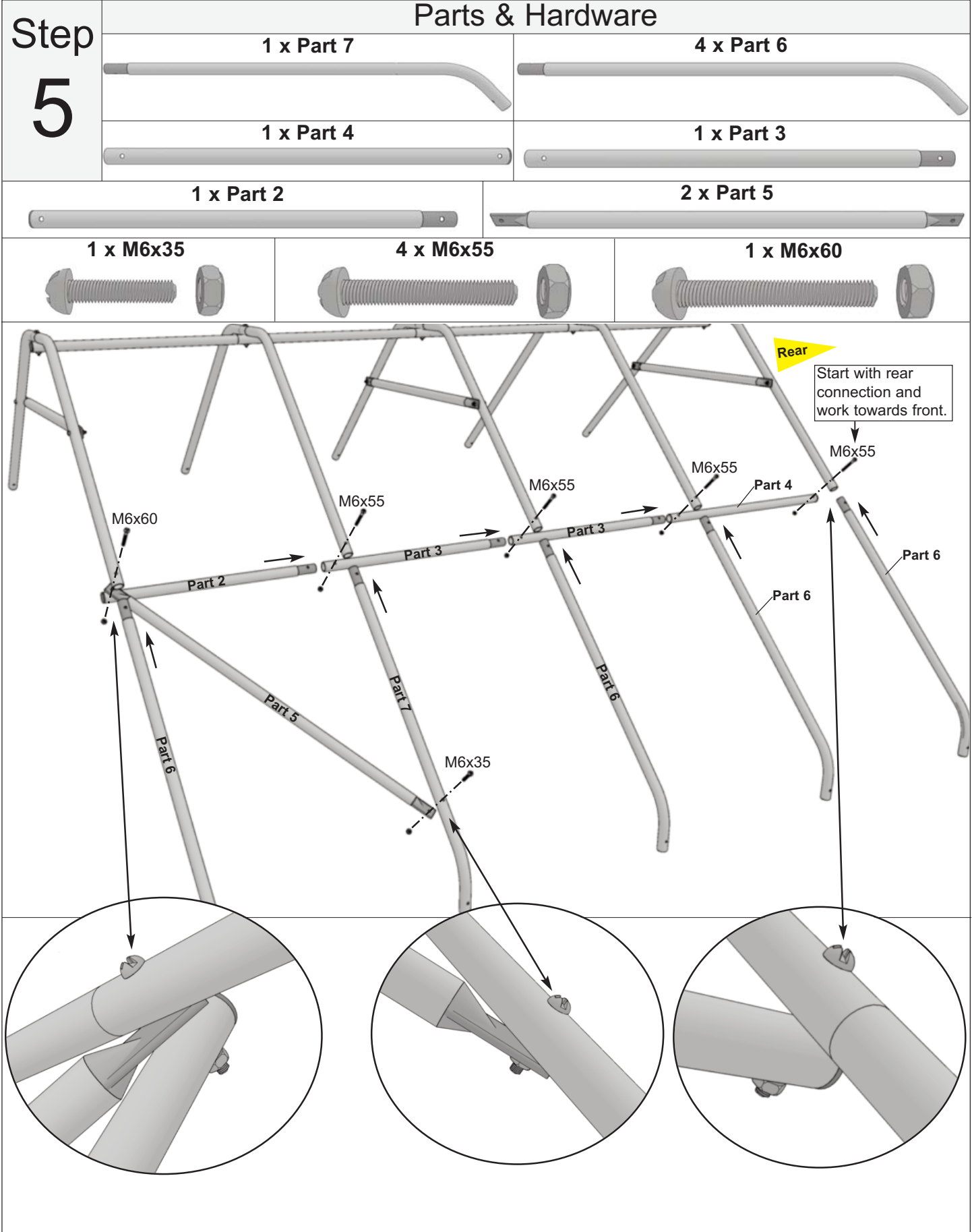

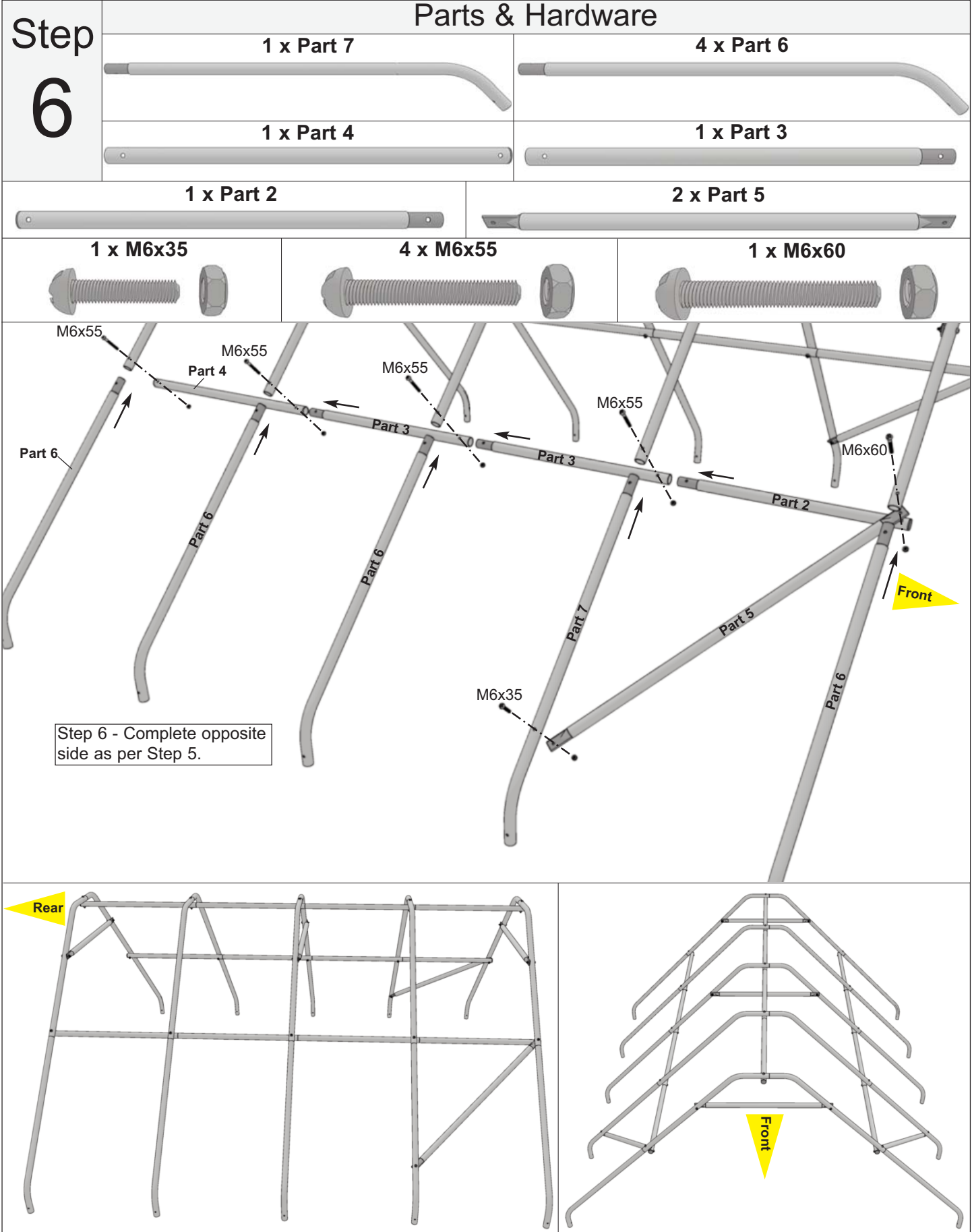

Step 7

Parts & Hardware

2 x Part 2

2 x Part 4

4 x Part 1

4 x M6x55

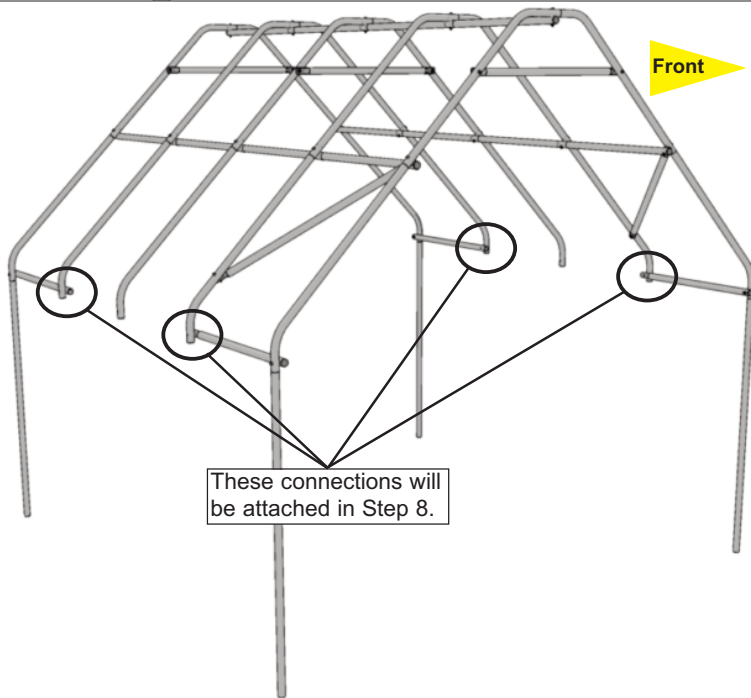
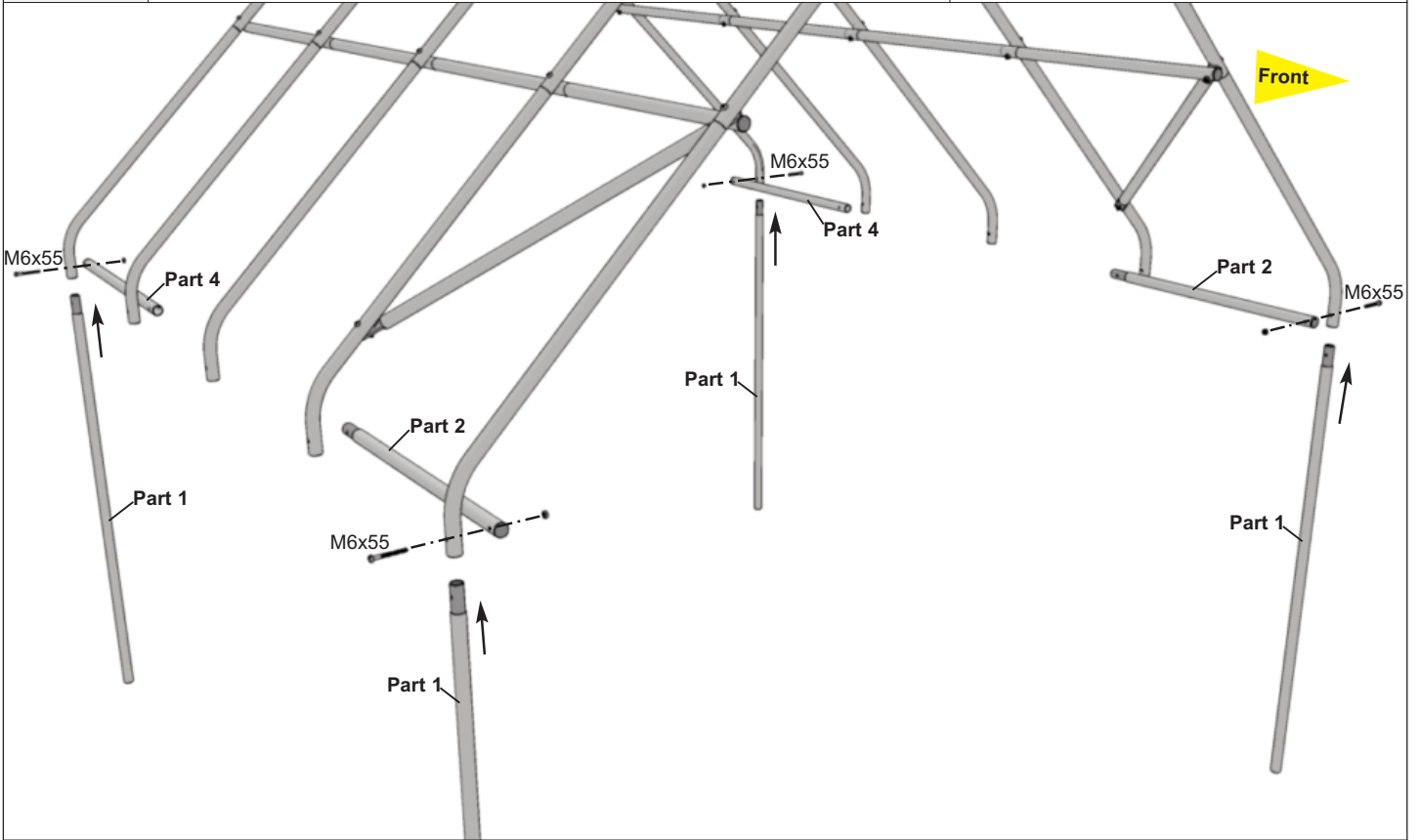

Step 8	Parts & Hardware	
	4 x Part 3	6 x M6x55
	6 x Part 1	

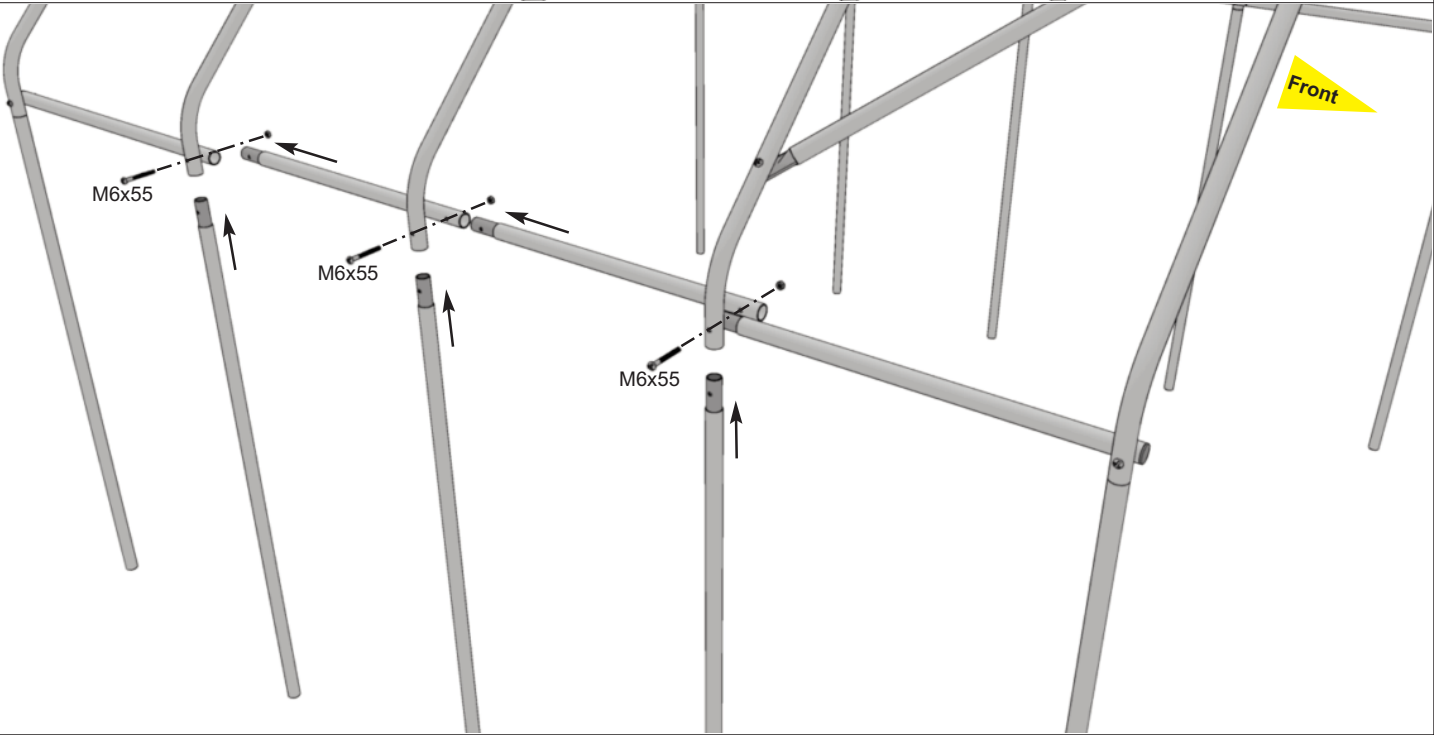
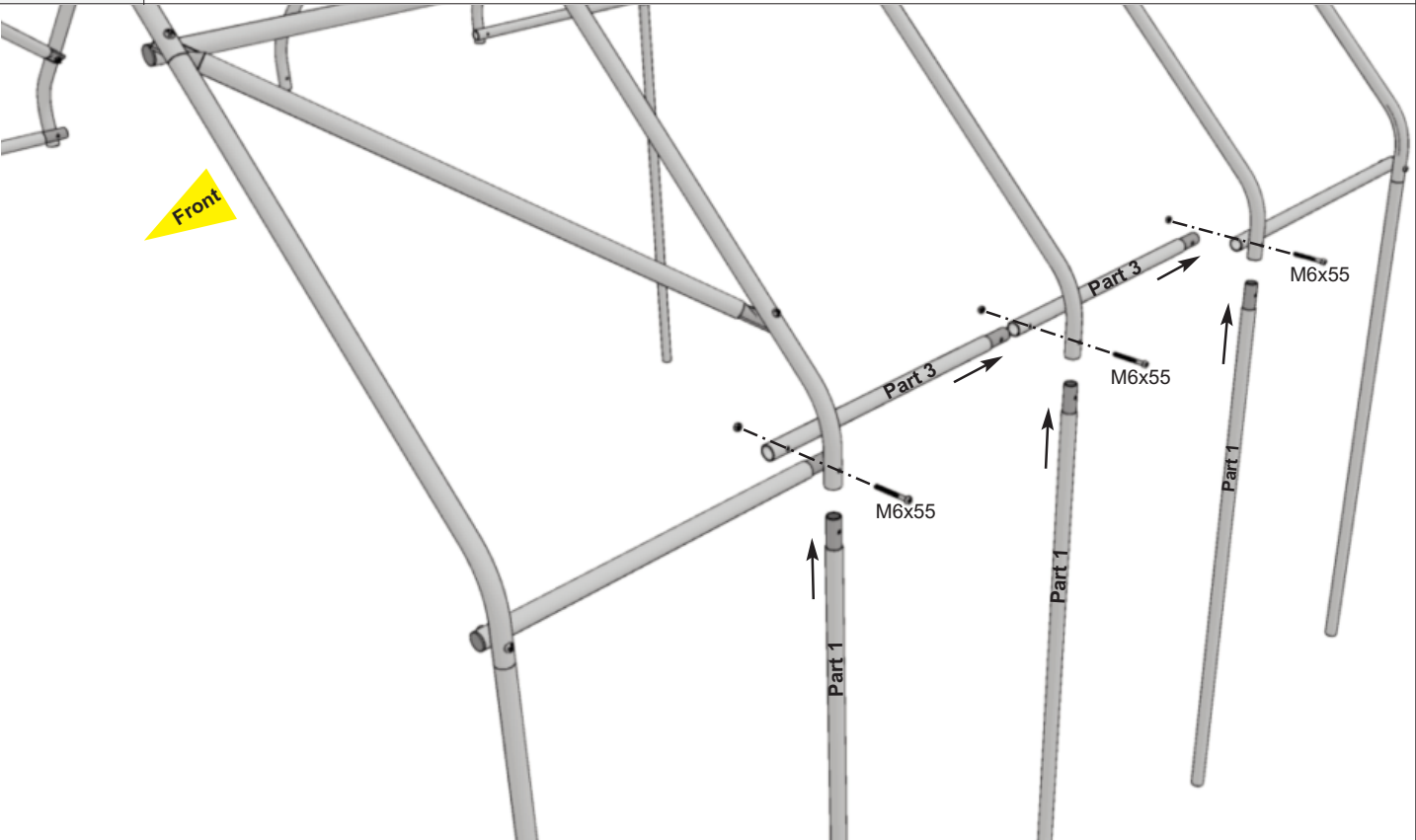

Step
9

Parts & Hardware

22 x Screw Caps

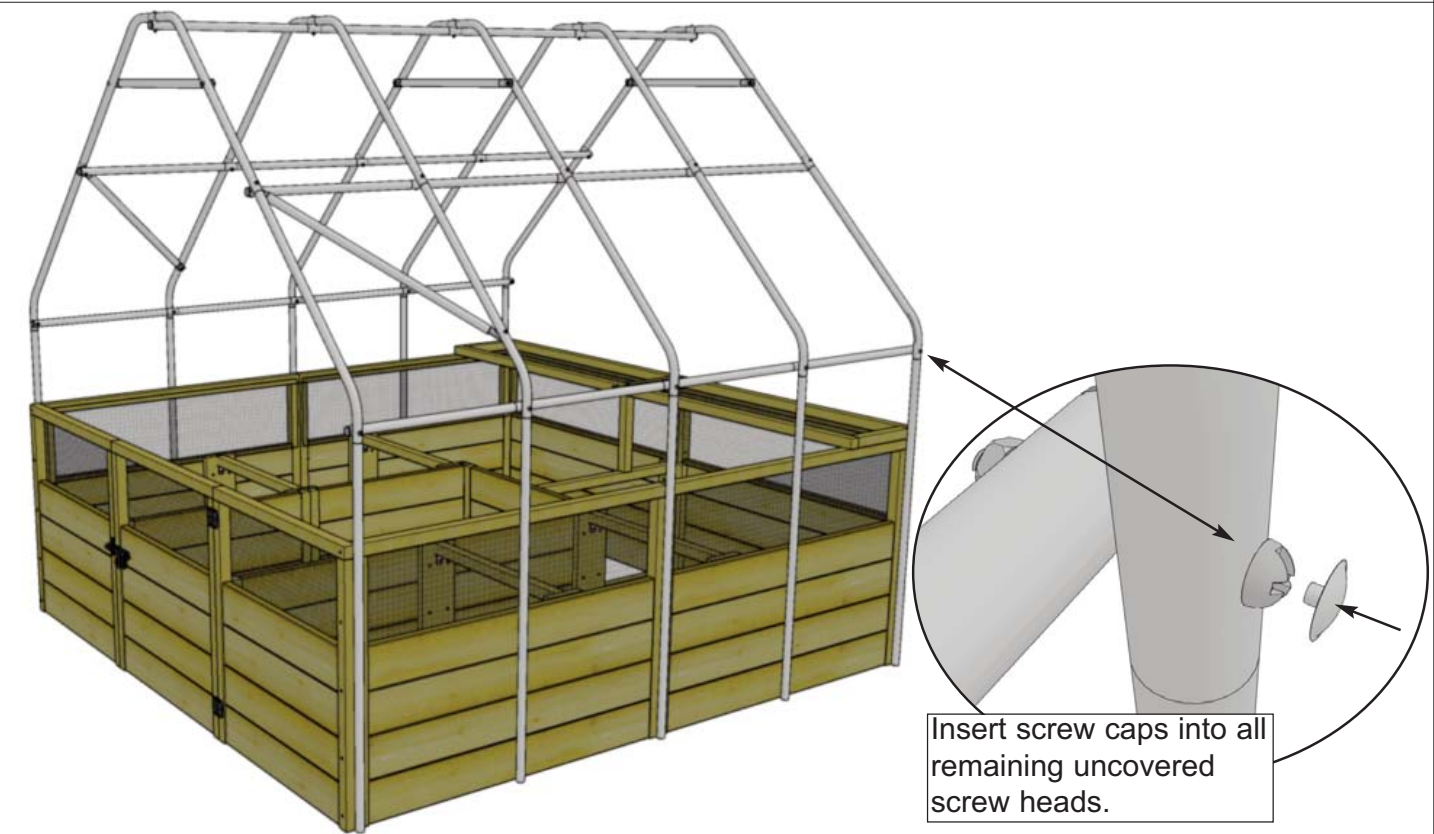
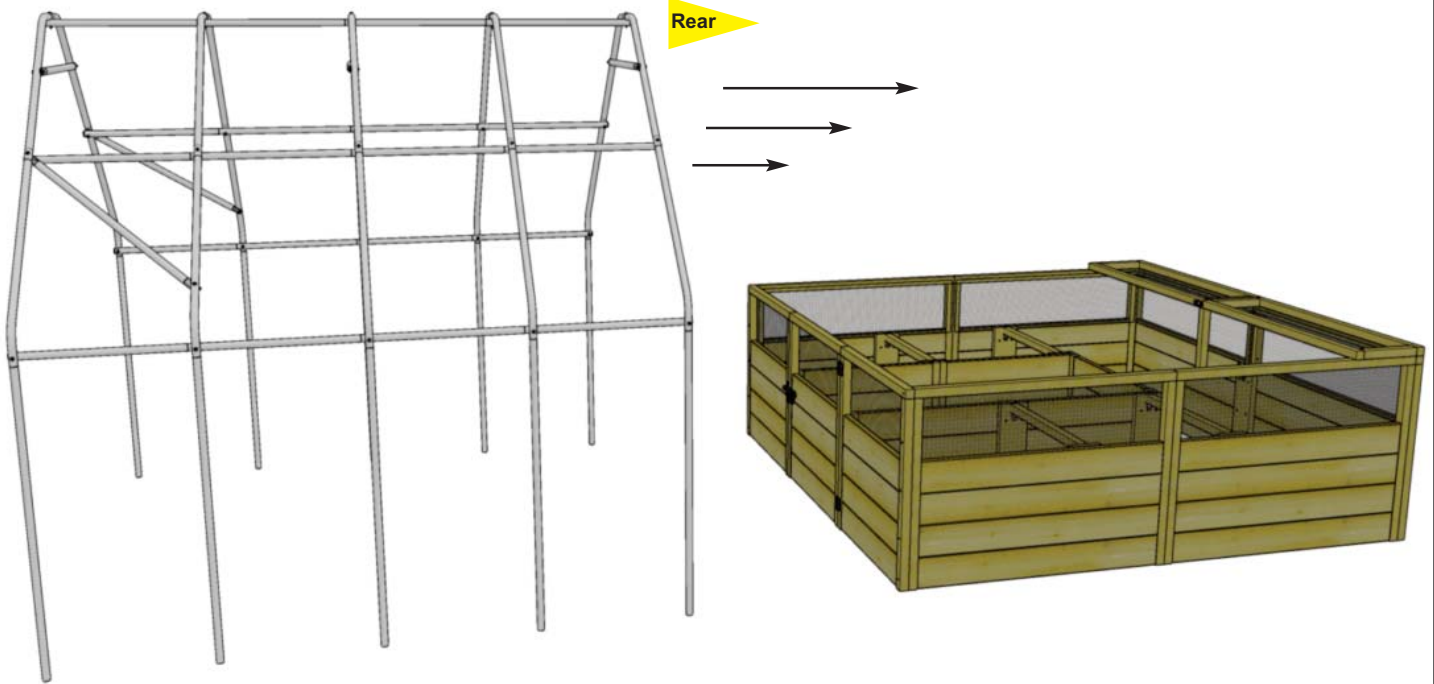
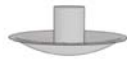

Step
10

Parts & Hardware

20 x Y34 - Pipe Clamps



40 x S2 - 1 1/4" Screws

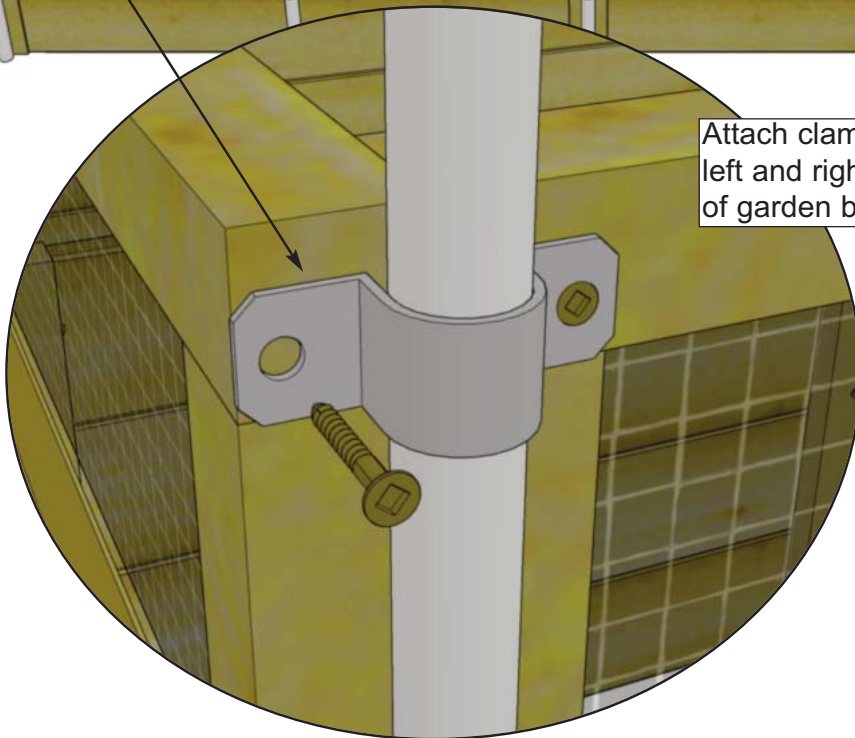
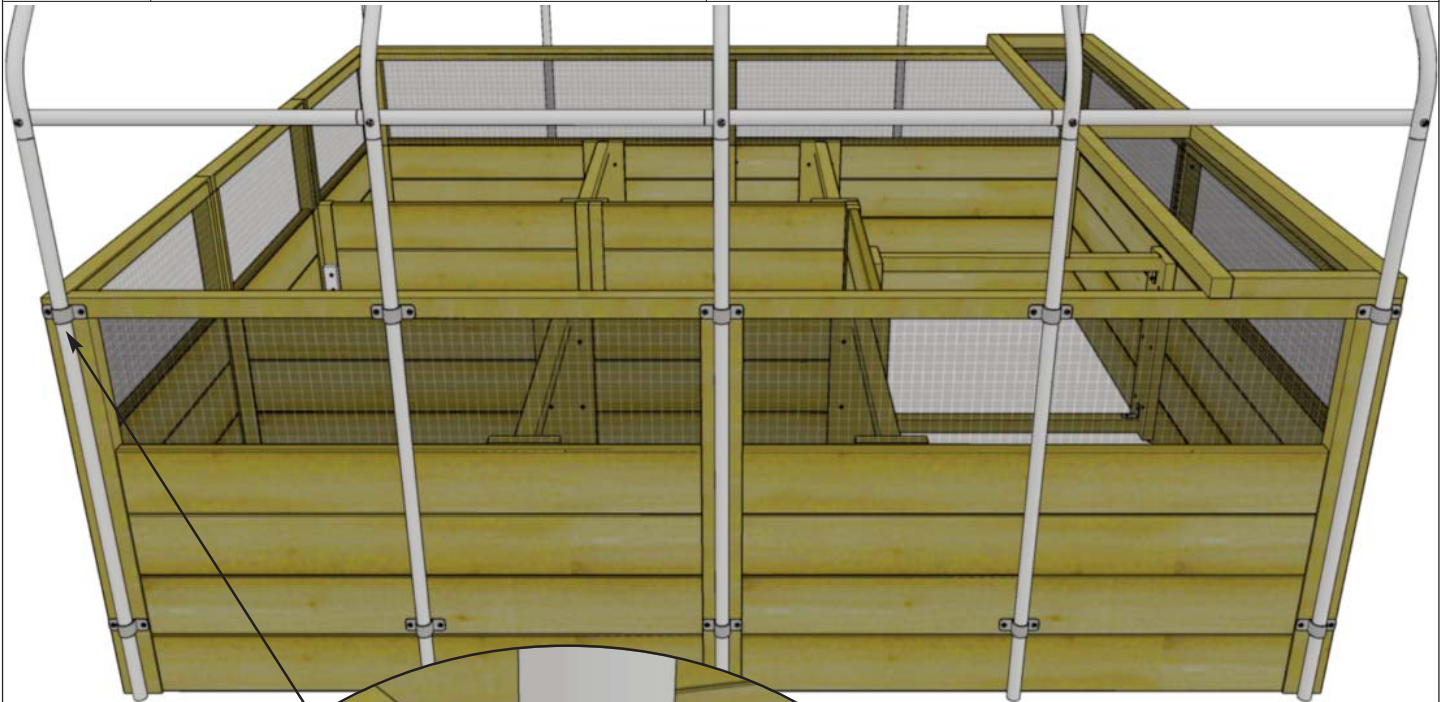

Attach clamps on
left and right side
of garden bed.

Step 11

Note: To fit the Greenhouse Cover on the frame, you will need to open the doorway of the cover.

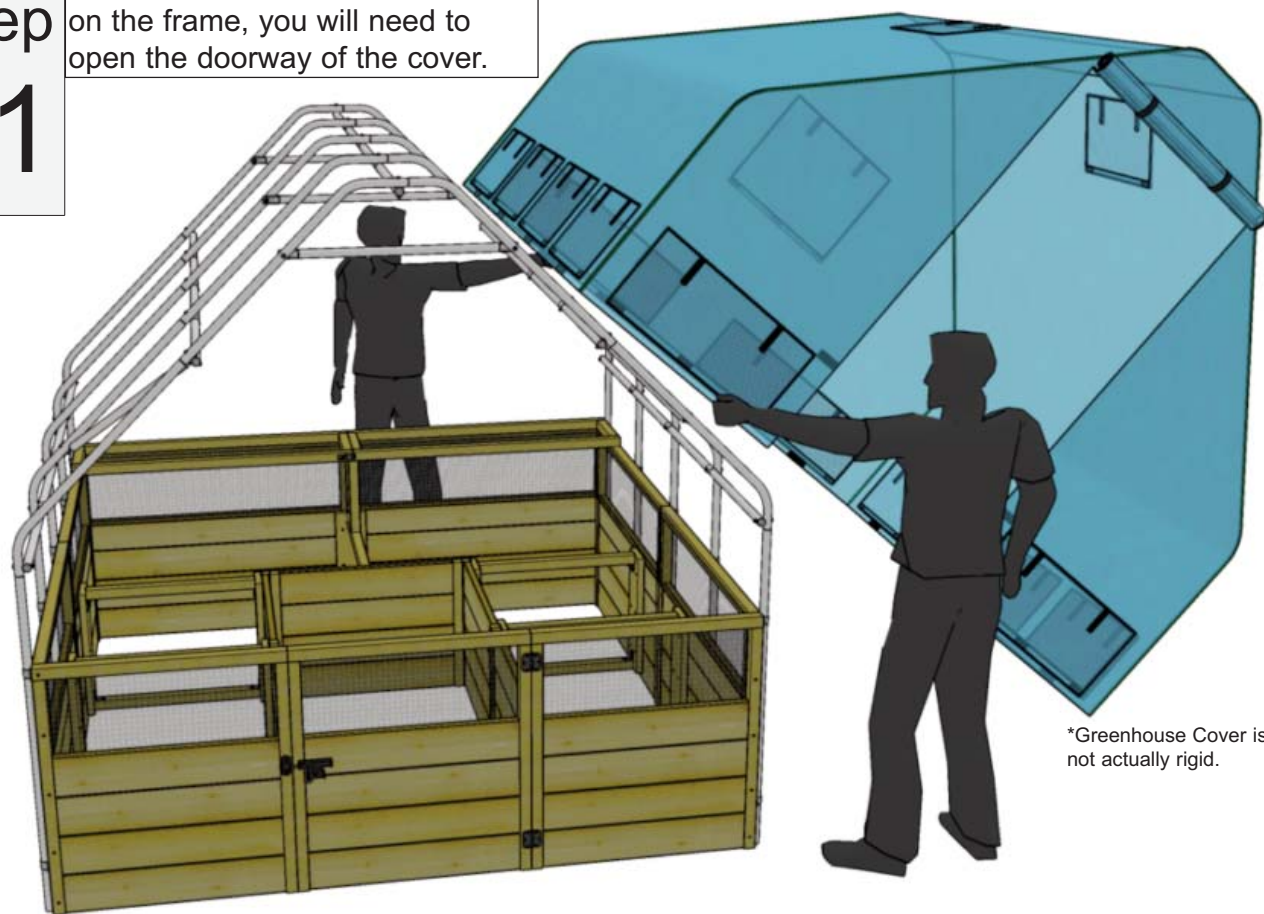

*Greenhouse Cover is not actually rigid.

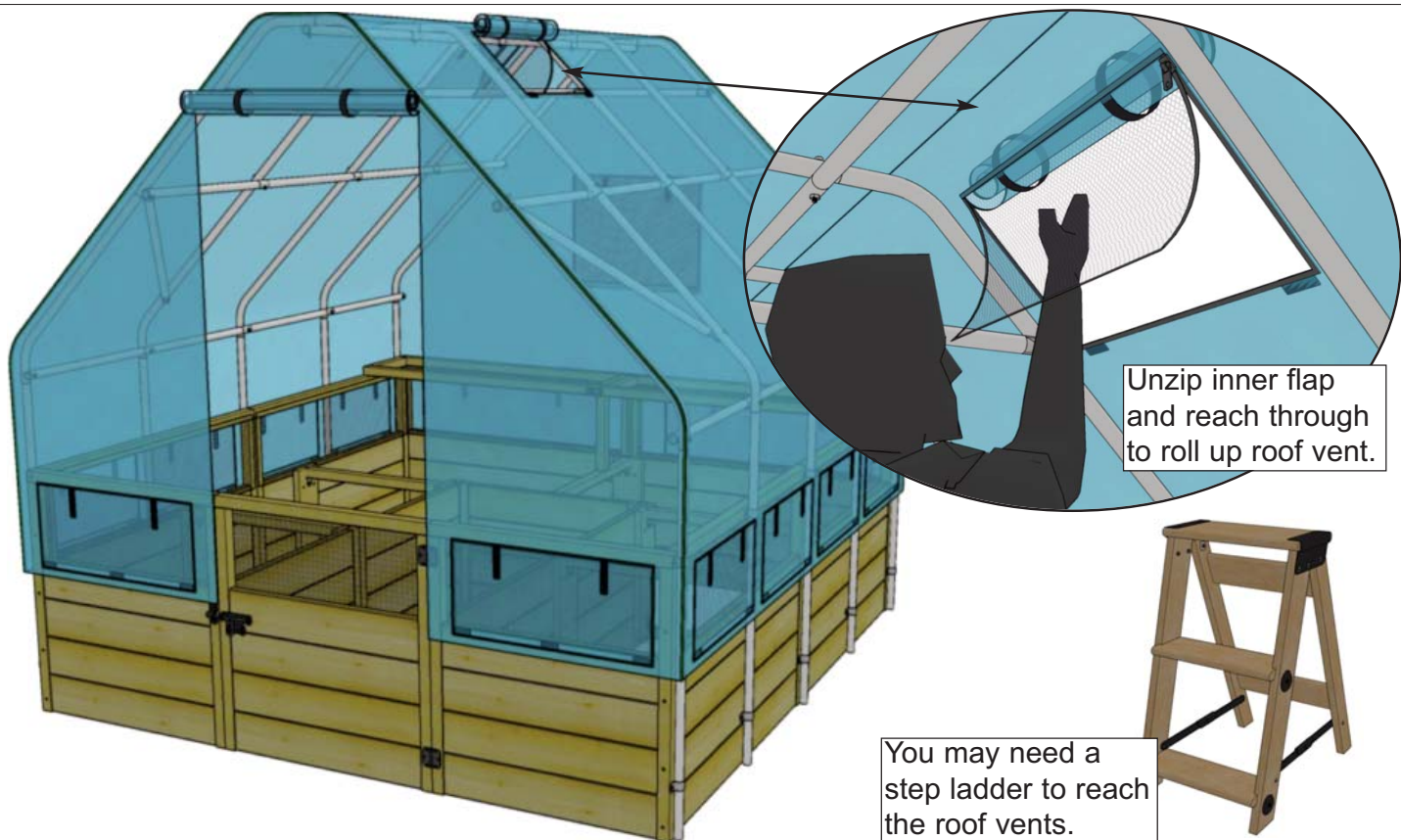

Unzip inner flap and reach through to roll up roof vent.

You may need a step ladder to reach the roof vents.

Step 12

Parts & Hardware

4 x Velcro Patches - Female

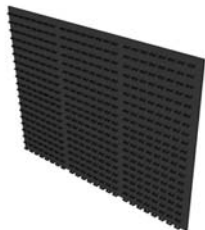

4 x Velcro Patches - Male



Right Side of Unit

Attach Velcro patches with adhesive backing to exterior of garden bed and interior of greenhouse cover.

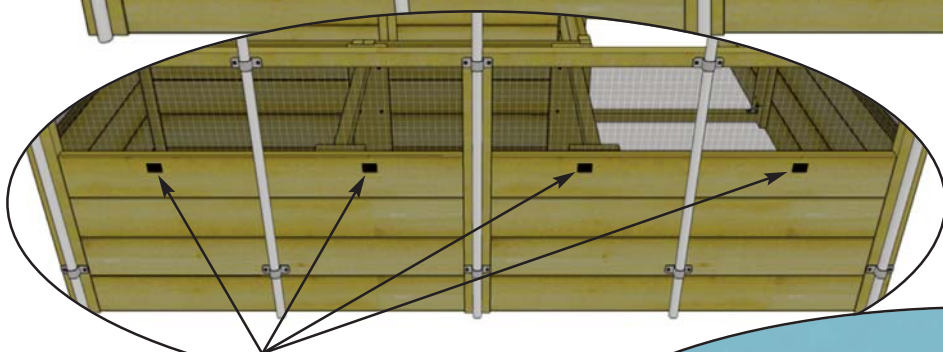
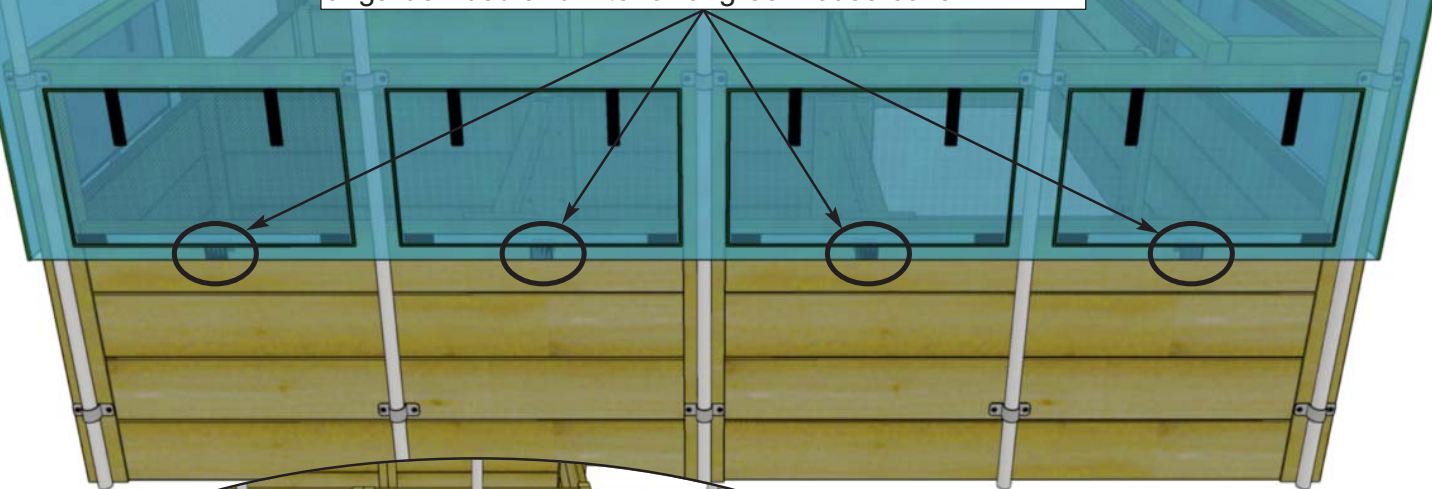

One Female Velcro patch centered under each side vent.

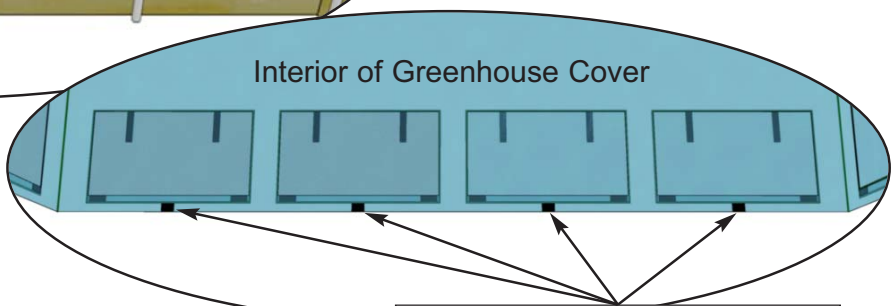

One Male Velcro patch centered under each side vent.

Step 13

Parts & Hardware

14 x Velcro Patches - Female



14 x Velcro Patches - Male



Rear of Unit

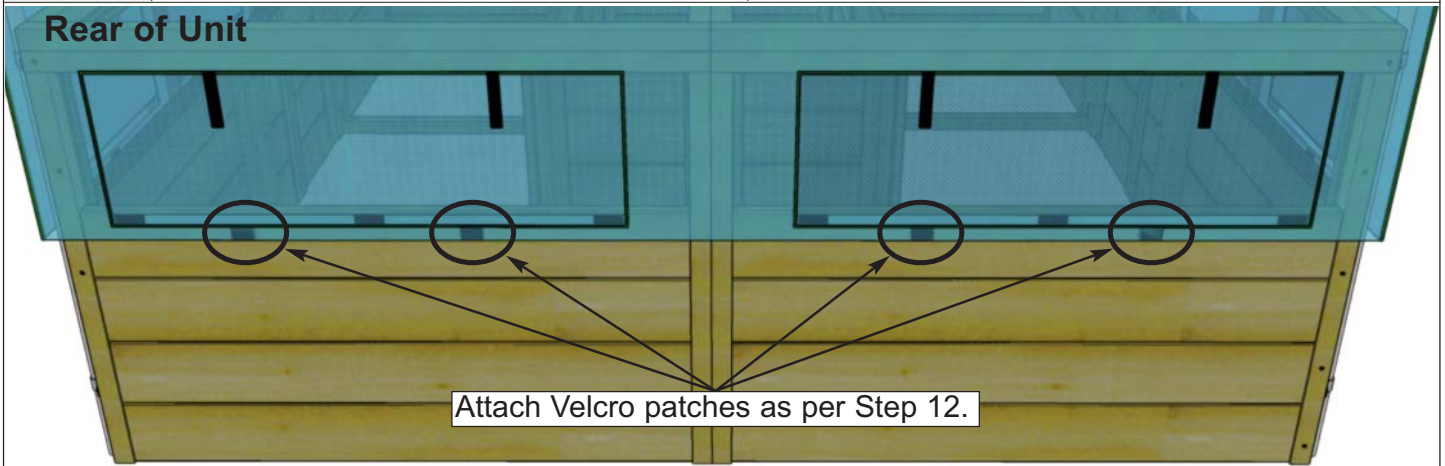

Left Side of Unit

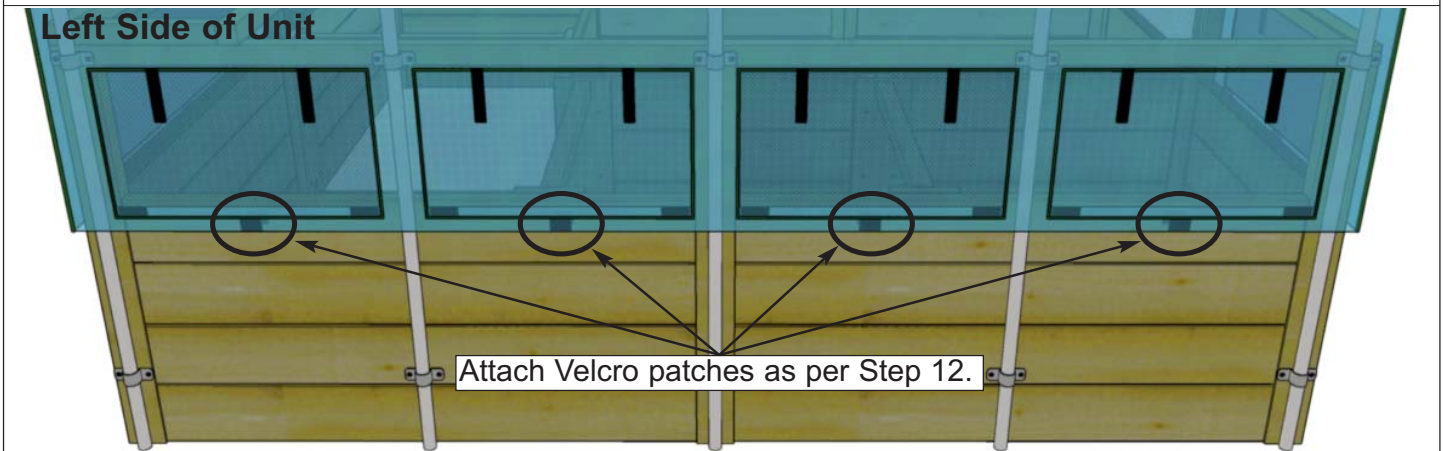

Front of Unit

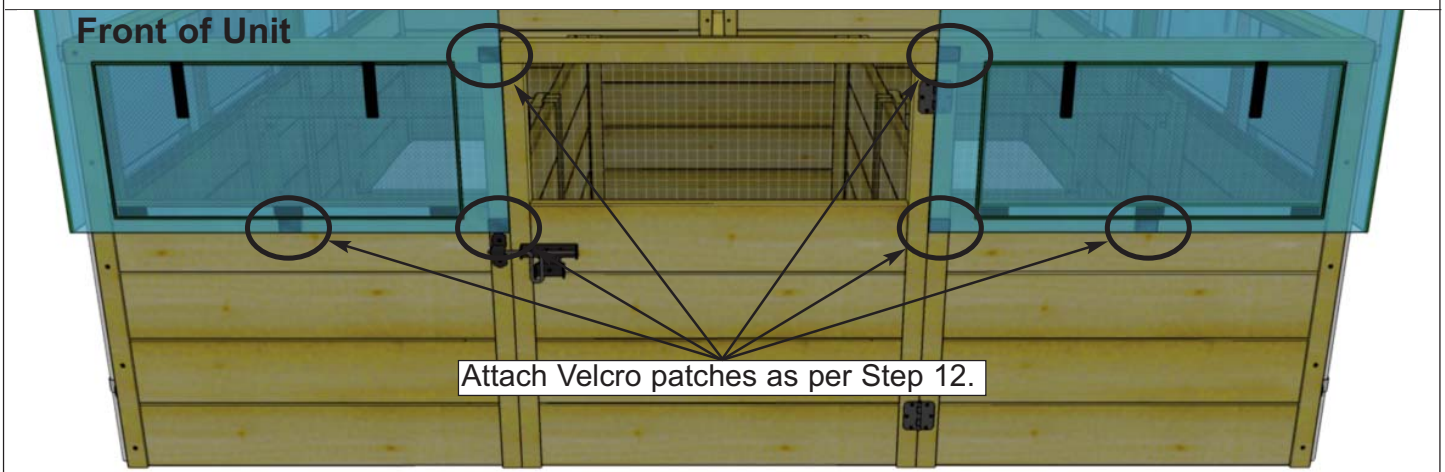



Congratulations on assembling your 8x8 Garden in a Box Greenhouse Cover!

We hope your experience assembling your 8x8 Garden in a Box Greenhouse Cover has been both positive and rewarding.

We value your feedback and would like to hear back from you on how well we are doing in the following areas:

1. **Customer Service**
2. **On Time Shipping**
3. **Motor Freight Delivery**
4. **Quality of Materials**
5. **Assembly Manual**
6. **Overall Satisfaction.**



Please call, write or email us at:

Outdoor Living Today

Canadian Address
9393 287th Street
Maple Ridge, British Columbia
Canada V2W 1L1

United States Address
P.O. Box 96
Sumas, Washington
USA 98295



The materials contained in this Assembly Manual may be downloaded or copied provided that ALL copies retain the copyright and any other proprietary notices contained on the materials. No material may be modified, edited or taken out of context such that its use creates a false or misleading statement or impression as to the positions, statements or actions.